

Hermetic Packages

National Semiconductor offers a wide variety of ceramic and metal can packages for through-hole and surface mount applications. These ceramic and metal can packages are offered as solutions for high reliability and often high performance applications, and are extensively used in military/aerospace and commercial applications. By design, a hermetic seal prevents gases and liquids from entering the package cavity where the die is mounted. Because of the package materials, hermetic packages are able to withstand higher temperatures than the equivalent plastic packages.

The construction of hermetic packages can be divided into three main categories: multilayer ceramic packages, pressed ceramic packages, and metal can packages.

Multilayer Ceramic Packages

For multilayer packages, ceramic tape layers are metallized, laminated and then fired to create the package body. Leads are then brazed to the package body. The metallized areas of the package are then electroplated (usually nickel followed by gold). After assembly, the hermetic seal is achieved by soldering a metal lid onto the metallized and plated seal ring. These packages therefore are often referred to as solder seal packages.

The multilayer construction allows the package designer to incorporate electrical enhancements within the package body. For example, power and ground planes to reduce inductance, shield planes to reduce cross talk, and controlled characteristic impedance of signal lines have been incorporated into multilayer ceramic packages.

Pressed Ceramic Packages

Pressed ceramic packages are usually a three part construction: base, lid and leadframe. The base and lid are manufactured in the same manner by pressing ceramic powder into the desired shape and then firing. Glass is then screened onto the fired base and lid. The glass paste is then fired. During package assembly, a separate leadframe is embedded into the base glass. The hermetic seal is then formed by melting the lid glass over the base and leadframe combination. This seal method is referred to as a frit seal, and therefore this package is often called a glass frit seal package.

The pressed ceramic packages are typically lower in cost than the multilayer packages. However, the simple construction does not allow for many electrical enhancements.

Metal Can Packages

Metal can packages consist of a metal base with leads exiting through a glass seal. This glass seal can be a compression seal or a matched seal. After device assembly in the package, a metal lid (or can) is resistance welded to the metal base forming the hermetic seal. The metal can packages are usually low leadcount, less than 24 leads, and low in cost. Certain outlines, such as the TO-3, have very low thermal resistance. These packages are used in many linear and hybrid applications.

Hermetic Package Configuration

National offers DIP configurations in the pressed ceramic (Cerdip) package style as well as the multilayer ceramic sidebrazed (SB) package. Other through hole package styles are the metal can packages (TO) and the ceramic pin grid array (CPGA) packages.

Many ceramic surface mount packages are offered by National. Dual in line packages such as the pressed ceramic Cerpack, and the multilayer ceramic flatpack are available in the lower leadcounts. These packages typically have a lead pitch of 50 mils. Applications requiring higher lead density use quad packages such as the multilayer ceramic quad flatpack (CQFP) and the pressed ceramic Cerquad. Lead pitch of 25 or 20 mils (or the metric equivalent 0.65 mm and 0.50 mm) are most common for the quad packages.

The following table provides configuration and characteristic data regarding each of the ceramic and metal can packages offered by National.

Package Configuration

Ceramic Sidebraced Dual-In-line Package (SB)

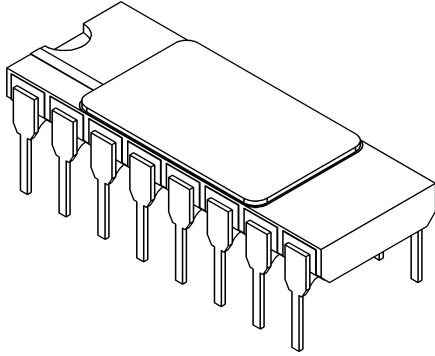

Package Characteristics

- Through Hole Package
- Brazed Straight Leads to Pads on Package Side
- Gold Plate or Solder Dip Lead Finish
- Multilayer Ceramic Package
- Solder Seal
- Footprint Compatible with Cerdip and MDIP

Ceramic Leadless Chip Carrier (LCC)

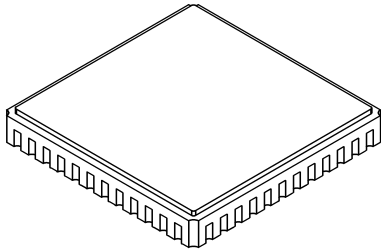

- Surface/Socket Mount Package
- Terminal Pads Instead of Leads
- Gold Plate or Solder Dip Lead Finish
- Multilayer Ceramic Package
- Solder Seal
- Footprint Compatible with CQJB and PLCC

Ceramic Quad J-Bend (CQJB)

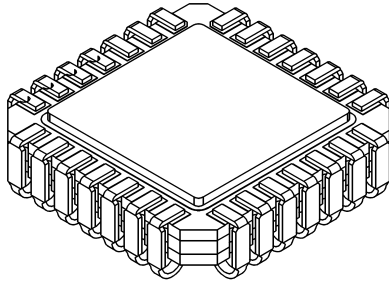

- Surface Mount Package
- J-Bend Lead Configuration
- Gold Plate Lead Finish
- Multilayer Ceramic Package
- Solder Seal
- Footprint Compatible with LCC and PLCC

Ceramic Quad Flatpack (CQFP)

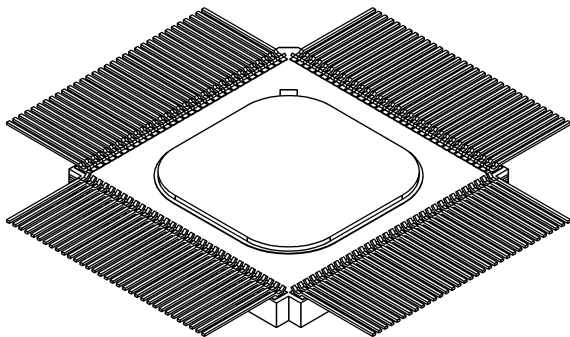

- Surface Mount Package
- Straight Lead Configuration
- Gold Plate Lead Finish
- Multilayer Ceramic Package
- Solder Seal

(Continued)

Package Configuration

Package Characteristics

Ceramic Flatpack

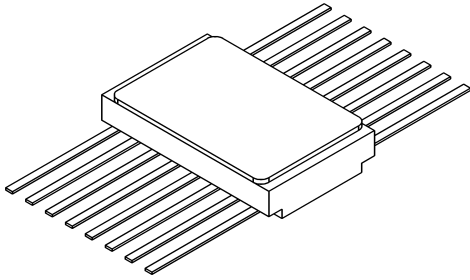

- Surface Mount or Through Hole Package
- Straight Lead Configuration
- Gold Plate Lead Finish
- Multilayer Ceramic Package
- Solder Seal
- Footprint Compatible with Cerpack

Ceramic Dual-In-Line Package (Cerdip)

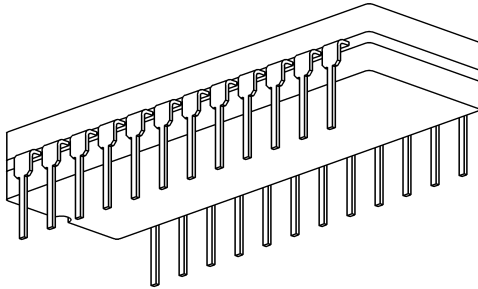

- Through Hole Package
- Straight Lead Configuration
- Solder Dip Lead Finish
- Pressed Ceramic Package
- Glass Seal
- Footprint Compatible with SB and MDIP

Ceramic Small Outline Package

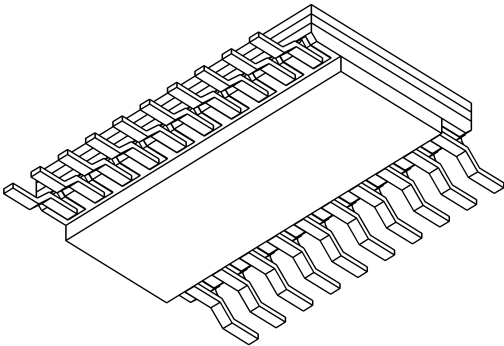

- Surface Mount Package
- Gull Wing Lead Configuration
- Gold Plate Lead Finish
- Multilayer Ceramic Package
- Solder Seal
- Footprint Compatible with Wide Body Plastic SOP

Ceramic Pin Grid Array (CPGA)

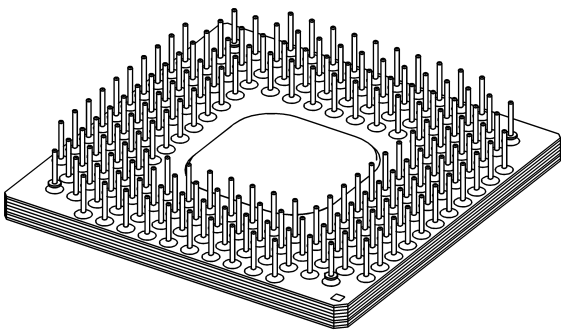

- Through Hole Package
- Straight Lead Configuration
- Gold Plate Lead Finish
- Multilayer Ceramic Package
- Solder Seal
- Footprint Compatible with PPGA

(Continued)

Package Configuration

Package Characteristics

Cerpack

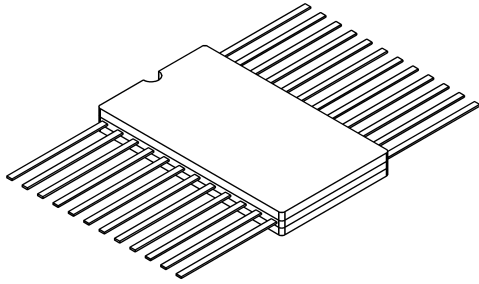

- Surface Mount or Through Hole Package
- Straight Lead Configuration
- Solder Dip Lead Finish
- Pressed Ceramic Package
- Glass Seal
- Footprint Compatible with Flatpak

Cerquad

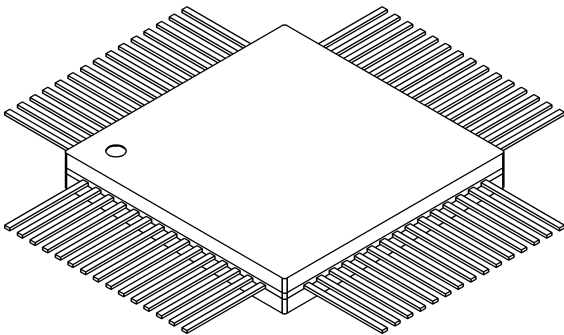

- Surface Mount Package
- Straight Lead Configuration
- Solder DIP or Tin Plate Lead Finish
- Pressed Ceramic Package
- Glass Seal
- Footprint Compatible with PQFP
- Can be Electrically and/or Thermally Enhanced

Cerquad — EIAJ

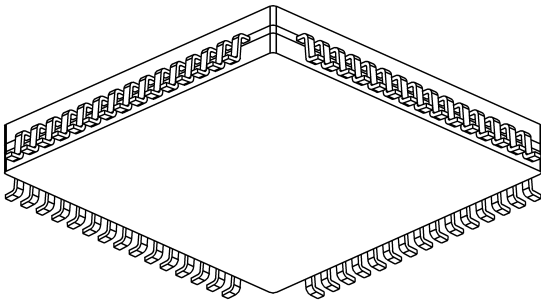

- Surface Mount Package
- Gull Wing Lead Configuration
- Solder DIP or Tin Plate Lead Finish
- Pressed Ceramic Package
- Glass Seal
- Footprint Compatible with PQFP
- Can be Electrically and/or Thermally Enhanced

**TO-3
Metal Can**

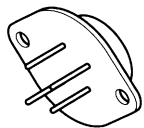

- Through Hole Package
- Solder Dip Lead Finish
- Steel or Aluminum Base
- Compression Glass Seal

(Continued)

Package Configuration

Package Characteristics

**TO-5 and TO-39
Metal Can**

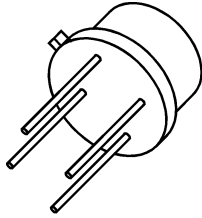

- Through Hole Package
- Solder Dip or Gold Plate Lead Finish TO-5
- Kovar Base
- Matched Glass Seal TO-39
- Kovar or Steel Base
- Matched or Compression Glass Seal

**TO-18
Metal Can**

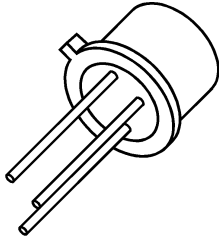

- Through Hole Package
- Solder DIP or Gold Plate Lead Finish
- Kovar Base
- Matched Glass Seal

**TO-46, TO-52 and TO-72
Metal Can**

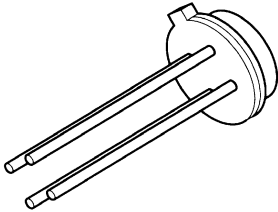

- Through Hole Package
- Solder Dip or Gold Plate Lead Finish
- Kovar or Steel Base
- Matched or Compression Glass Seal

(Continued)

LIFE SUPPORT POLICY

NATIONAL'S PRODUCTS ARE NOT AUTHORIZED FOR USE AS CRITICAL COMPONENTS IN LIFE SUPPORT DEVICES OR SYSTEMS WITHOUT THE EXPRESS WRITTEN APPROVAL OF THE PRESIDENT AND GENERAL COUNSEL OF NATIONAL SEMICONDUCTOR CORPORATION. As used herein:

1. Life support devices or systems are devices or systems which, (a) are intended for surgical implant into the body, or (b) support or sustain life, and whose failure to perform when properly used in accordance with instructions for use provided in the labeling, can be reasonably expected to result in a significant injury to the user.
2. A critical component is any component of a life support device or system whose failure to perform can be reasonably expected to cause the failure of the life support device or system, or to affect its safety or effectiveness.

 <p>National Semiconductor Corporation Americas Tel: 1-800-272-9959 Fax: 1-800-737-7018 Email: support@nsc.com</p> <p>www.national.com</p>	<p>National Semiconductor Europe</p> <p>Fax: +49 (0) 1 80-530 85 86 Email: europe.support@nsc.com</p> <p>Deutsch Tel: +49 (0) 1 80-530 85 85 English Tel: +49 (0) 1 80-532 78 32 Français Tel: +49 (0) 1 80-532 93 58 Italiano Tel: +49 (0) 1 80-534 16 80</p>	<p>National Semiconductor Asia Pacific Customer Response Group</p> <p>Tel: 65-2544466 Fax: 65-2504466 Email: sea.support@nsc.com</p>	<p>National Semiconductor Japan Ltd.</p> <p>Tel: 81-3-5639-7560 Fax: 81-3-5639-7507</p>
--	---	---	--