

REV. T

-D (DOUBLE END)
FIGURE 1

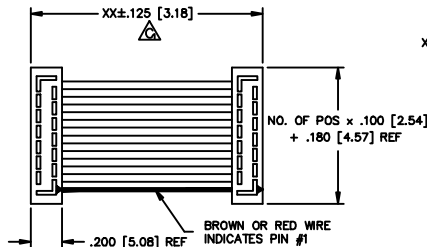

-S (SINGLE END)
SAME AS FIG. 1 UNLESS OTHERWISE SHOWN

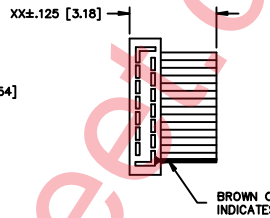

-T (TRANSFER END)
SEE NOTE 3
SAME AS FIG. 1 UNLESS OTHERWISE SHOWN

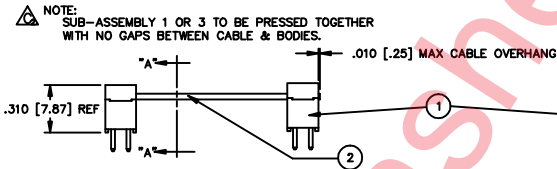
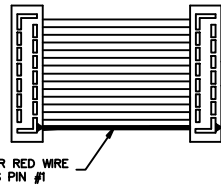

-RW
REVERSE WIRING

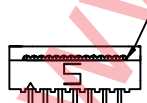

SECT. "A-A"

Do not scale from this print

PROPRIETARY NOTE
THE INFORMATION CONTAINED HEREIN IS THE PROPERTY OF SAMTEC AND IS TO BE USED ONLY FOR THE PURPOSES SPECIFIED. IT IS TO BE KEPT CONFIDENTIAL AND NOT TO BE REPRODUCED OR TRANSMITTED IN ANY FORM OR BY ANY MEANS, ELECTRONIC OR MECHANICAL, INCLUDING PHOTOCOPYING, RECORDING, OR BY ANY INFORMATION STORAGE AND RETRIEVAL SYSTEM.

-G
GRAY CABLE

SUBSTITUTE GRAY CABLE FOR STANDARD COLOR CODED CABLE
USE: CB-XX-28-7/36-050-G

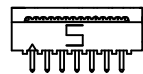

NOTE:
USE GRAY CABLE FOR -32 AND -36 POSITIONS.

-ST"X"
STRIPPED & TINNED

"X"	LENGTH
8	.125 [3.18]
4	.250 [6.35]
3	.375 [9.53]
2	.500 [12.70]

NOTE:
1. CONDUCTORS SHALL BE CONSISTENT IN APPEARANCE. SOLDER MUST MAINTAIN CABLE STRANDS WITHIN THE MAX DIA. TOLERANCE.
2. USE #6/A6 TIN/LEAD SOLDER ONLY.
3. NOT AVAILABLE IN 28 POSITIONS AND UP.

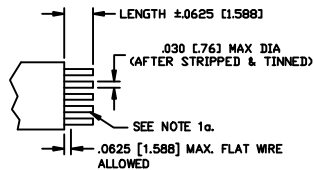

-B"XX"
BREAKOUT OPTION

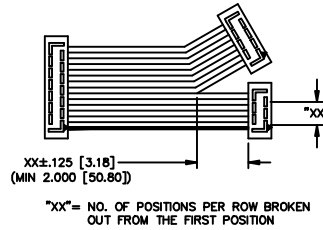

-P"XX"
POLARIZED MATING

XX = POSITION NO.
INSERT POLARIZING KEY PART NO. PK-06-N INTO SPECIFIED POSITION -XX

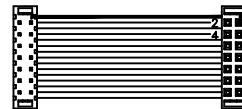

NOTE:
OPTION ONLY AVAILABLE ON FEMALE END OF THE -T (TRANSFER END) OPTION.
THE POLARIZED POSITION WILL HAVE THE SAME ELECTRICAL POSITION FROM THE BROWN WIRE FIRST POSITION INDICATOR.

DRAWING SIZE IN INCHES	UNLESS OTHERWISE NOTED	TOLERANCES ARE	TITLE	DWG NO:
ONE PLACE DECIMALS ± .1	THREE PLACE DECIMALS ± .005	ANGLES ± 1°	.100 C.L. MOLD TO POS. DOUBLE ROW, MALE ASSEMBLY	HCMD-XX-X-XX-XX-XX-XXX-XXX
TWO PLACE DECIMALS ± .01	FOUR PLACE DECIMALS ± .0020			

HCMD-XX-X-XX-XX-XX-XXX-XXX

NO. OF POSITIONS PER ROW
02, 03, 04, 05, 07, 08,
09, 10, 13, 14, 15, 17,
20, 25, 30, 32, 36
(STANDARD COLOR-CODED
CABLE N/A FOR 32 AND 36
POSITIONS. SEE -G OPTION.)

END ASSEMBLY
-S: SINGLE END
-D: DOUBLE END
-T: TRANSFER END

ASSEMBLED LENGTH:
(2 INCH MINIMUM)

OPTION #2
(SEE OPTIONS BELOW AND SHT 2)

OPTION #1
(SEE OPTIONS BELOW AND SHT 2)

LEAD STYLE
-01: (SEE TABLE 1)
-02: (SEE TABLE 1)

PLATING

-T = .00150 BRIGHT ACID TIN ON ENTIRE CONTACT. (USED ONLY WITH FEMALE STRIP OF A -T END OPTION)
-S = .00010 Au. ON TAIL AREA WITH THE BALANCE OF .00150 BRIGHT ACID TIN - USE HCMD-XX-XX-S. (NOT TO BE USED WITH FEMALE STRIP OF A -T END OPTION.)
(STANDARD PLATING IS .00150 BRIGHT ACID TIN OVER ENTIRE TERMINAL - USE HCMD-XX-XX-T. FOR A -T OPTION, STANDARD PLATING FOR THE FEMALE END IS .00150 BRIGHT ACID TIN, EXCEPT CONTACT AREA IS .00010 Au. - USE HCSD-XX-01-SK.)

-N
NOTCH POLARIZATION

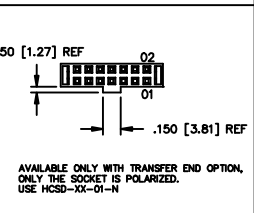

TABLE 1

LEAD STYLE	"A"	1	2	3 (-T END ONLY)
-01	.120 [3.05]	HCMD-XX-01-X	CB-XX-28-7/36-050-C	HCSD-XX-01-X
-02	.230 [5.84]	HCMD-XX-02-X	CB-XX-28-7/36-050-C	HCSD-XX-01-X

SPECIFY NO. OF POS. IN PART CALLOUT -XX

- NOTES:
- IF OPTION IS SPECIFIED WITH -T END ASSEMBLY, SUB-ASSEMBLIES B & C WILL BE HCSD-XX-01-X
 - IF OPTION IS SPECIFIED WITH -T END ASSEMBLY, SUB-ASSEMBLIES B & C WILL BE HCSS-XX-01-X
 - HIDDEN LINES ARE USED TO SHOW POLARIZATION WHEN USING -T-N OPTION
 - Ⓢ REPRESENTS CRITICAL DIMENSIONS FOR STATISTICAL PROCESS CONTROL
 - ALL ASSEMBLIES TO BE 100% ELECTRICALLY TESTED FOR SHORTS AND OPENS.
 - ALL ASSEMBLIES TO BE 100% HI-POT TESTED AT 1000V.
 - WIRE: 28 AWG, 7/36, STRANDED. TINNED WITH PVC INSULATOR.

samtec EPCABLE HCMD-ASM
810 PROGRESS BLVD., NEW ALBANY, INDIANA 47150
PHONE (812) 944-8733 P.O. BOX 1147
CODE 50322
MADE BY: KOLB 8-3-90
HCMD-XX-X-XX-XX-XX-XXX-XXX
SHEET 1 OF 2

REV. T -D"XX"
DAISY CHAIN-DOUBLE (SEE NOTE 1.)

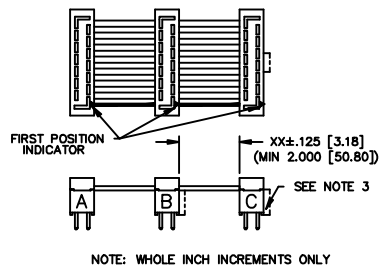

-R
REVERSED CONNECTOR (SEE NOTE 1.)

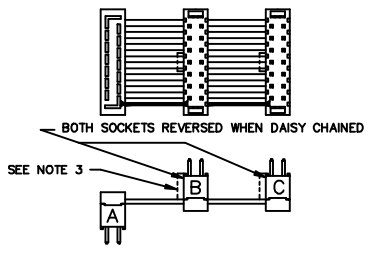

DIMENSIONS ARE IN INCHES		UNLESS OTHERWISE NOTED		TOLERANCES ARE:	
ONE PLACE DECIMALS ± .1	TWO PLACE DECIMALS ± .01	THREE PLACE DECIMALS ± .005	FOUR PLACE DECIMALS ± .0020	ANGLES	± 1'

TITLE: 100 C.L. MOLD TO POS.
DOUBLE ROW, MALE
ASSEMBLY
DWG NO: HMD-XX-X-XX-XX-XX-XX
SHEET 2 of 2

-W"XX"
WIRING REVERSED (SEE NOTE 2.)

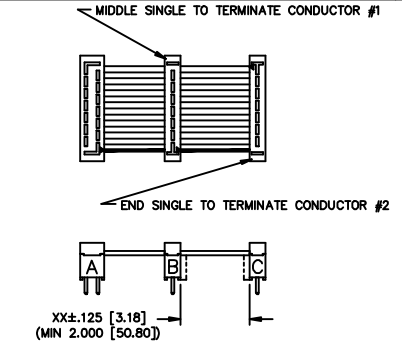

-S"XX"
DAISY CHAIN-SINGLE (SEE NOTE 2.)

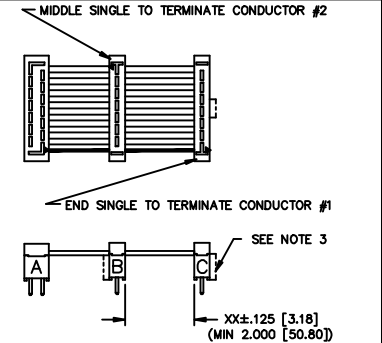

-W"XX"-M
MIDDLE REVERSED

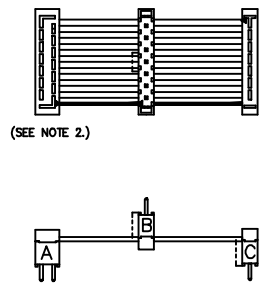

-S"XX"-M
MIDDLE REVERSED

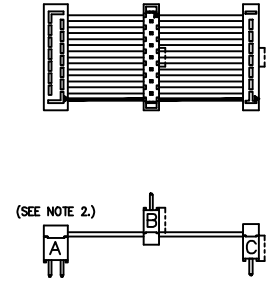

-D"XX"-O
MIDDLE REVERSED (SEE NOTE 1.)

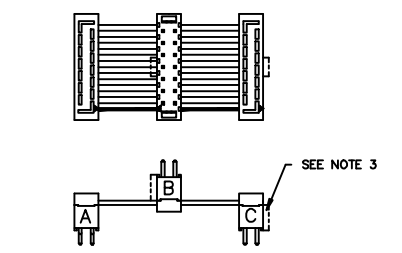

-D"XX"-O
OUTSIDE REVERSED (SEE NOTE 1.)

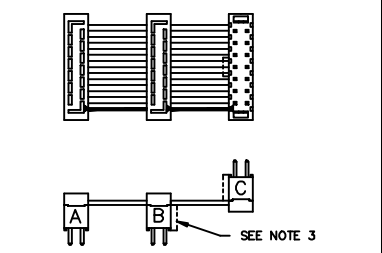

-W"XX"-O
OUTSIDE REVERSED

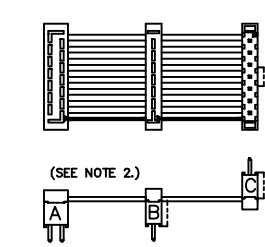

-D"XX"-O
OUTSIDE REVERSED

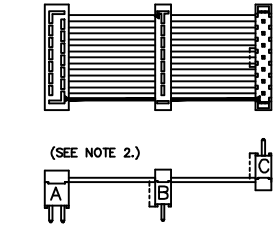

MADE BY: KOLB 8-3-90

520 PARK EAST BLVD. NEW ALBANY, INDIANA 47150
PHONE (812) 844-8733 P.O. BOX 1147
CODE 56322

HMD-XX-X-XX-XX-XX-XX
SHEET 2 of 2