



# AP1122

## 1A Low Dropout Positive Regulator

### ■ Features

- 1.3V maximum dropout at full load current
- Fixed 1.2V± 2% output voltage
- Fast transient response
- Output current limiting
- Built-in thermal shutdown
- Good noise rejection
- **Pb-Free** Packages: SOT223, TO263, TO252, TO220, SOT89

### ■ Applications

- PC peripheral
- Communication

### ■ General Description

AP1122 is a low dropout positive fixed-mode regulator with minimum of 1A output current capability. The product is specifically designed to provide well-regulated supply for low voltage IC applications such as high-speed bus termination and low current 1.2V logic supply. AP1122 is also well suited for other applications such as VGA cards. AP1122 is guaranteed to have lower than 1.3V dropout at full load current making it ideal to provide well-regulated outputs of 1.2 output voltage with 2.5V input voltage supply.

### ■ Ordering Information

Datasheet Directory

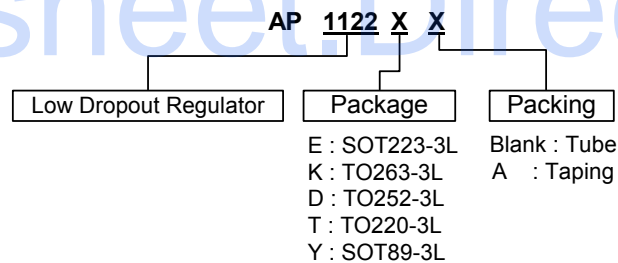

### ■ Typical Circuit

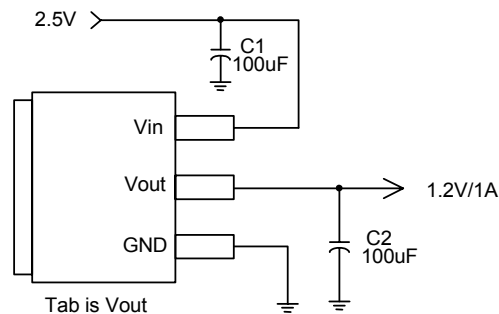



# AP1122

## 1A Low Dropout Positive Regulator

### ■ Connection Diagram

3 PIN SOT223

( Top View )

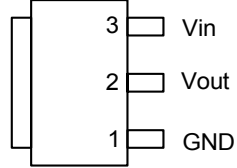

Tab is Vout

3 PIN TO252 / TO263

( Top View )

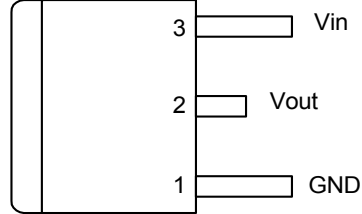

Tab is Vout

3 PIN SOT89

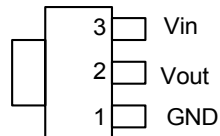

Tab is Vout

3 PIN TO220

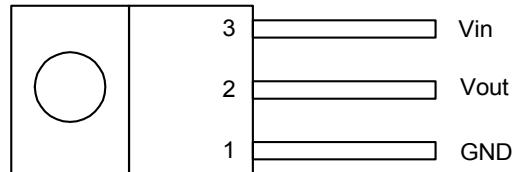

Tab is Vout

### ■ Block Diagram

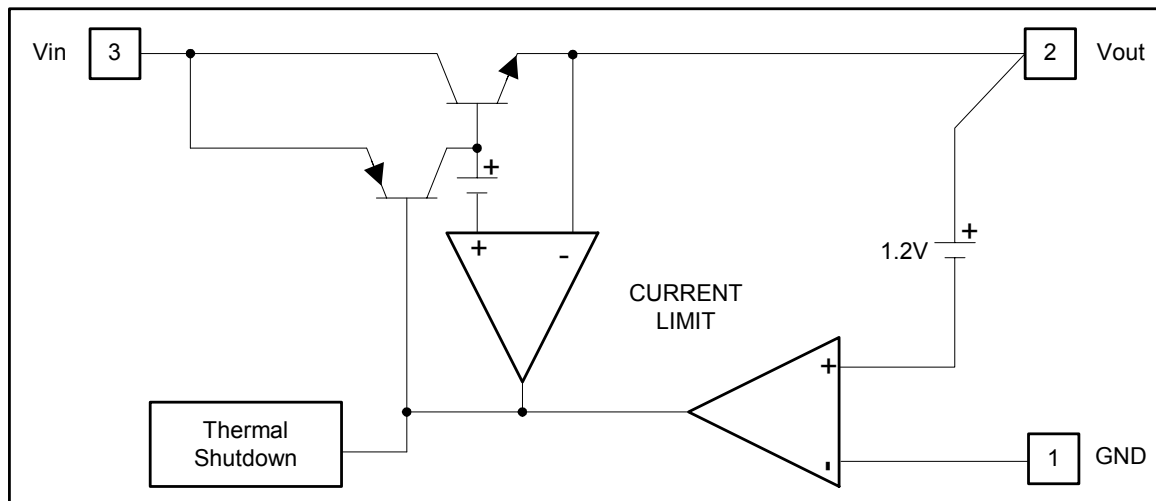



**1A Low Dropout Positive Regulator**

■ **Pin Descriptions**

NAME	I/O	PIN #	FUNCTION
GND	I	1	Ground Pin
Vout	O	2	The output of the regulator. A minimum of 10uF capacitor ( $0.15\Omega \leq \text{ESR} \leq 20\Omega$ ) must be connected from this pin to ground to insure stability.
Vin	I	3	The input pin of regulator. Typically a large storage capacitor ( $0.15\Omega \leq \text{ESR} \leq 20\Omega$ ) is connected from this pin to ground to insure that the input voltage does not sag below the minimum dropout voltage during the load transient response. This pin must always be 1.3V higher than Vout in order for the device to regulate properly.

■ **Absolute Maximum Ratings**

Symbol	Parameter	Rating	Unit
V <sub>in</sub>	DC Supply Voltage	-0.3 to 12	V
P <sub>D</sub>	Power Dissipation	Internally Limited	
T <sub>ST</sub>	Storage Temperature	-65 to +150	°C
T <sub>OP</sub>	Operating Junction Temperature Range	0 to +150	°C

■ **Electrical Characteristics** (Under Operating Conditions)

PARAMETER	CONDITIONS	MIN	TYP	MAX	UNIT
Output Voltage	$2.5V \leq V_{IN} \leq 12V, T_J=25^\circ C$	1.176	1.2	1.224	V
Line Regulation	$I_O=10mA, 2.5V < V_{IN} < 12V, T_J=25^\circ C$			0.2	%
Load Regulation	$V_{IN}=2.5V \sim 12V, V_{adj}=0.0mA < I_O < 1A, T_J=25^\circ C$ (Note 1,2)			1	%
Dropout Voltage (V <sub>IN</sub> -V <sub>OUT</sub> )	$I_{OUT} = 1A, \Delta V_{OUT}=0.1\% V_{OUT}$		1.3	1.4	V
Current Limit	$(V_{IN}-V_{OUT}) = 5V$	1.1			A
Minimum Load Current	$0^\circ C \leq T_J \leq 125^\circ C$		5	10	mA
Thermal Regulation	$T_A=25^\circ C, 30ms$ pulse		0.008	0.04	%/W
Ripple Rejection	$F=120Hz, C_{OUT}=25\mu F$ Tantalum, $I_{OUT}=1A,$ $V_{IN}=V_{OUT}+3V$		60	70	dB
Temperature Stability	$I_O=10mA$		0.5		%
$\theta_{JA}$ Thermal Resistance Junction- to-Ambient (No heat sink ;No air flow)	SOT89 SOT-223 TO-252 TO-220/263		300 117 92 85		°C/W
$\theta_{JC}$ Thermal Resistance Junction-to-Case	SOT89 : Control Circuitry/Power Transistor SOT-223 : Control Circuitry/Power Transistor TO-263 : Control Circuitry/Power Transistor TO-252 : Control Circuitry/Power Transistor TO-220 : Control Circuitry/Power Transistor		100 15 0.65/2.7 10 0.65/2.7		°C/W

**Note1:** See thermal regulation specifications for changes in output voltage due to heating effects. Line and load regulation are measured at a constant junction temperature by low duty cycle pulse testing. Load regulation is measured at the output lead = 1/18" from the package.

**Note2:** Line and load regulation are guaranteed up to the maximum power dissipation of 15W. Power dissipation is determined by the difference between input and output differential and the output current. Guaranteed maximum power dissipation will not be available over the full input/output range.

**Note3:** Quiescent current is defined as the minimum output current required in maintaining regulation. At 12V input/output differential the device is guaranteed to regulate if the output current is greater than 10mA.



**1A Low Dropout Positive Regulator**

■ **Typical Performance Characteristics**

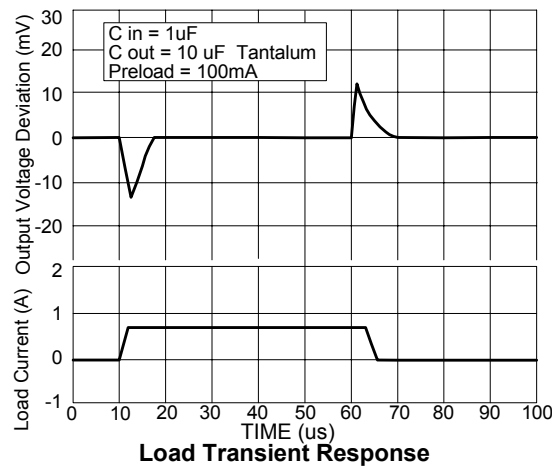
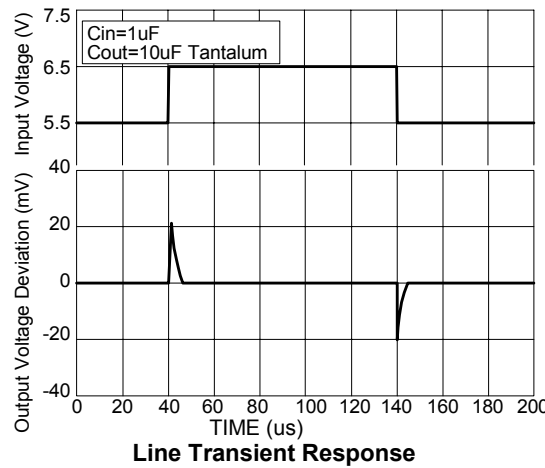
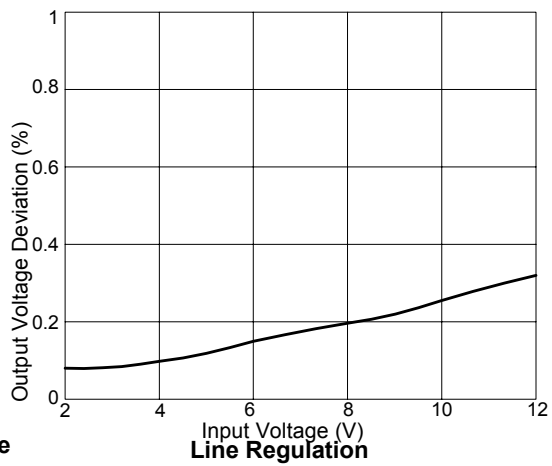
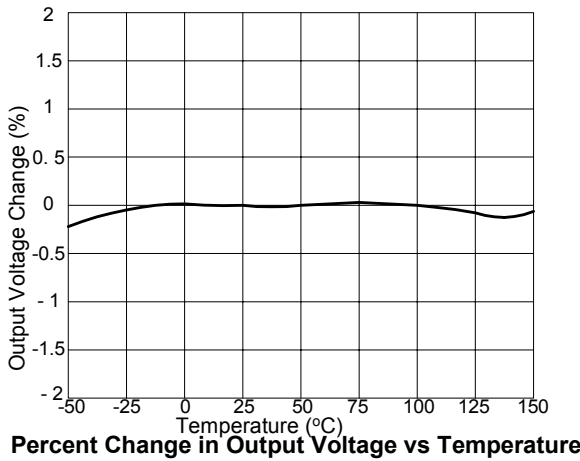
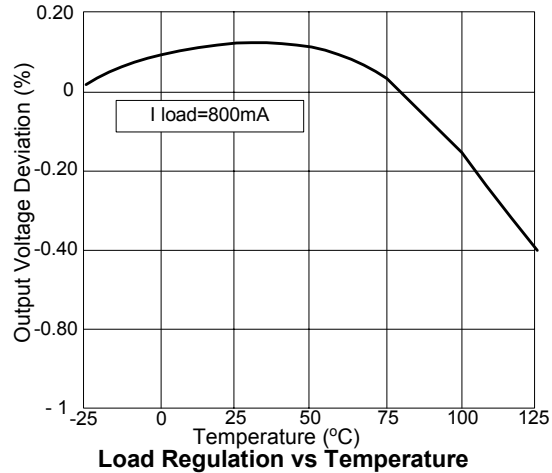
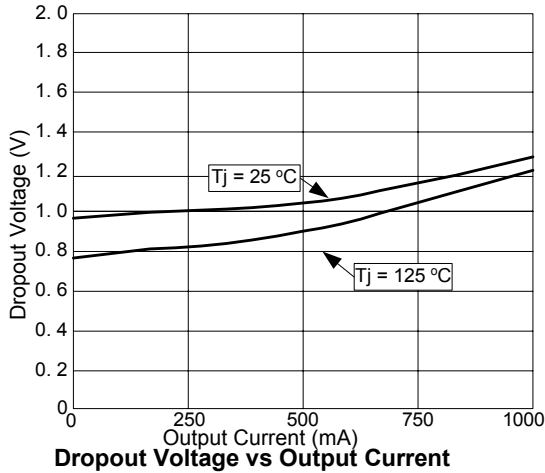



# AP1122

## 1A Low Dropout Positive Regulator

### ■ Marking Information

(1) SOT223-3L

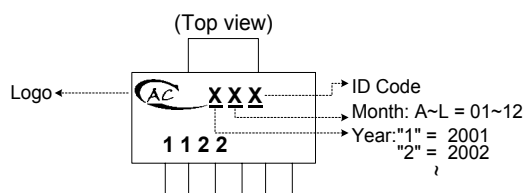

(2) TO252-3L

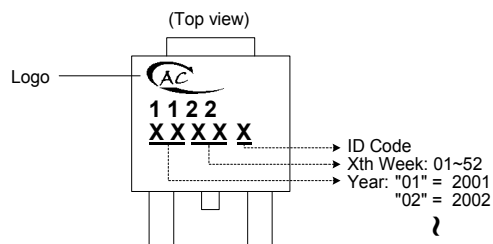

(3) TO220-3L

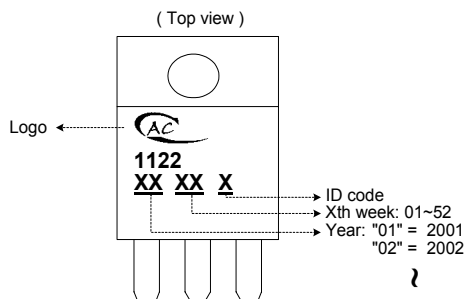

(4) SOT89-3L

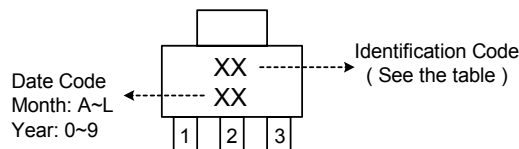

Identification code	Output version
JB	AP1122

(5) TO263-3L

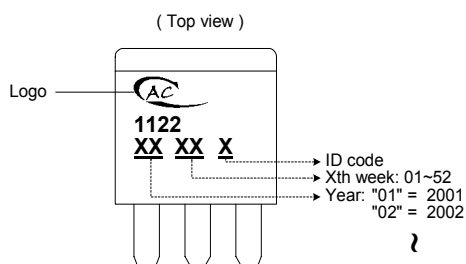



**AP1122**

**1A Low Dropout Positive Regulator**

■ **Package Dimension**

(1) SOT223

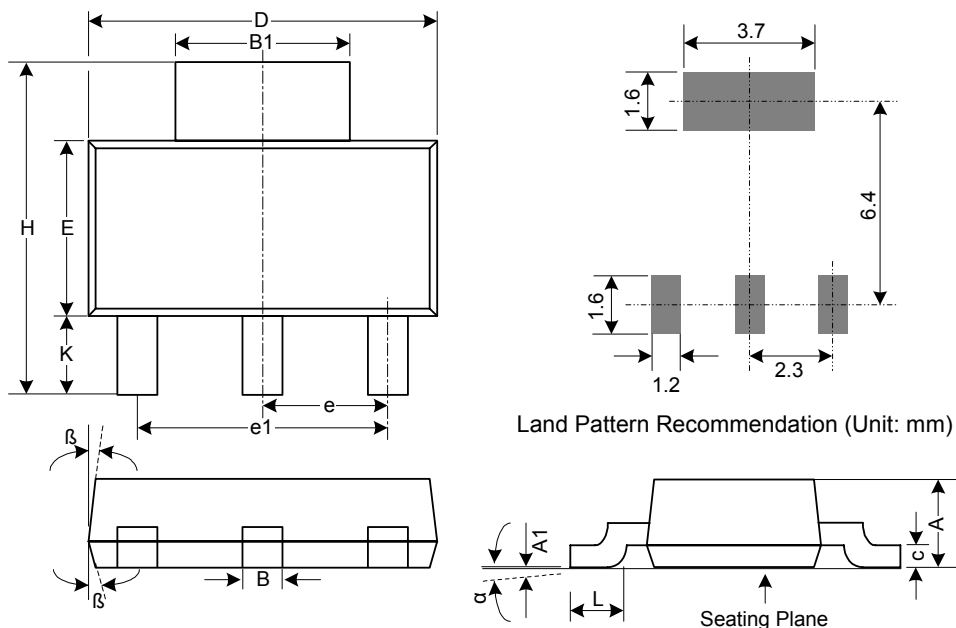

Symbol	Dimensions In Millimeters			Dimensions In Inches		
	Min.	Nom.	Max.	Min.	Nom.	Max.
A	1.50	1.65	1.80	0.059	0.065	0.071
A1	0.02	0.05	0.08	0.001	0.002	0.003
B	0.60	0.70	0.80	0.024	0.028	0.031
B1	2.80	-	3.40	0.110	-	0.134
c	0.28	0.30	0.32	0.011	0.012	0.013
D	6.30	6.50	6.70	0.248	0.256	0.264
E	3.30	3.50	3.70	0.130	0.138	0.146
e	2.3 Basic			0.091 Basic		
e1	4.6 Basic			0.181 Basic		
H	6.70	7.00	7.30	0.264	0.276	0.287
L	0.91	1.00	1.10	0.036	0.039	0.043
K	1.50	1.75	2.00	0.059	0.069	0.079
$\alpha$	0°	5°	10°	0°	5°	10°
$\beta$	-	13°	-	-	13°	-



**1A Low Dropout Positive Regulator**

(2) TO263

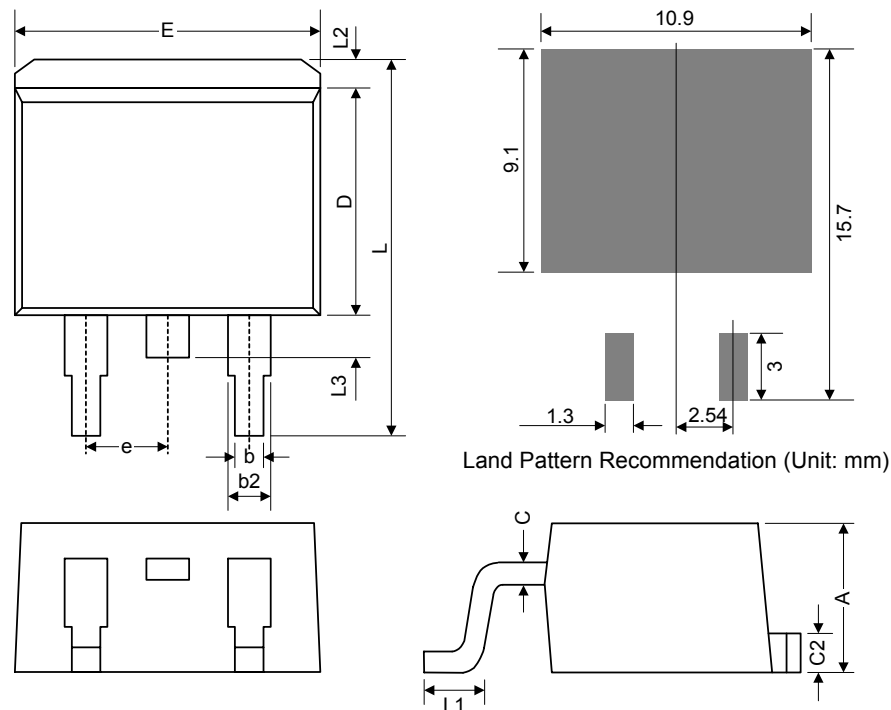

Symbol	Dimensions In Millimeters			Dimensions In Inches		
	Min.	Nom.	Max.	Min.	Nom.	Max.
A	4.06	4.45	4.83	0.160	0.175	0.190
b	0.51	0.75	0.99	0.020	0.030	0.039
b2	1.14	1.27	1.40	0.045	0.050	0.055
C	0.38 TYP.			0.015 TYP.		
C2	1.14	1.27	1.40	0.045	0.050	0.055
D	8.65	9.15	9.65	0.341	0.360	0.380
E	9.65	9.97	10.29	0.380	0.393	0.405
e	2.54 BSC.			0.100 BSC.		
L	14.61	15.24	15.88	0.575	0.600	0.625
L1	2.28	2.54	2.80	0.090	0.100	0.110
L2	-	1.30	2.92	-	0.051	0.115
L3	1.27	1.52	1.78	0.050	0.060	0.070



**AP1122**

**1A Low Dropout Positive Regulator**

(3) TO252

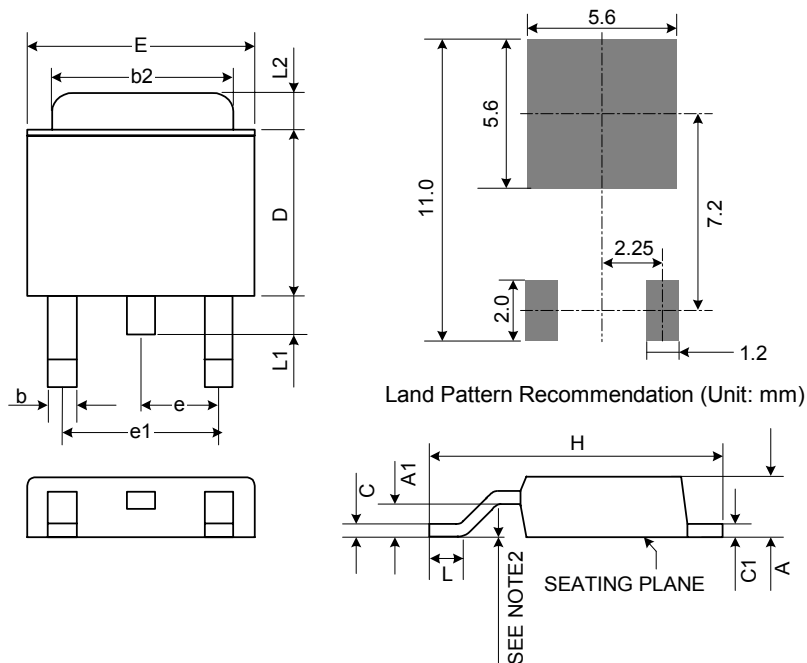

Notes:

1. JEDEC Outline: TO-252 AB
2. Mils suggested for positive contact at mounting.

Symbol	Dimensions In Millimeters			Dimensions In Inches		
	Min.	Nom.	Max.	Min.	Nom.	Max.
A	2.18	2.29	2.40	0.086	0.090	0.094
A1	0.89	-	1.14	0.035	-	0.045
b	0.61 TYP.			0.024 TYP.		
b2	5.20	5.35	5.50	0.205	0.211	0.217
C	0.45	0.52	0.58	0.018	0.020	0.023
C1	0.45	0.52	0.58	0.018	0.020	0.023
D	5.40	5.57	6.20	0.213	0.219	0.244
E	6.35	6.58	6.80	0.250	0.259	0.268
e	2.28 BSC.			0.090 BSC.		
e1	4.57 BSC.			0.180 BSC.		
H	9.00	9.70	10.40	0.354	0.382	0.409
L	0.51	-	-	0.020	-	-
L1	0.64	0.83	1.02	0.025	0.033	0.040
L2	0.88	-	1.27	0.035	-	0.050





**AP1122**

**1A Low Dropout Positive Regulator**

(4) TO220

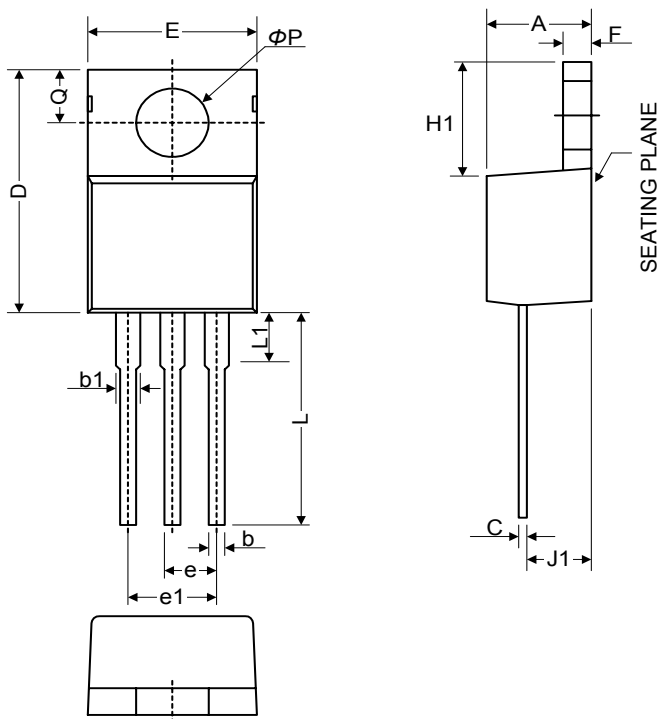

Symbol	Dimensions In Millimeters			Dimensions In Inches		
	Min.	Nom.	Max.	Min.	Nom.	Max.
A	3.55	4.20	4.85	0.140	0.165	0.191
b1	1.14	1.46	1.78	0.045	0.057	0.070
b	0.51	0.83	1.14	0.020	0.033	0.045
C	0.31	0.72	1.14	0.012	0.028	0.045
D	14.20	15.35	16.50	0.559	0.604	0.650
E	9.70	10.20	10.70	0.382	0.402	0.421
e	2.29	2.54	2.79	0.090	0.100	0.110
e1	4.83	5.08	5.33	0.190	0.200	0.210
F	0.51	0.95	1.40	0.020	0.037	0.055
H1	5.84	6.35	6.86	0.230	0.250	0.270
J1	2.03	2.48	2.92	0.080	0.098	0.115
L	12.72	13.72	14.72	0.501	0.540	0.580
L1	3.66	5.00	6.35	0.144	0.197	0.250
øP	3.53	3.81	4.09	0.139	0.150	0.161
Q	2.54	2.98	3.43	0.100	0.117	0.135



**AP1122**

**1A Low Dropout Positive Regulator**

(5) SOT89

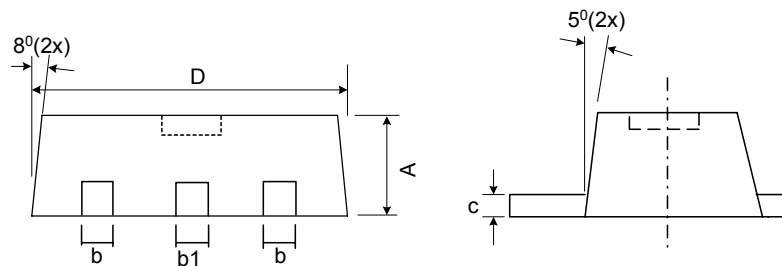
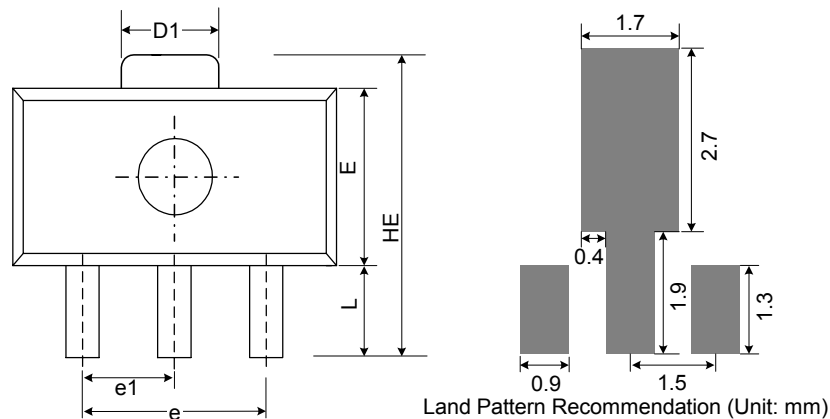

Symbol	Dimensions In Millimeters			Dimensions In Inches		
	Min.	Nom.	Max.	Min.	Nom.	Max.
A	1.40	1.50	1.60	0.055	0.059	0.063
b	0.36	0.42	0.48	0.014	0.016	0.018
b1	0.41	0.47	0.53	0.016	0.043	0.051
C	0.35	0.39	0.43	0.014	0.015	0.017
D	4.40	4.50	4.60	0.173	0.177	0.181
D1	1.40	1.60	1.75	0.055	0.062	0.069
e	2.90	3.00	3.10	0.114	0.118	0.122
e1	1.45	1.50	1.55	0.057	0.059	0.061
E	2.35	2.48	2.60	0.093	0.098	0.102
HE	3.94	-	4.25	0.155	-	0.167
L	0.80	-	1.20	0.031	-	0.047