

Major Ratings and Characteristics

Characteristics	STPS1L30U	Units
$I_{F(AV)}$ Rectangular waveform	1.0	A
V_{RRM}	30	V
I_{FSM} @ $t_p = 5\text{ms}$ sine	360	A
V_F @ $1.0\text{Apk}, T_j = 125^\circ\text{C}$	0.30	V
T_j range	-55 to 150	$^\circ\text{C}$

Description/Features

The STPS1L30U surface-mount Schottky rectifier has been designed for applications requiring low forward drop and small foot prints on PC boards. Typical applications are in disk drives, switching power supplies, converters, free-wheeling diodes, battery charging, and reverse battery protection.

- Small foot print, surface mountable
- Very low forward voltage drop
- High frequency operation
- Guard ring for enhanced ruggedness and long term reliability

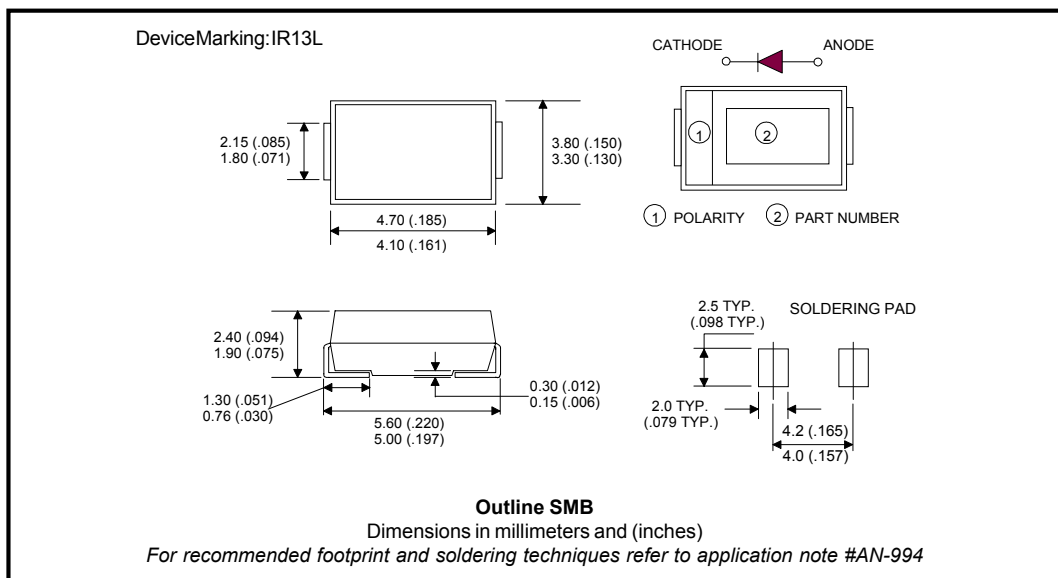
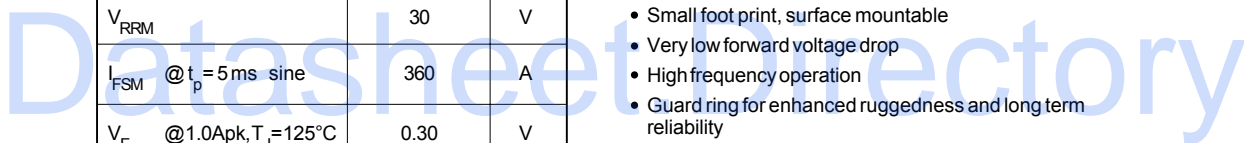

Voltage Ratings

Part number	STPS1L30U
V_R Max. DC Reverse Voltage (V)	30
V_{RWM} Max. Working Peak Reverse Voltage (V)	

Absolute Maximum Ratings

Parameters	Value	Units	Conditions
$I_{F(AV)}$ Max. Average Forward Current	1.0	A	50% duty cycle @ $T_L = 106^\circ\text{C}$, rectangular wave form
I_{FSM} Max. Peak One Cycle Non-Repetitive Surge Current	360	A	5 μs Sine or 3 μs Rect. pulse
	75		10ms Sine or 6ms Rect. pulse
E_{AS} Non Repetitive Avalanche Energy	9	mJ	$T_J = 25^\circ\text{C}$, $I_{AS} = 0.2\text{A}$, $L = 13\text{mH}$

Electrical Specifications

Parameters	Value	Units	Conditions
V_{FM} Max. Forward Voltage Drop (1)	0.420	V	@ 1A
	0.470	V	@ 2A
	0.300	V	@ 1A
	0.375	V	@ 2A
I_{RM} Max. Reverse Leakage Current (1)	0.2	mA	$T_J = 25^\circ\text{C}$
	5.0	mA	$T_J = 100^\circ\text{C}$
	15	mA	$T_J = 125^\circ\text{C}$
C_T Max. Junction Capacitance	200	pF	$V_R = 5V_{DC}$, (test signal range 100KHz to 1Mhz) 25°C
L_S Typical Series Inductance	2.0	nH	Measured lead to lead 5mm from package body
dv/dt Max. Voltage Rate of Change (Rated V_R)	10000	V/ μs	

(1) Pulse Width < 300 μs , Duty Cycle < 2%

Thermal-Mechanical Specifications

Parameters	Value	Units	Conditions
T_J Max. Junction Temperature Range	-55 to 150	$^\circ\text{C}$	
T_{stg} Max. Storage Temperature Range	-55 to 150	$^\circ\text{C}$	
R_{thJL} Max. Thermal Resistance Junction to Lead (2)	25	$^\circ\text{C}/\text{W}$	
wt Approximate Weight	0.10	g	
Case Style	SMB		Similar DO-214AA

(2) Mounted 1 inch square PCB, Thermal Probe connected to lead 2mm from Package

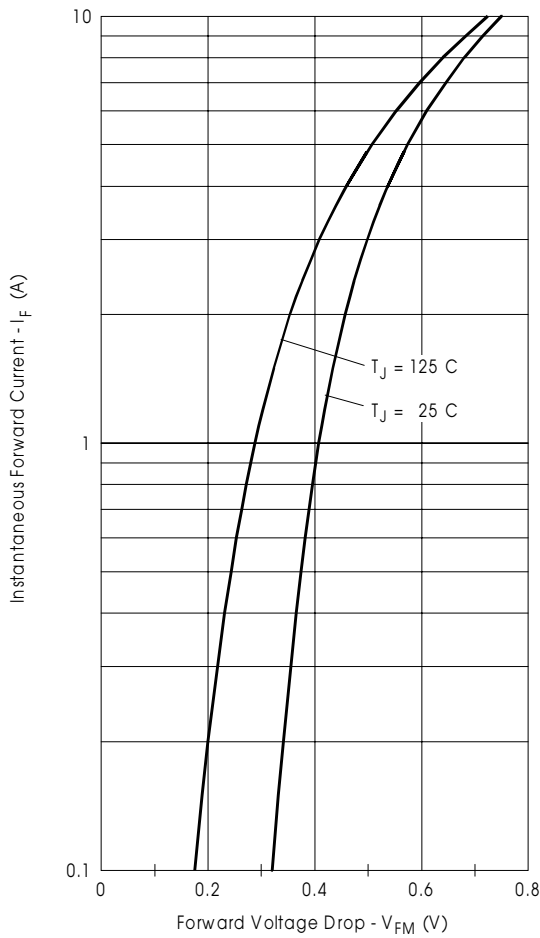

Fig. 1 - Maximum Forward Voltage Drop Characteristics

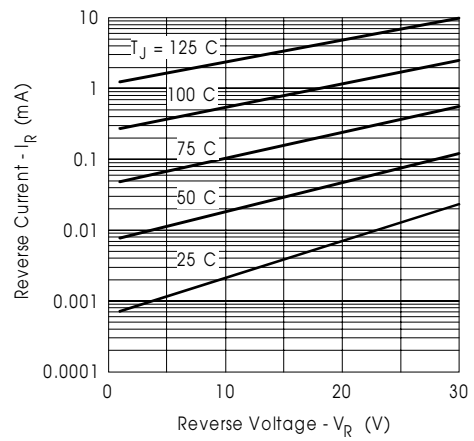

Fig. 2 - Typical Peak Reverse Current Vs. Reverse Voltage

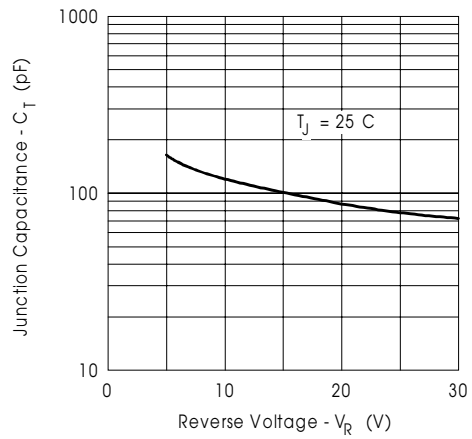

Fig. 3 - Typical Junction Capacitance Vs. Reverse Voltage

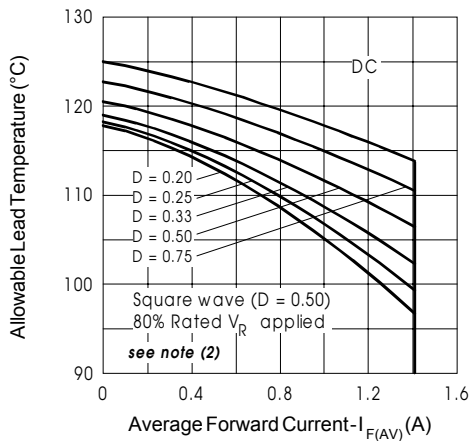

Fig. 4- Maximum Average Forward Current Vs. Allowable Lead Temperature

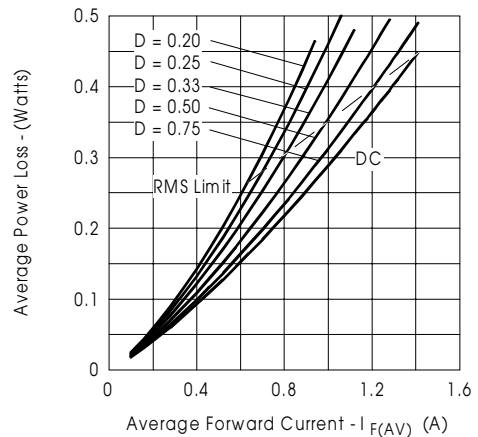

Fig. 5- Maximum Average Forward Dissipation Vs. Average Forward Current

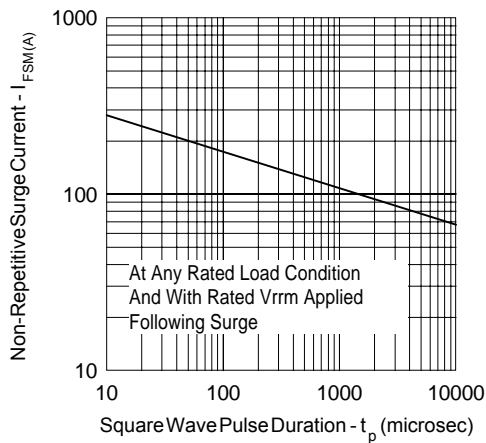

Fig. 6- Maximum Peak Surge Forward Current Vs. Pulse Duration

(2) Formula used: $T_C = T_J - (Pd + Pd_{REV}) \times R_{thJC}$;

Pd = Forward Power Loss = $I_{F(AV)} \times V_{FM} @ (I_{F(AV)} / D)$ (see Fig. 6);

Pd_{REV} = Inverse Power Loss = $V_{R1} \times I_R (1 - D)$; $I_R @ V_{R1} = 80\%$ rated V_R

Tape & Reel Information

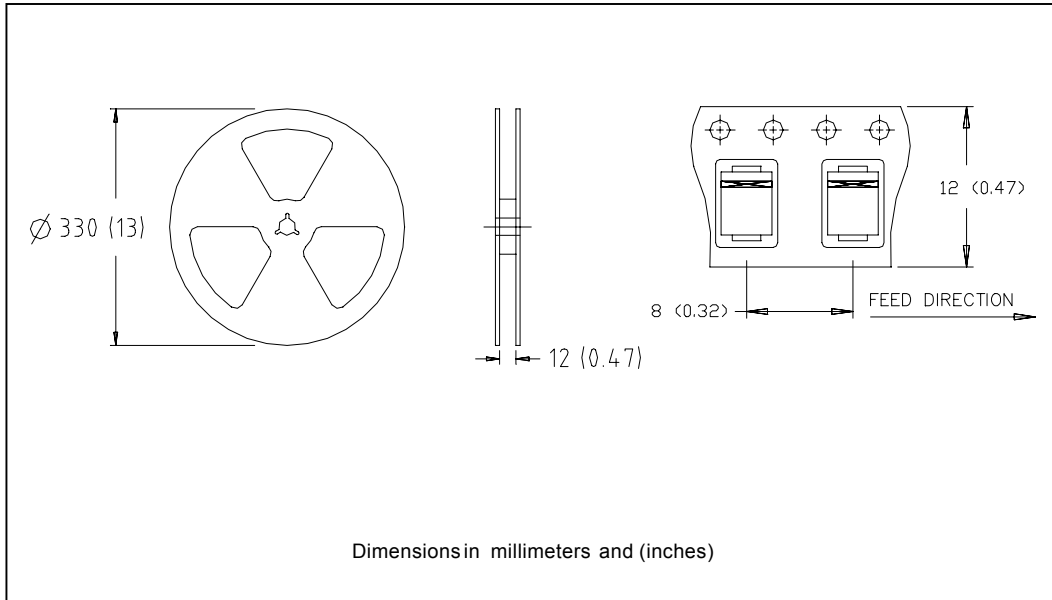

Marking & Identification

Each device has marking and identification on two rows.
 - The first row designates the device as manufactured by International Rectifier as indicated by the letters "IR", then the package label i.e. "G", Current and Voltage.
 - The second row shows the data code: Year and Week.

See below marking diagram.

FIRST ROW

IR 13 L

SECOND ROW

Date Code

YY WW

Ordering Information

STPS1L30U - TAPE AND REEL

WHEN ORDERING, INDICATE THE PART NUMBER AND THE QUANTITY (IN MULTIPLES OF 3000 PIECES).

EXAMPLE: STPS1L30U - 6000 PIECES

STPS1L30U

Bulletin PD-20583 04/01

International
IOR Rectifier

Data and specifications subject to change without notice.
This product has been designed and qualified for Industrial Level.
Qualification Standards can be found on IR's Web site.

International
IOR Rectifier

IR WORLD HEADQUARTERS: 233 Kansas St., El Segundo, California 90245, USA Tel: (310) 252-7105
TAC Fax: (310) 252-7309
Visit us at www.irf.com for sales contact information. 04/01