

### Features

- Planar Die Construction
- Ultra-Small Surface Mount Package
- General Purpose
- Ideally suited for Automated Assembly Processes
- Also Available in Lead Free Version

### Mechanical Data

- Case: SOD-323, Plastic
- Case Material - UL Flammability Classification Rating 94V-0
- Moisture Sensitivity: Level 1 per J-STD-020A
- Terminals: Solderable per MIL-STD-202, Method 208
- Also Available in Lead Free Plating (Matte Tin Finish). Please see Ordering Information, Note 4, on Page 2
- Polarity: Cathode Band
- Marking: See Page 2
- Weight: 0.004 grams (approx.)

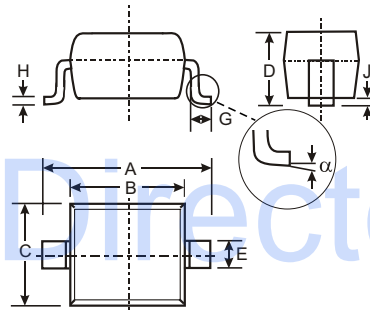

SOD-323		
Dim	Min	Max
A	2.30	2.70
B	1.60	1.80
C	1.20	1.40
D	1.05 Typical	
E	0.25	0.35
G	0.20	0.40
H	0.10	0.15
J	0.05 Typical	
$\alpha$	0°	8°
All Dimensions in mm		

### Maximum Ratings @ $T_A = 25^\circ\text{C}$ unless otherwise specified

Characteristic	Symbol	Value	Unit
Forward Voltage (Note 2) @ $I_F = 10\text{mA}$	$V_F$	0.9	V
Power Dissipation (Note 1)	$P_d$	200	mW
Thermal Resistance, Junction to Ambient Air (Note 1)	$R_{\theta JA}$	625	$^\circ\text{C/W}$
Operating and Storage Temperature Range	$T_J, T_{STG}$	-65 to +150	$^\circ\text{C}$

- Notes:
1. Part mounted on FR-4 PC board with recommended pad layout, which can be found on our website at <http://www.diodes.com/datasheets/ap02001.pdf>.
  2. Short duration pulse test used to minimize self-heating effect.

## Electrical Characteristics @ T<sub>A</sub> = 25°C unless otherwise specified

Type Number	Marking Code	Zener Voltage Range (Note 1)			Test Current	Maximum Zener Impedance (Note 2)		Maximum Reverse Leakage Current (Note 1)	
		V <sub>Z</sub> @ I <sub>ZT</sub>				I <sub>ZT</sub>	Z <sub>ZT</sub> @ I <sub>ZT</sub>	Z <sub>ZK</sub> @ I <sub>ZK</sub> = 0.25mA	I <sub>R</sub>
		Nom (V)	Min (V)	Max (V)	mA	Ω		μA	V
MMSZ5221BS	C1	2.4	2.28	2.52	20	30	1200	100	1.0
MMSZ5223BS	C3	2.7	2.57	2.84	20	30	1300	75	1.0
MMSZ5225BS	C5	3.0	2.85	3.15	20	30	1600	50	1.0
MMSZ5226BS	G1	3.3	3.14	3.47	20	28	1600	25	1.0
MMSZ5227BS	G2	3.6	3.42	3.78	20	24	1700	15	1.0
MMSZ5228BS	G3	3.9	3.71	4.10	20	23	1900	10	1.0
MMSZ5229BS	G4	4.3	4.09	4.52	20	22	2000	5.0	1.0
MMSZ5230BS	G5	4.7	4.47	4.94	20	19	1900	5.0	2.0
MMSZ5231BS	E1	5.1	4.85	5.36	20	17	1600	5.0	2.0
MMSZ5232BS	E2	5.6	5.32	5.88	20	11	1600	5.0	3.0
MMSZ5233BS	E3	6.0	5.70	6.30	20	7	1600	5.0	3.5
MMSZ5234BS	E4	6.2	5.89	6.51	20	7	1000	5.0	4.0
MMSZ5235BS	E5	6.8	6.46	7.14	20	5	750	3.0	5.0
MMSZ5236BS	F1	7.5	7.13	7.88	20	6	500	3.0	6.0
MMSZ5237BS	F2	8.2	7.79	8.61	20	8	500	3.0	6.5
MMSZ5238BS	F3	8.7	8.27	9.14	20	8	600	3.0	6.5
MMSZ5239BS	F4	9.1	8.65	9.56	20	10	600	3.0	7.0
MMSZ5240BS	F5	10	9.50	10.50	20	17	600	3.0	8.0
MMSZ5241BS	H1	11	10.45	11.55	20	22	600	2.0	8.4
MMSZ5242BS	H2	12	11.40	12.60	20	30	600	1.0	9.1
MMSZ5243BS	H3	13	12.35	13.65	9.5	13	600	0.5	9.9
MMSZ5245BS	H5	15	14.25	15.75	8.5	16	600	0.1	11
MMSZ5246BS	J1	16	15.20	16.80	7.8	17	600	0.1	12
MMSZ5248BS	J3	18	17.10	18.90	7.0	21	600	0.1	14
MMSZ5250BS	J5	20	19.00	21.00	6.2	25	600	0.1	15
MMSZ5251BS	K1	22	20.90	23.10	5.6	29	600	0.1	17
MMSZ5252BS	K2	24	22.80	25.20	5.2	33	600	0.1	18
MMSZ5254BS	K4	27	25.65	28.35	5.0	41	600	0.1	21
MMSZ5255BS	K5	28	26.60	29.40	4.5	44	600	0.1	21
MMSZ5256BS	M1	30	28.50	31.50	4.2	49	600	0.1	23
MMSZ5257BS	M2	33	31.35	34.65	3.8	58	700	0.1	25
MMSZ5258BS	M3	36	34.20	37.80	3.4	70	700	0.1	27
MMSZ5259BS	M4	39	37.05	40.95	3.2	80	800	0.1	30

Notes: 1. Short duration test pulse used to minimize self-heating effect.  
2. f = 1KHz.

## Ordering Information (Note 3)

Device	Packaging	Shipping
(Type Number)-7*	SOD-323	3000/Tape & Reel

Notes: 3. For Packaging Details, go to our website at: <http://www.diodes.com/datasheets/ap02007.pdf>.  
\*Add "-7" to the appropriate type number in Table 1 above example: 6.2V Zener = MMSZ5234BS-7.  
4. For Lead Free version (with Lead Free terminal finish) part number, please add "-F" suffix to part number above.  
Example: MMSZ5234BS -7-F.

## Marking Information



XX = Product Type Marking Code  
(See Table Above)

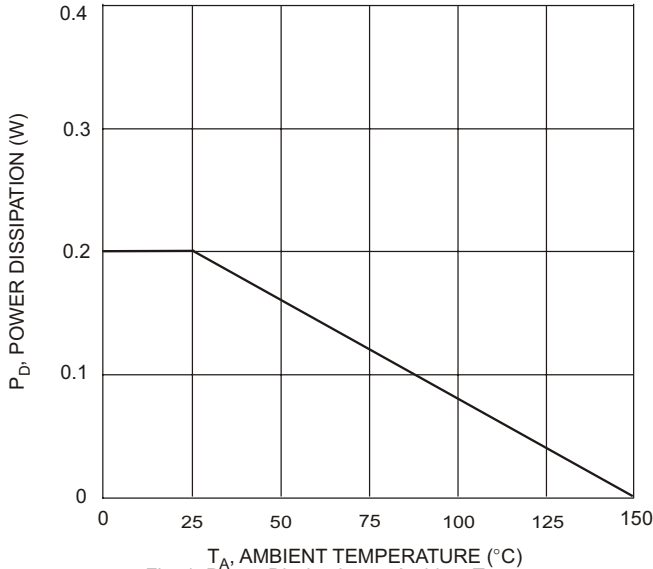

Fig. 1 Power Dissipation vs Ambient Temperature

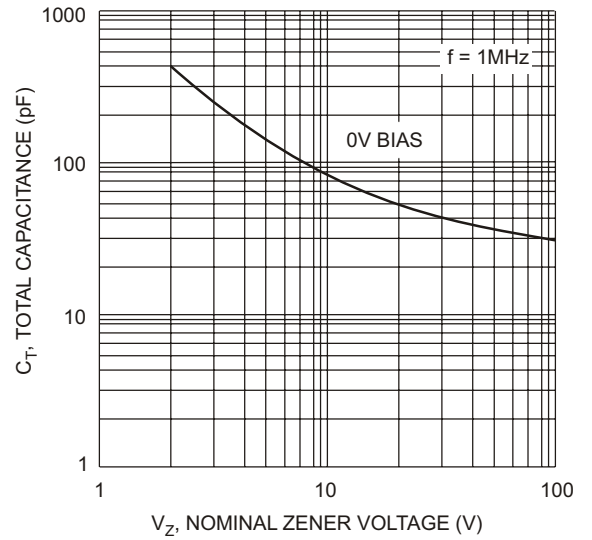

Fig. 2 Typical Capacitance

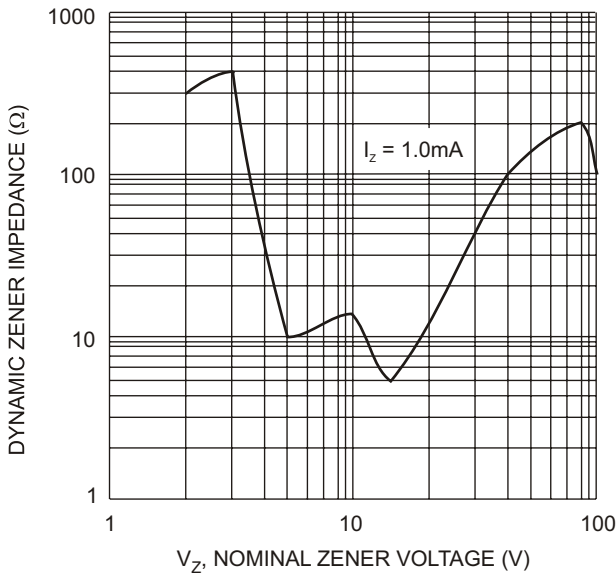

Fig. 3 Zener Impedance vs. Zener Voltage

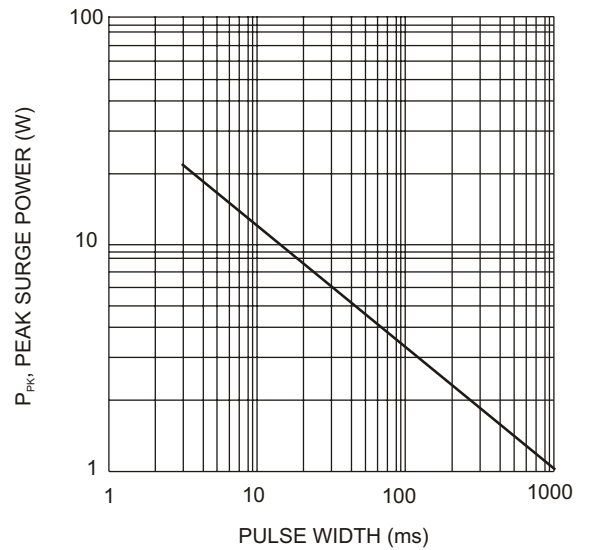

Fig. 4 Maximum Non-repetitive Surge Power

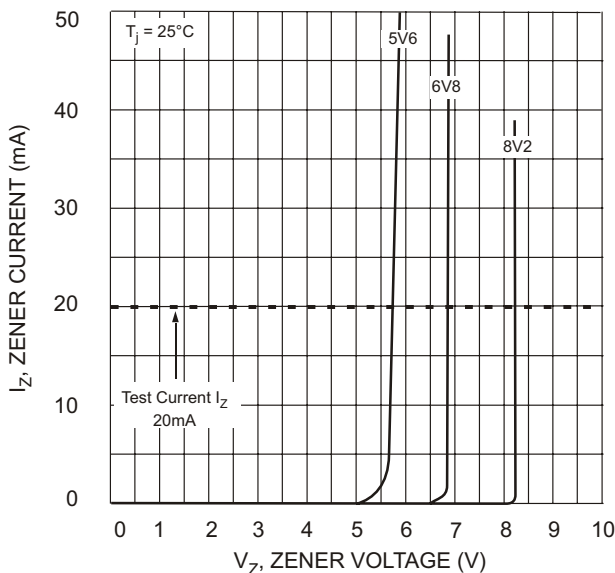

Fig. 5 Zener Breakdown Characteristics

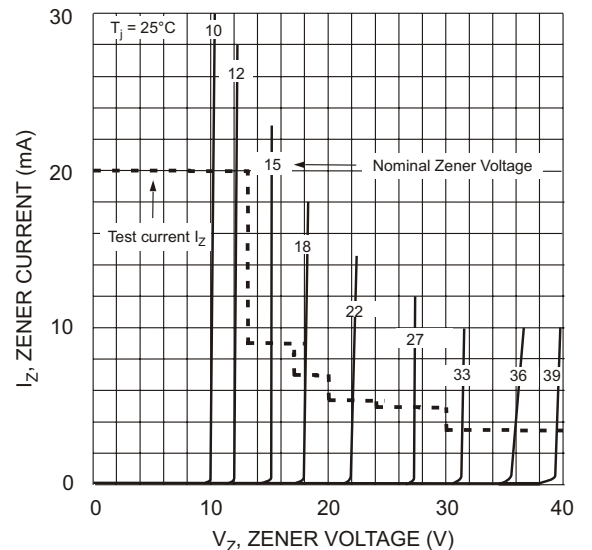

Fig. 6 Zener Breakdown Characteristics