



## Passive components sales offices

### • Head office

206, Cheomdansaneop Road,  
Yeongtong-gu, Suwon-city,  
Gyeonggi province, Korea,  
443-743

Europe  
Tel: +82-31-210-6328  
E-mail: james.pyun@samsung.com

America  
Tel: +82-31-210-6803  
E-mail: wesley.roh@samsung.com

Asia  
Tel: +82-31-210-6791  
E-mail: peter.kim@samsung.com

Domestic  
Tel: +82-31-210-5074  
E-mail: boungho.lee@samsung.com

### • Manufacturing sites

Suwon Plant (Korea)  
206, Cheomdansaneop Road,  
Yeongtong-gu, Suwon-city,  
Gyeonggi province, Korea,  
443-743  
Tel: +82-31-210-5074  
E-mail: boungho.lee@samsung.com

Busan Plant (Korea)  
1623-2, Songjeong-dong,  
Gangseo-gu, Busan, Korea,  
618-270  
Tel: +82-51-970-7671  
E-mail: kyc.kweon@samsung.com

Tianjin Plant (China)  
27, Heiniucheng-Road, Hexi District,  
Tianjin, 300210 China  
Tel: +86-22-2397-9000(310)  
E-mail: moohantop.Park@samsung.com

High Tech (China)  
Xiqind Dist. Micro-Electronics  
Industrial Park, Jingang Highway,  
Tianjin, China 300485  
Tel: +86-22-23979000-313  
E-mail: enhao.song@samsung.com

Binhai Plant (China)  
80, Xiaqing Road, West area of  
BinHai development zone,  
TianJin, 300458, China  
Tel: +86-22-6686-3333(1300)  
E-mail: sk1000.kim@samsung.com

### • Philippines Plant (Philippines)

Block No.5, Calamba Premiere  
International Park, Batino, Calamba,  
Laguna, Manila, Philippines 4027  
Tel: +63-49-545-0422  
E-mail: donna@samsung.com

### • Asia sales offices

Shenzhen Office  
46 F, New World Center,  
Yitian Road, Futian District,  
Shenzhen, 518026 China  
Tel: 86-755-8608-5571  
E-mail: jackson.xian@samsung.com

Shanghai Office  
Rm. 1211, Shanghai International  
Trade Center, No. 2201 Yan an (W) Rd.,  
Shanghai, 200335 China  
Tel: 86-21-6270-4168(274)  
E-mail: dennis.cha@samsung.com

HongKong Office  
8/F., Central Plaza, 18 Harbour Road,  
Wanchai, Hongkong, China  
Tel: 852-28626344  
E-mail: vivianchan@samsung.com

Qingdao Office  
Rm 1201, Growne Plaza Qingdao 76,  
Xiang Gang Zhong Rd, Qingdao,  
266071 China  
Tel: 86-532-85779102  
E-mail: zhengguo.cui@samsung.com

Taiwan Office  
9F-1, Np. 399 Ruey Kuang Rd., Neihu  
District, Taipei City, Taiwan, 114  
Tel: 886-2-2656-8356  
E-mail: kevin0130.wang@samsung.com

Singapore Office  
3 Church Street Samsung Hub,  
#23-02 Singapore 049483  
Tel: 65-6833-3228  
E-mail: winson.yeong@samsung.com

Bangkok Office  
23rd Floor, Lake Rajada Office Complex  
193/89 Rachadapisek Road,  
Khet Klongtoey, Bangkok 10110, Thailand  
Tel: 66-2-661-8004~5  
E-mail: yangshin.yi@samsung.com

### • America sales office

Irvine Office  
3333 Michelson Drive,  
Suite 500, Irvine, CA 92612, USA  
Tel: 1-949-797-8016  
E-mail: andrew.skelly@samsung.com

### • Europe sales offices

Frankfurt Office  
Samsung Haus, Am Kronberger Hang 6,  
D-65824 Schwalbach/Ts. Germany  
Tel: 49-6196-66-7255  
E-mail: frank.goebel@samsung.com

Hungary Office  
H-2310, Leshegy utca 2-4,  
Szigetszentmiklos, Pest megye, Hungary  
Tel: 36-24-551-148  
E-mail: jun21c.lee@samsung.com

### • Domestic Distributors

Korchip Corporation  
817-38, Anyang 2-dong, Manan-gu,  
Anyang-city, Gyeonggi province,  
Korea, 430-812  
Tel: +82-31-361-8100  
E-mail: itasap@korchip.com

SAMT  
Daekyung Bldg., 983-10, Daechi-dong,  
Gangnam-gu, Seoul, Korea  
Tel: +82-2-3458-9000  
E-mail: info@isamt.com

CHUNGMAC  
301 Gwonseon Medivill, 544-14  
Gokbanjeong-dong, Gwonseon-gu,  
Suwon-si, Gyeonggi-do Korea  
Tel: +82-31-234-2367~8  
E-mail: webmaster@chungmac.co.kr

YOUNGDUK  
Gasam-Dong 632, Seobusaetgil,  
Geumcheon-Gu, Seoul, Korea  
Tel: +82-2-2107-7860  
E-mail: siyang1109@gmail.com

# MULTILAYER CERAMIC CAPACITORS





3.75g  
CO<sub>2</sub>  
MLCC(03A104K) 1piece

**We declare that all our MLCCs are produced in accordance with EU ROHS and REACH Directive.**

- 1. RoHS Compliance and restriction of Br**  
The following restricted materials are not used in packaging materials as well as products in compliance with the law and restriction.  
- Cd, Pb, Hg, Cr6+, As, Br and the compounds, PCB, asbestos
- 2. No use of materials breaking Ozone layer**  
The following ODS materials are not used in our fabrication process.  
- ODS material : Freon, Haron, 1-1-1 TCE, CCl4, HCFC

If you want more detailed Information, Please Visit Samsung Electro-mechanics Website  
[<http://www.semlcr.com>]

Please, see the last page of this catalog for our environmental certification list.

**CONTENTS**

Part Numbering System .....  
 General Capacitors .....  
 High Capacitance Capacitors .....  
 Super Small Size Capacitors .....  
 Medium-High Voltage Capacitors .....  
 Array Type Capacitors .....  
 Low ESL Capacitors .....  
 Reliability Test Condition .....  
 Premium Capacitors for Automotive Applications .....  
 Packaging Specification .....  
 Application Manual for Surface Mounting .....

**4** Part Numbering System  
**6** General Capacitors  
**23** High Capacitance Capacitors  
**37** Super Small Size Capacitors  
**41** Medium-High Voltage Capacitors  
**52** Array Type Capacitors  
**55** Low ESL Capacitors  
**58** Reliability Test Condition  
**62** Premium Capacitors for Automotive Applications  
**78** Packaging Specification  
**82** Application Manual for Surface Mounting

**CL 10 A 106 M P 8 N N N C**  
**1 2 3 4 5 6 7 8 9 10 11**

### 1. SERIES CODE

CL=Multi layer Ceramic Capacitors

### 2. SIZE CODE — inch(mm)

02=01005(0402) 21=0805(2012) 43=1812(4532)  
 03=0201(0603) 31=1206(3216) 55=2220(5750)  
 05=0402(1005) 32=1210(3225)  
 10=0603(1608) 42=1808(4520)

### \* 3. DIELECTRIC CODE

Class I	Class II
C=COG	A=X5R F=Y5V B=X7R X=X6S Y=X7S Z=X7T

### \*\* 4. CAPACITANCE CODE

Capacitance expressed in pF. 2 significant digits plus number of zeros.  
 example) 106=10 × 10<sup>6</sup>=10000000pF  
 For Values < 10pF, Letter R denotes decimal point  
 example) 1R5=1.5pF

### 5. TOLERANCE CODE

B=±0.1pF F=±1pF, ±1%\* K=±10%  
 C=±0.25pF G=±2% M=±20%  
 D=±0.5pF J=±5% Z=+80/-20%

\*For Values ≤ 10pF, F=±1pF  
 Values > 10pF, F=±1%

### 6. RATED VOLTAGE CODE

R=4V O=16V B=50V E=250V H=630V K=3000V  
 Q=6.3V A=25V C=100V F=350V I=1000V  
 P=10V L=35V D=200V G=500V J=2000V

### \*\*\* 7. THICKNESS CODE

2=0.20mm A=0.65mm F=1.25mm L=3.20mm S=1.35mm  
 3=0.30mm C=0.85mm H=1.60mm M=1.15mm U=1.80mm  
 5=0.50mm D=1.00mm I=2.00mm P=1.15mm V=2.50mm  
 8=0.80mm E=1.10mm J=2.50mm Q=1.25mm Y=1.25mm  
 9=0.90mm

### 8. INNER ELECTRODE / TERMINATION / PLATING CODE

A=Normal Product Pd / Ag / Ni barrier / Sn 100%  
 N=Normal Product Ni / Cu / Ni barrier / Sn 100%  
 G=Normal Product Cu / Cu / Ni barrier / Sn 100%  
 L=Low profile Ni / Cu / Ni barrier / Sn 100%  
 S=Normal Product Ni/Cu/Soft termination / Ni barrier / Sn 100%

### 9. PRODUCT CODE

N=Normal  
 A=Array(2-element)  
 B=Array(4-element)  
 L=LICC  
 J=SLIC

Code	*Size tolerance					
	01005(0402)	0201(0603)	0402(1005)	0603(1608)	0805(2012)	1206(3216)
S	±0.03	±0.05	±0.07	±0.07		±0.30
Q	±0.05	±0.07	±0.10	±0.15	±0.15	
R	±0.07	±0.09	±0.15	±0.20	±0.20	
U	±0.09		±0.20	±0.25	±0.30	
Z			±0.40	±0.30		
9			±0.30			

### 10. CONTROL CODE

N=Reserved for future use

### 11. PACKAGING CODE

B=Bulk  
 P=Bulk Case  
 C=Cardboard Tape, 7"Reel  
 H=Cardboard Tape, 7"Reel(15,000ea)  
 O=Cardboard Tape, 10"Reel  
 D=Cardboard Tape, 13"Reel(10,000ea)  
 L=Cardboard Tape, 13"Reel(15,000ea)  
 E=Embossed Type, 7"Reel  
 G=Embossed Type, 7"Reel(3,000ea)  
 F=Embossed Type, 13"Reel  
 S=Embossed Type, 10"Reel

### Class I (Temperature Compensation)

Symbol	EIA Code	Operation Temperature Range(°C)	Temperature Coefficient Range(ppm/°C)
C	COG	-55 ~ +125	0 ±30

### \* Class II (High Dielectric Constant)

Symbol	EIA Code	Operation Temperature Range(°C)	Capacitance Change(ΔC %)
A	X5R	-55 ~ +85	±15
B	X7R	-55 ~ +125	±15
X	X6S	-55 ~ +105	±22
F	Y5V	-30 ~ +85	-82 ~ +22
Y	X7S	-55 ~ +125	±22
Z	X7T	-55 ~ +125	-33 ~ +22

### \*\*

Series	TC	Capacitance Step														
		1.0			1.5			2.2			3.3			4.7		
E-3	Y5V	1.0			2.2			4.7								
E-6	X5R															
	X7R															
	X6S	1.0	1.5	2.2	3.3	4.7	6.8									
	X7S															
E-12	COG	1.0	1.2	1.5	1.8	2.2	2.7	3.3	3.9	4.7	5.6	6.8	8.2			

### \*\*\*

Size	Code	Thickness(mm)	Spec(mm)	Size	Code	Thickness(mm)	Spec(mm)
01005(0402)	2	0.20	±0.02	1210(3225)	C	0.85	±0.10*
0201(0603)	3	0.30	±0.03		9	0.90	±0.10*
0402(1005)	3	0.30	±0.03*		F	1.25	±0.20
	5	0.50	±0.05		S	1.35	±0.15
0603(1608)	5	0.50	+0.0/-0.1*		H	1.60	±0.20
	8	0.80	±0.10		U	1.80	±0.20*
0805(2012)	A	0.65	±0.10		I	2.00	±0.20
	C	0.85	±0.10		J	2.50	±0.20
	C	0.85	±0.10*		V	2.50	±0.30
	M	1.15	±0.10		1808(4520)	F	1.25
	F	1.25	±0.10	H		1.60	±0.20
	Q	1.25	±0.15	I	2.00	±0.20	
1206(3216)	Y	1.25	±0.20	1812(4532)	F	1.25	±0.20
	C	0.85	±0.15		H	1.60	±0.20
		0.85	±0.10*		I	2.00	±0.20
	E	1.10	±0.15	J	2.50	±0.20	
	E	1.10	±0.10*	L	3.20	±0.30	
	P	1.15	±0.10*	2220(5750)	H	1.60	±0.20
	M	1.15	±0.15		I	2.00	±0.20
	F	1.25	±0.15		J	2.50	±0.20
	H	1.60	±0.20		L	3.00	±0.30

- \* Mark is only applicable to "L" code, 12<sup>th</sup> code in part number.
- Please discuss with sales person with regard to Pd products.

Part Numbering System

General Capacitors

High Capacitance Capacitors

Super Small Size Capacitors

Medium-High Voltage Capacitors

Array Type Capacitors

Low ESL Capacitors

Reliability Test Condition

Premium Capacitors for Automotive Applications

Packaging Specification

Application Manual for Surface Mounting

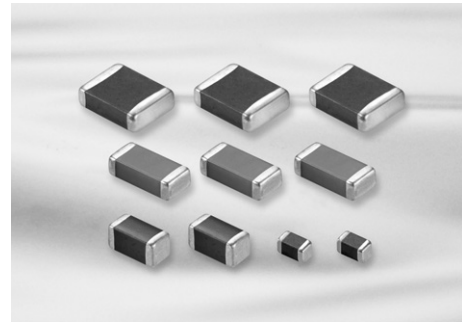

## Feature

- Wide selection of size : from 0402 to 2220
- Highly reliable tolerance and high speed automatic chip placement on PCBs
- Wide capacitance range
- Wide temperature compensation and voltage range : from COG to Y5V and from 6.3V to 50V
- Highly reliable performance
- Highly resistant termination metal
- Tape & reel for surface mount assembly

## Application

- HHP, DSC, DVC, LCD, TV, Memory Module, PDA, Game Machine
- Tuner (Product code C is suitable.)

## Structure and Dimensions

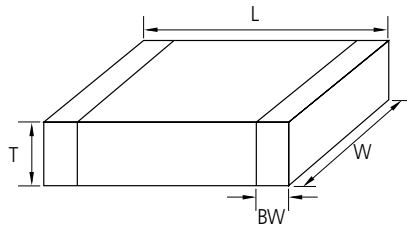

Size Code	EIA Code	Dimension(mm)				
		L	W	T	Thickness Code	BW
05	0402	1.00±0.05	0.50±0.05	0.50±0.05	5	0.25±0.10
10	0603	1.60±0.10	0.80±0.10	0.50±0.0/-0.1(*)	5	0.30±0.20
		1.60±0.10	0.80±0.10	0.80±0.10	8	
21	0805	2.00±0.10	1.25±0.10	0.85±0.10	C	0.5+0.2/-0.3
		2.00±0.10	1.25±0.10	1.15±0.10	M	
		2.00±0.10	1.25±0.10	1.25±0.10	F	
		2.00±0.15	1.25±0.15	1.25±0.15	Q	
		2.00±0.20	1.25±0.20	1.25±0.20	Y	
		3.20±0.20	1.60±0.20	0.60±0.10(*)	6	
31	1206	3.20±0.15	1.60±0.15	0.85±0.15	C	0.50±0.30
		3.20±0.20	1.60±0.20	0.85±0.10(*)	C	
		3.20±0.20	1.60±0.20	1.15±0.10(*)	P	
		3.20±0.15	1.60±0.15	1.25±0.15	F	
		3.20±0.20	1.60±0.20	1.60±0.20	H	
		3.20±0.30	2.50±0.20	0.85±0.10(*)	C	
32	1210	3.20±0.30	2.50±0.20	0.90±0.10(*)	9	0.60±0.30
		3.20±0.30	2.50±0.20	1.60±0.20	H	
		3.20±0.30	2.50±0.20	1.80±0.20(*)	U	
		3.20±0.30	2.50±0.20	2.00±0.20	I	
		3.20±0.30	2.50±0.20	2.50±0.20	J	
		3.20±0.40	2.50±0.30	2.50±0.30	V	
42	1808	4.50±0.40	2.00±0.20	1.25±0.20	F	0.80±0.30
		4.50±0.40	2.00±0.20	1.40±0.20	G	
		4.50±0.40	2.00±0.20	2.00±0.20	I	
43	1812	4.50±0.40	3.20±0.30	1.25±0.20	F	0.80±0.30
		4.50±0.40	3.20±0.30	2.50±0.20	J	
		4.50±0.40	3.20±0.30	3.20±0.30	L	
55	2220	5.70±0.40	5.00±0.40	2.50±0.20	J	1.00±0.30
		5.70±0.40	5.00±0.40	3.20±0.30	L	

■ \* Mark is only applicable to "L" code, 12<sup>th</sup> code in part number.

## General Capacitors Table (COG)

Size(mm)	Vr(V)	Capacitance																					
		pF					nF																
		0.5	1	10	22	47	100	220	330	470	560	1	2.2	3.3	4.7	6.8	10	22	27	33	47	68	100
0402(1005)	25	[Shaded area covering 0.5 to 100 pF]																					
	50	[Shaded area covering 0.5 to 100 pF]																					
0603(1608)	25	[Shaded area covering 0.5 to 22 nF]																					
	50	[Shaded area covering 0.5 to 22 nF]																					
0805(2012)	25	[Shaded area covering 0.5 to 10 nF]																					
	50	[Shaded area covering 0.5 to 10 nF]																					
1206(3216)	16	[Shaded area covering 0.5 to 10 nF]																					
	25	[Shaded area covering 0.5 to 10 nF]																					
	50	[Shaded area covering 0.5 to 10 nF]																					
1210(3225)	50	[Shaded area covering 0.5 to 10 nF]																					
1812(4532)	25	[Shaded area covering 0.5 to 10 nF]																					
	50	[Shaded area covering 0.5 to 10 nF]																					
2220(5750)	50	[Shaded area covering 0.5 to 10 nF]																					

※ For parts of higher capacitance than those above listed, refer to the product lineup of 'High Capacitance' subcategory.

Part Numbering System

General Capacitors

High Capacitance Capacitors

Super Small Size Capacitors

Medium-High Voltage Capacitors

Array Type Capacitors

Low ESL Capacitors

Reliability Test Condition

Premium Capacitors for Automotive Applications

Packaging Specification

Application Manual for Surface Mounting

General Capacitors Table (X5R)

Size(mm)	Vr(V)	Capacitance (μF)										
		0.1	0.22	0.47	1	2.2	4.7	10	22	47	100	
0402(1005)	4											
	6.3											
	10											
	16											
	25											
0603(1608)	4											
	6.3											
	10											
	16											
	25											
	50											
0805(2012)	4											
	6.3											
	10											
	16											
	25											
	50											
1206(3216)	6.3											
	10											
	16											
	25											
	50											
1210(3225)	6.3											
	10											
	16											
	25											

※ For parts of higher capacitance than those above listed, refer to the product lineup of 'High Capacitance' subcategory.

General Capacitors Table -Low Profile (X5R)

Size(mm)	Tmax (mm)	Vr(V)	Capacitance (μF)						
			1	2.2	4.7	10	22	47	
0402(1005)	0.33	6.3	X6S						
		10							
		16							
0603(1608)	0.5	6.3							
		10							
		16							
	0.7	10							
		16							
		25							
0805(2012)	0.85	25							
		4							(Tmax=1.0)
	0.95	6.3							(Tmax=1.0)
		10							
		16							
1206(3216)	0.95	25							X6S
		50							(Tmax=1.0)
		100							(Tmax=1.0)
	2.0	16							
		25							
		35							
	50								

※ For parts of higher capacitance than those above listed, refer to the product lineup of 'High Capacitance' subcategory.

- Part Numbering System
- General Capacitors**
- High Capacitance Capacitors
- Super Small Size Capacitors
- Medium-High Voltage Capacitors
- Array Type Capacitors
- Low ESL Capacitors
- Reliability Test Condition
- Premium Capacitors for Automotive Applications
- Packaging Specification
- Application Manual for Surface Mounting

General Capacitors Table (X6S)

Size(mm)	Vr(V)	Capacitance (μF)										
		0.1	0.22	0.47	1	2.2	4.7	10	22	47	100	
0402(1005)	4											
	6.3											
	10											
0603(1608)	4											
	6.3											
	10											
	16											
	25											
0805(2012)	4											
	6.3											
	10											
	16											
	25											
1206(3216)	6.3											
	10											
	16											
	25											
1210(3225)	6.3											
	10											
	16											
	25											

※ For parts of higher capacitance than those above listed, refer to the product lineup of 'High Capacitance' subcategory.

General Capacitors Table (X7R)

Size(mm)	Vr(V)	Capacitance (μF)										
		0.1	0.22	0.47	1	2.2	4.7	10	22	47	100	
0402(1005)	6.3											
	10			X7S								
	16											
0603(1608)	6.3											
	10											
	16											
	25											
	50											
0805(2012)	6.3											
	10											
	16											
	25								X7S			
	35											
	50											
1206(3216)	6.3											
	10											
	16											
	25											
	50											
1210(3225)	6.3											X7T
	10											
	16											
	25											
	50											

※ For parts of higher capacitance than those above listed, refer to the product lineup of 'High Capacitance' subcategory.

- Part Numbering System
- General Capacitors**
- High Capacitance Capacitors
- Super Small Size Capacitors
- Medium-High Voltage Capacitors
- Array Type Capacitors
- Low ESL Capacitors
- Reliability Test Condition
- Premium Capacitors for Automotive Applications
- Packaging Specification
- Application Manual for Surface Mounting

General Capacitors Table (Y5V)

Size(mm)	Vr(V)	Capacitance (μF)									
		0.1	0.22	0.47	1	2.2	4.7	10	22	47	
0402(1005)	6.3										
	10										
	16										
	25										
0603(1608)	6.3										
	10										
	16										
	25										
	50										
0805(2012)	6.3										
	10										
	16										
	25										
	50										
1206(3216)	10										
	16										
	25										
	50										
1210(3225)	6.3										
	10										
	16										
	25										
	35										
	50										

※ For parts of higher capacitance than those above listed, refer to the product lineup of 'High Capacitance' subcategory.

Product Lineup (General Capacitors-C0G)

	Part Number	Size L×W (mm)	Capacitance	Rated Voltage (Vdc)	Capacitance Tolerance	Thickness Max. (mm)
1	CL05C0R5CB5NNN □	1.00×0.50	0.5pF	50	±0.25pF	0.55
2	CL05CR75CB5NNN □		0.75pF	50	±0.25pF	0.55
3	CL05C010CB5NNN □		1.0pF	50	±0.25pF	0.55
4	CL05C1R2CB5NNN □		1.2pF	50	±0.25pF	0.55
5	CL05C1R5CB5NNN □		1.5pF	50	±0.25pF	0.55
6	CL05C1R8CB5NNN □		1.8pF	50	±0.25pF	0.55
7	CL05C020CB5NNN □		2.0pF	50	±0.25pF	0.55
8	CL05C2R2CB5NNN □		2.2pF	50	±0.25pF	0.55
9	CL05C2R4CB5NNN □		2.4pF	50	±0.25pF	0.55
10	CL05C2R5CB5NNN □		2.5pF	50	±0.25pF	0.55
11	CL05C2R7CB5NNN □		2.7pF	50	±0.25pF	0.55
12	CL05C030CB5NNN □		3.0pF	50	±0.25pF	0.55
13	CL05C3R3CB5NNN □		3.3pF	50	±0.25pF	0.55
14	CL05C3R5CB5NNN □		3.5pF	50	±0.25pF	0.55
15	CL05C3R6CB5NNN □		3.6pF	50	±0.25pF	0.55
16	CL05C3R9CB5NNN □		3.9pF	50	±0.25pF	0.55
17	CL05C040CB5NNN □		4.0pF	50	±0.25pF	0.55
18	CL05C4R3CB5NNN □		4.3pF	50	±0.25pF	0.55
19	CL05C4R7CB5NNN □		4.7pF	50	±0.25pF	0.55
20	CL05C050DB5NNN □		5.0pF	50	±0.5pF	0.55
21	CL05C5R6DB5NNN □		5.6pF	50	±0.5pF	0.55
22	CL05C060DB5NNN □		6.0pF	50	±0.5pF	0.55
23	CL05C6R2DB5NNN □		6.2pF	50	±0.5pF	0.55
24	CL05C6R8DB5NNN □		6.8pF	50	±0.5pF	0.55
25	CL05C070DB5NNN □		7.0pF	50	±0.5pF	0.55
26	CL05C080DB5NNN □		8.0pF	50	±0.5pF	0.55
27	CL05C8R2DB5NNN □		8.2pF	50	±0.5pF	0.55
28	CL05C090DB5NNN □		9.0pF	50	±0.5pF	0.55
29	CL05C9R1DB5NNN □		9.1pF	50	±0.5pF	0.55
30	CL05C100JB5NNN □		10pF	50	±5%	0.55
31	CL05C110JB5NNN □		11pF	50	±5%	0.55
32	CL05C120JB5NNN □		12pF	50	±5%	0.55
33	CL05C130JB5NNN □		13pF	50	±5%	0.55
34	CL05C150JB5NNN □		15pF	50	±5%	0.55
35	CL05C160JB5NNN □		16pF	50	±5%	0.55
36	CL05C180JB5NNN □		18pF	50	±5%	0.55
37	CL05C200JB5NNN □		20pF	50	±5%	0.55
38	CL05C220JA5NNN □		22pF	25	±5%	0.55
39	CL05C220JB5NNN □		22pF	50	±5%	0.55
40	CL05C240JB5NNN □		24pF	50	±5%	0.55
41	CL05C270JB5NNN □		27pF	50	±5%	0.55
42	CL05C270JA5NNN □		27pF	25	±5%	0.55
43	CL05C300JB5NNN □		30pF	50	±5%	0.55
44	CL05C330JB5NNN □		33pF	50	±5%	0.55
45	CL05C360JB5NNN □		36pF	50	±5%	0.55
46	CL05C390JB5NNN □		39pF	50	±5%	0.55
47	CL05C430JB5NNN □		43pF	50	±5%	0.55
48	CL05C470JB5NNN □		47pF	50	±5%	0.55
49	CL05C510JB5NNN □		51pF	50	±5%	0.55
50	CL05C560JB5NNN □		56pF	50	±5%	0.55

※ □ mark means packaging code. If you want to learn the code or quantity in detail, please see p80.

※ For parts of higher capacitance than those above listed, refer to the product lineup of 'High Capacitance' subcategory.

- Part Numbering System
- General Capacitors
- High Capacitance Capacitors
- Super Small Size Capacitors
- Medium-High Voltage Capacitors
- Array Type Capacitors
- Low ESL Capacitors
- Reliability Test Condition
- Premium Capacitors for Automotive Applications
- Packaging Specification
- Application Manual for Surface Mounting

Product Lineup (General Capacitors-C0G)

	Part Number	Size L × W (mm)	Capacitance	Rated Voltage (Vdc)	Capacitance Tolerance	Thickness Max. (mm)
51	CL05C620JB5NNN □	1.00×0.50	62pF	50	±5%	0.55
52	CL05C680JB5NNN □		68pF	50	±5%	0.55
53	CL05C750JB5NNN □		75pF	50	±5%	0.55
54	CL05C820JB5NNN □		82pF	50	±5%	0.55
55	CL05C910JB5NNN □		91pF	50	±5%	0.55
56	CL05C101JB5NNN □		100pF	50	±5%	0.55
57	CL05C121JB5NNN □		120pF	50	±5%	0.55
58	CL05C151JB5NNN □		150pF	50	±5%	0.55
59	CL05C181JB5NNN □		180pF	50	±5%	0.55
60	CL05C201JB5NNN □		200pF	50	±5%	0.55
61	CL05C221JB5NNN □		220pF	50	±5%	0.55
62	CL05C271JB5NNN □		270pF	50	±5%	0.55
63	CL05C331JB5NNN □		330pF	50	±5%	0.55
64	CL05C391JB5NNN □		390pF	50	±5%	0.55
65	CL05C471JB5NNN □		470pF	50	±5%	0.55
66	CL05C471JO5NNN □		470pF	16	±5%	0.55
67	CL05C681JB5NNN □		680pF	50	±5%	0.55
68	CL05C821JB5NNN □		820pF	50	±5%	0.55
69	CL05C102JB5NNN □		1nF	50	±5%	0.55
70	CL05C102JA5NNN □		1nF	25	±5%	0.55
71	CL05C102JO5NNN □		1nF	16	±5%	0.55
1	CL10C0R3CB8NNN □	1.60×0.80	0.3pF	50	±0.25pF	0.90
2	CL10C0R5CB8NNN □		0.5pF	50	±0.25pF	0.90
3	CL10CR75CB8NNN □		0.75pF	50	±0.25pF	0.90
4	CL10C010CB8NNN □		1.0pF	50	±0.25pF	0.90
5	CL10C1R2CB8NNN □		1.2pF	50	±0.25pF	0.90
6	CL10C1R5CB8NNN □		1.5pF	50	±0.25pF	0.90
7	CL10C1R8CB8NNN □		1.8pF	50	±0.25pF	0.90
8	CL10C020CB8NNN □		2.0pF	50	±0.25pF	0.90
9	CL10C2R2CB8NNN □		2.2pF	50	±0.25pF	0.90
10	CL10C2R4CB8NNN □		2.4pF	50	±0.25pF	0.90
11	CL10C2R5CB8NNN □		2.5pF	50	±0.25pF	0.90
12	CL10C2R7CB8NNN □		2.7pF	50	±0.25pF	0.90
13	CL10C030CB8NNN □		3.0pF	50	±0.25pF	0.90
14	CL10C3R3CB8NNN □		3.3pF	50	±0.25pF	0.90
15	CL10C3R5CB8NNN □		3.5pF	50	±0.25pF	0.90
16	CL10C3R6CB8NNN □		3.6pF	50	±0.25pF	0.90
17	CL10C3R9CB8NNN □		3.9pF	50	±0.25pF	0.90
18	CL10C040CB8NNN □		4.0pF	50	±0.25pF	0.90
19	CL10C4R3CB8NNN □		4.3pF	50	±0.25pF	0.90
20	CL10C4R7CB8NNN □		4.7pF	50	±0.25pF	0.90
21	CL10C050DB8NNN □		5.0pF	50	±0.5pF	0.90
22	CL10C5R6DB8NNN □		5.6pF	50	±0.5pF	0.90
23	CL10C060DB8NNN □		6.0pF	50	±0.5pF	0.90
24	CL10C6R2DB8NNN □		6.2pF	50	±0.5pF	0.90
25	CL10C6R8DB8NNN □		6.8pF	50	±0.5pF	0.90
26	CL10C070DB8NNN □		7.0pF	50	±0.5pF	0.90
27	CL10C7R5DB8NNN □		7.5pF	50	±0.5pF	0.90
28	CL10C080DB8NNN □		8.0pF	50	±0.5pF	0.90
29	CL10C8R2DB8NNN □		8.2pF	50	±0.5pF	0.90

※ □ mark means packaging code. If you want to learn the code or quantity in detail, please see p80.

※ For parts of higher capacitance than those above listed, refer to the product lineup of 'High Capacitance' subcategory.

Product Lineup (General Capacitors-C0G)

	Part Number	Size L × W (mm)	Capacitance	Rated Voltage (Vdc)	Capacitance Tolerance	Thickness Max. (mm)
30	CL10C090DB8NNN □	1.60×0.80	9.0pF	50	±0.5pF	0.90
31	CL10C9R1DB8NNN □		9.1pF	50	±0.5pF	0.90
32	CL10C100JB8NNN □		10pF	50	±5%	0.90
33	CL10C110JB8NNN □		11pF	50	±5%	0.90
34	CL10C120JB8NNN □		12pF	50	±5%	0.90
35	CL10C130JB8NNN □		13pF	50	±5%	0.90
36	CL10C140JB8NNN □		14pF	50	±5%	0.90
37	CL10C150JB8NNN □		15pF	50	±5%	0.90
38	CL10C160JB8NNN □		16pF	50	±5%	0.90
39	CL10C180JB8NNN □		18pF	50	±5%	0.90
40	CL10C200JB8NNN □		20pF	50	±5%	0.90
41	CL10C220JB8NNN □		22pF	50	±5%	0.90
42	CL10C240JB8NNN □		24pF	50	±5%	0.90
43	CL10C250JB8NNN □		25pF	50	±5%	0.90
44	CL10C270JB8NNN □		27pF	50	±5%	0.90
45	CL10C300JB8NNN □		30pF	50	±5%	0.90
46	CL10C330JB8NNN □		33pF	50	±5%	0.90
47	CL10C360JB8NNN □		36pF	50	±5%	0.90
48	CL10C390JB8NNN □		39pF	50	±5%	0.90
49	CL10C430JB8NNN □		43pF	50	±5%	0.90
50	CL10C470JB8NNN □		47pF	50	±5%	0.90
51	CL10C510JB8NNN □		51pF	50	±5%	0.90
52	CL10C560JB8NNN □		56pF	50	±5%	0.90
53	CL10C620JB8NNN □		62pF	50	±5%	0.90
54	CL10C680JB8NNN □		68pF	50	±5%	0.90
55	CL10C750JB8NNN □		75pF	50	±5%	0.90
56	CL10C820JB8NNN □		82pF	50	±5%	0.90
57	CL10C910JB8NNN □		91pF	50	±5%	0.90
58	CL10C101JB8NNN □		100pF	50	±5%	0.90
59	CL10C111JB8NNN □	110pF	50	±5%	0.90	
60	CL10C121JB8NNN □	120pF	50	±5%	0.90	
61	CL10C131JB8NNN □	130pF	50	±5%	0.90	
62	CL10C151JB8NNN □	150pF	50	±5%	0.90	
63	CL10C161JB8NNN □	160pF	50	±5%	0.90	
64	CL10C181JB8NNN □	180pF	50	±5%	0.90	
65	CL10C201JB8NNN □	200pF	50	±5%	0.90	
66	CL10C221JB8NNN □	220pF	50	±5%	0.90	
67	CL10C241JB8NNN □	240pF	50	±5%	0.90	
68	CL10C271JB8NNN □	270pF	50	±5%	0.90	
69	CL10C301JB8NNN □	300pF	50	±5%	0.90	
70	CL10C331JB8NNN □	330pF	50	±5%	0.90	
71	CL10C361JB8NNN □	360pF	50	±5%	0.90	
72	CL10C391JB8NNN □	390pF	50	±5%	0.90	
73	CL10C431JB8NNN □	430pF	50	±5%	0.90	
74	CL10C471JB8NNN □	470pF	50	±5%	0.90	
75	CL10C511JB8NNN □	510pF	50	±5%	0.90	
76	CL10C561JB8NNN □	560pF	50	±5%	0.90	
77	CL10C621JB8NNN □	620pF	50	±5%	0.90	
78	CL10C681JB8NNN □	680pF	50	±5%	0.90	
79	CL10C751JB8NNN □	750pF	50	±5%	0.90	

※ □ mark means packaging code. If you want to learn the code or quantity in detail, please see p80.

※ For parts of higher capacitance than those above listed, refer to the product lineup of 'High Capacitance' subcategory.

- Part Numbering System
- General Capacitors
- High Capacitance Capacitors
- Super Small Size Capacitors
- Medium-High Voltage Capacitors
- Array Type Capacitors
- Low ESL Capacitors
- Reliability Test Condition
- Premium Capacitors for Automotive Applications
- Packaging Specification
- Application Manual for Surface Mounting



Product Lineup (General Capacitors-C0G)

	Part Number	Size L×W (mm)	Capacitance	Rated Voltage (Vdc)	Capacitance Tolerance	Thickness Max. (mm)
80	CL10C821JB8NND □	1.60×0.80	820pF	50	±5%	0.90
81	CL10C102JB8NND □		1nF	50	±5%	0.90
82	CL10C182JB8NND □		1.8nF	50	±5%	0.90
83	CL10C222JB8NND □		2.2nF	50	±5%	0.90
84	CL10C562JB8NND □		5.6nF	50	±5%	0.90
85	CL10C103JA8NND □		10nF	25	±5%	0.90
1	CL21CR47CBANND □	2.00×1.25	0.47pF	50	±0.25pF	0.75
2	CL21C0R5CBANND □		0.5pF	50	±0.25pF	0.75
3	CL21C010CBANND □		1.0pF	50	±0.25pF	0.75
4	CL21C1R2CBANND □		1.2pF	50	±0.25pF	0.75
5	CL21C1R5CBANND □		1.5pF	50	±0.25pF	0.75
6	CL21C1R8CBANND □		1.8pF	50	±0.25pF	0.75
7	CL21C020CBANND □		2.0pF	50	±0.25pF	0.75
8	CL21C2R2CBANND □		2.2pF	50	±0.25pF	0.75
9	CL21C2R4CBANND □		2.4pF	50	±0.25pF	0.75
10	CL21C2R5CBANND □		2.5pF	50	±0.25pF	0.75
11	CL21C2R7CBANND □		2.7pF	50	±0.25pF	0.75
12	CL21C030CBANND □		3.0pF	50	±0.25pF	0.75
13	CL21C3R2CBANND □		3.2pF	50	±0.25pF	0.75
14	CL21C3R3CBANND □		3.3pF	50	±0.25pF	0.75
15	CL21C3R6CBANND □		3.6pF	50	±0.25pF	0.75
16	CL21C3R9CBANND □		3.9pF	50	±0.25pF	0.75
17	CL21C040CBANND □		4.0pF	50	±0.25pF	0.75
18	CL21C4R7CBANND □		4.7pF	50	±0.25pF	0.75
19	CL21C5R6DBANND □		5.6pF	50	±0.5pF	0.75
20	CL21C060DBANND □		6.0pF	50	±0.5pF	0.75
21	CL21C6R8DBANND □		6.8pF	50	±0.5pF	0.75
22	CL21C070DBANND □		7.0pF	50	±0.5pF	0.75
23	CL21C7R5DBANND □		7.5pF	50	±0.5pF	0.75
24	CL21C080DBANND □		8.0pF	50	±0.5pF	0.75
25	CL21C8R2DBANND □		8.2pF	50	±0.5pF	0.75
26	CL21C090DBANND □		9.0pF	50	±0.5pF	0.75
27	CL21C100JBANND □		10pF	50	±5%	0.75
28	CL21C120JBANND □		12pF	50	±5%	0.75
29	CL21C130JBANND □		13pF	50	±5%	0.75
30	CL21C140JBANND □		14pF	50	±5%	0.75
31	CL21C150JBANND □		15pF	50	±5%	0.75
32	CL21C160JBANND □		16pF	50	±5%	0.75
33	CL21C180JBANND □		18pF	50	±5%	0.75
34	CL21C200JBANND □		20pF	50	±5%	0.75
35	CL21C220JBANND □		22pF	50	±5%	0.75
36	CL21C240JBANND □		24pF	50	±5%	0.75
37	CL21C250JBANND □		25pF	50	±5%	0.75
38	CL21C270JBANND □		27pF	50	±5%	0.75
39	CL21C300JBANND □		30pF	50	±5%	0.75
40	CL21C330JBANND □		33pF	50	±5%	0.75
41	CL21C360JBANND □		36pF	50	±5%	0.75
42	CL21C390JBANND □		39pF	50	±5%	0.75
43	CL21C430JBANND □		43pF	50	±5%	0.75
44	CL21C470JBANND □		47pF	50	±5%	0.75
45	CL21C510JBANND □		51pF	50	±5%	0.75

※ □ mark means packaging code. If you want to learn the code or quantity in detail, please see p80.

※ For parts of higher capacitance than those above listed, refer to the product lineup of 'High Capacitance' subcategory.

Product Lineup (General Capacitors-C0G)

	Part Number	Size L×W (mm)	Capacitance	Rated Voltage (Vdc)	Capacitance Tolerance	Thickness Max. (mm)	
46	CL21C560JBANND □	2.00×1.25	56pF	50	±5%	0.75	
47	CL21C620JBANND □		62pF	50	±5%	0.75	
48	CL21C680JBANND □		68pF	50	±5%	0.75	
49	CL21C750JBANND □		75pF	50	±5%	0.75	
50	CL21C820JBANND □		82pF	50	±5%	0.75	
51	CL21C910JBANND □		91pF	50	±5%	0.75	
52	CL21C101JBANND □		100pF	50	±5%	0.75	
53	CL21C111JBANND □		110pF	50	±5%	0.75	
54	CL21C121JBANND □		120pF	50	±5%	0.75	
55	CL21C131JBANND □		130pF	50	±5%	0.75	
56	CL21C151JBANND □		150pF	50	±5%	0.75	
57	CL21C161JBANND □		160pF	50	±5%	0.75	
58	CL21C181JBANND □		180pF	50	±5%	0.75	
59	CL21C201JBANND □		200pF	50	±5%	0.75	
60	CL21C221JBANND □		220pF	50	±5%	0.75	
61	CL21C241JBANND □		240pF	50	±5%	0.75	
62	CL21C271JBANND □		270pF	50	±5%	0.75	
63	CL21C301JBANND □		300pF	50	±5%	0.75	
64	CL21C331JBANND □		330pF	50	±5%	0.75	
65	CL21C361JBANND □		360pF	50	±5%	0.75	
66	CL21C391JBANND □		390pF	50	±5%	0.75	
67	CL21C431JBANND □		430pF	50	±5%	0.75	
68	CL21C471JBANND □		470pF	50	±5%	0.75	
69	CL21C511JBANND □		510pF	50	±5%	0.75	
70	CL21C561JBANND □		560pF	50	±5%	0.75	
71	CL21C621JBCNND □		620pF	50	±5%	0.95	
72	CL21C681JBCNND □		680pF	50	±5%	0.95	
73	CL21C751JBCNND □		750pF	50	±5%	0.95	
74	CL21C821JBCNND □		820pF	50	±5%	0.95	
75	CL21C102JBCNND □		1nF	50	±5%	0.95	
76	CL21C122JBFNND □		1.2nF	50	±5%	1.35	
77	CL21C152JBFNND □		1.5nF	50	±5%	1.35	
78	CL21C182JBFNND □		1.8nF	50	±5%	1.35	
79	CL21C222JBFNND □		2.2nF	50	±5%	1.35	
80	CL21C332JAFNND □		3.3nF	25	±5%	1.35	
81	CL21C332JBFNND □		3.3nF	50	±5%	1.35	
82	CL21C392JANND □		3.9nF	25	±5%	0.75	
83	CL21C392JBFNND □		3.9nF	50	±5%	1.35	
84	CL21C472JBFNND □		4.7nF	50	±5%	1.35	
85	CL21C562JBFNND □		5.6nF	50	±5%	1.35	
86	CL21C822JAFNND □		8.2nF	25	±5%	1.35	
87	CL21C103JBFNND □		10nF	50	±5%	1.35	
88	CL21C333JAFNND □		33nF	25	±5%	1.35	
1	CL31C0R5CBCNND □		3.20×1.60	0.5pF	50	±0.25pF	1.0
2	CL31C010CBCNND □			1.0pF	50	±0.25pF	1.0
3	CL31C1R5CBCNND □			1.5pF	50	±0.25pF	1.0
4	CL31C1R8CBCNND □			1.8pF	50	±0.25pF	1.0
5	CL31C020CBCNND □			2.0pF	50	±0.25pF	1.0
6	CL31C2R2CBCNND □	2.2pF		50	±0.25pF	1.0	
7	CL31C2R7CBCNND □	2.7pF		50	±0.25pF	1.0	

※ □ mark means packaging code. If you want to learn the code or quantity in detail, please see p80.

※ For parts of higher capacitance than those above listed, refer to the product lineup of 'High Capacitance' subcategory.

Part Numbering System

General Capacitors

High Capacitance Capacitors

Super Small Size Capacitors

Medium-High Voltage Capacitors

Array Type Capacitors

Low ESL Capacitors

Reliability Test Condition

Premium Capacitors for Automotive Applications

Packaging Specification

Application Manual for Surface Mounting

Product Lineup (General Capacitors-C0G)

	Part Number	Size L×W (mm)	Capacitance	Rated Voltage (Vdc)	Capacitance Tolerance	Thickness Max. (mm)	
8	CL31C030CBCNNN □	3.20×1.60	3.0pF	50	±0.25pF	1.0	
9	CL31C3R3CBCNNN □		3.3pF	50	±0.25pF	1.0	
10	CL31C040CBCNNN □		4.0pF	50	±0.25pF	1.0	
11	CL31C4R7CBCNNN □		4.7pF	50	±0.25pF	1.0	
12	CL31C100JBCNNN □		10pF	50	±5%	1.0	
13	CL31C120JBCNNN □		12pF	50	±5%	1.0	
14	CL31C150JBCNNN □		15pF	50	±5%	1.0	
15	CL31C180JBCNNN □		18pF	50	±5%	1.0	
16	CL31C200JBCNNN □		20pF	50	±5%	1.0	
17	CL31C220JBCNNN □		22pF	50	±5%	1.0	
18	CL31C270JBCNNN □		27pF	50	±5%	1.0	
19	CL31C300JBCNNN □		30pF	50	±5%	1.0	
20	CL31C330JBCNNN □		33pF	50	±5%	1.0	
21	CL31C390JBCNNN □		39pF	50	±5%	1.0	
22	CL31C470JBCNNN □		47pF	50	±5%	1.0	
23	CL31C510JBCNNN □		51pF	50	±5%	1.0	
24	CL31C560JBCNNN □		56pF	50	±5%	1.0	
25	CL31C680JBCNNN □		68pF	50	±5%	1.0	
26	CL31C750JBCNNN □		75pF	50	±5%	1.0	
27	CL31C820JBCNNN □		82pF	50	±5%	1.0	
28	CL31C101JBCNNN □		100pF	50	±5%	1.0	
29	CL31C121JBCNNN □		120pF	50	±5%	1.0	
30	CL31C151JBCNNN □		150pF	50	±5%	1.0	
31	CL31C181JBCNNN □		180pF	50	±5%	1.0	
32	CL31C221JBCNNN □		220pF	50	±5%	1.0	
33	CL31C271JBCNNN □		270pF	50	±5%	1.0	
34	CL31C331JBCNNN □		330pF	50	±5%	1.0	
35	CL31C391JBCNNN □		390pF	50	±5%	1.0	
36	CL31C471JBCNNN □		470pF	50	±5%	1.0	
37	CL31C561JBCNNN □		560pF	50	±5%	1.0	
38	CL31C681JBCNNN □		680pF	50	±5%	1.0	
39	CL31C821JBCNNN □		820pF	50	±5%	1.0	
40	CL31C102JBCNNN □		1nF	50	±5%	1.0	
41	CL31C122JBCNNN □		1.2nF	50	±5%	1.0	
42	CL31C152JBCNNN □		1.5nF	50	±5%	1.0	
43	CL31C182JBCNNN □		1.8nF	50	±5%	1.0	
44	CL31C222JBCNNN □		2.2nF	50	±5%	1.0	
45	CL31C272JBFNNN □		2.7nF	50	±5%	1.4	
46	CL31C332JBFNNN □		3.3nF	50	±5%	1.4	
47	CL31C472JBFNNN □		4.7nF	50	±5%	1.4	
48	CL31C682JBHNNN □		6.8nF	50	±5%	1.8	
49	CL31C103JAFNNN □		10nF	25	±5%	1.4	
50	CL31C223JBHNNN □		22nF	50	±5%	1.8	
51	CL31C333JBHNNN □		33nF	50	±5%	1.8	
52	CL31C473JBHNNN □		47nF	50	±5%	1.8	
53	CL31C683JAHNNN □		68nF	25	±5%	1.8	
54	CL31C104JAHNNN □		100nF	25	±5%	1.8	
1	CL32C472JBFNNN □		3.20×2.50	4.7nF	50	±5%	1.45
2	CL32C103JBFNNN □			10nF	50	±5%	1.45
3	CL32C223JBHNNN □			22nF	50	±5%	1.80
4	CL32C333JBHNNN □			33nF	50	±5%	1.8
5	CL32C473JBHNNN □			47nF	50	±5%	1.8

□ mark means packaging code. If you want to learn the code or quantity in detail, please see p80.

※ For parts of higher capacitance than those above listed, refer to the product lineup of 'High Capacitance' subcategory.

Product Lineup (General Capacitors-X7R)

	Part Number	Size L×W (mm)	Capacitance	Rated Voltage (Vdc)	Capacitance Tolerance	Thickness Max. (mm)
1	CL05B471KB5NNN □	1.00×0.50	470pF	50	±10%	0.55
2	CL05B221KB5NNN □		220pF	50	±10%	0.55
3	CL05B681KB5NNN □		680pF	50	±10%	0.55
4	CL05B102KB5NNN □		1nF	50	±10%	0.55
5	CL05B102KA5NNN □		1nF	25	±10%	0.55
6	CL05B222KB5NNN □		2.2nF	50	±10%	0.55
7	CL05B472KB5NNN □		4.7nF	50	±10%	0.55
8	CL05B472KA5NNN □		4.7nF	25	±10%	0.55
9	CL05B682KB5NNN □		6.8nF	50	±10%	0.55
10	CL05B682KA5NNN □		6.8nF	25	±10%	0.55
11	CL05B103KB5NNN □		10nF	50	±10%	0.55
12	CL05B103KA5NNN □		10nF	25	±10%	0.55
13	CL05B223KA5NNN □		22nF	25	±10%	0.55
14	CL05B473KO5NNN □		47nF	16	±10%	0.55
15	CL05B473KP5NNN □		47nF	10	±10%	0.55
16	CL05B683KO5NNN □		68nF	16	±10%	0.55
17	CL05B683KP5NNN □		68nF	10	±10%	0.55
18	CL05B104KO5NNN □		100nF	16	±10%	0.55
19	CL05B104KP5NNN □		100nF	10	±10%	0.55
20	CL05B104KQ5NNN □		100nF	6.3	±10%	0.55
1	CL10B101KB8NNN □	1.60×0.80	100pF	50	±10%	0.9
2	CL10B221KB8NNN □		220pF	50	±10%	0.9
3	CL10B471KB8NNN □		470pF	50	±10%	0.9
4	CL10B681KB8NNN □		680pF	50	±10%	0.9
5	CL10B102KB8NNN □		1nF	50	±10%	0.9
6	CL10B102KA8NNN □		1nF	25	±10%	0.9
7	CL10B222KB8NNN □		2.2nF	50	±10%	0.9
8	CL10B472KB8NNN □		4.7nF	50	±10%	0.9
9	CL10B472KA8NNN □		4.7nF	25	±10%	0.9
10	CL10B682KB8NNN □		6.8nF	50	±10%	0.9
11	CL10B103KB8NNN □		10nF	50	±10%	0.9
12	CL10B103KA8NNN □		10nF	25	±10%	0.9
13	CL10B223KA8NNN □		22nF	25	±10%	0.9
14	CL10B473KB8NNN □		47nF	50	±10%	0.9
15	CL10B473KA8NNN □		47nF	25	±10%	0.9
16	CL10B683KB8NNN □		68nF	50	±10%	0.9
17	CL10B683KA8NNN □		68nF	25	±10%	0.9
18	CL10B104KB8NNN □		100nF	50	±10%	0.9
19	CL10B224KA8NNN □		220nF	25	±10%	0.9
20	CL10B224KO8NNN □		220nF	16	±10%	0.9
21	CL10B225KP8NNN □		2.2μF	10	±10%	0.9
1	CL21B221KBANNN □	2.00×1.25	220pF	50	±10%	0.75
2	CL21B471KBANNN □		470pF	50	±10%	0.75
3	CL21B681KBANNN □		680pF	50	±10%	0.75
4	CL21B102KBANNN □		1nF	50	±10%	0.75
5	CL21B102KBCNNN □		1nF	50	±10%	0.95
6	CL21B222KBANNN □		2.2nF	50	±10%	0.75
7	CL21B222KBCNNN □		2.2nF	50	±10%	0.95
8	CL21B682KBANNN □		6.8nF	50	±10%	0.75
9	CL21B103KBANNN □		10nF	50	±10%	0.75

□ mark means packaging code. If you want to learn the code or quantity in detail, please see p80.

※ For parts of higher capacitance than those above listed, refer to the product lineup of 'High Capacitance' subcategory.

Part Numbering System

General Capacitors

High Capacitance Capacitors

Super Small Size Capacitors

Medium-High Voltage Capacitors

Array Type Capacitors

Low ESL Capacitors

Reliability Test Condition

Premium Capacitors for Automotive Applications

Packaging Specification

Application Manual for Surface Mounting

Product Lineup (General Capacitors-X7R)

	Part Number	Size L × W (mm)	Capacitance	Rated Voltage (Vdc)	Capacitance Tolerance	Thickness Max. (mm)	
10	CL21B103KBCNNN □	2.00×1.25	10nF	50	±10%	0.95	
11	CL21B223KBANNN □		22nF	50	±10%	0.75	
12	CL21B223KBCNNN □		22nF	50	±10%	0.95	
13	CL21B473KBANNN □		47nF	50	±10%	0.75	
14	CL21B473KBCNNN □		47nF	50	±10%	0.95	
15	CL21B683KAANNN □		68nF	25	±10%	0.75	
16	CL21B683KBCNNN □		68nF	50	±10%	0.95	
17	CL21B683KBFNNN □		68nF	50	±10%	1.35	
18	CL21B104KBCNNN □		100nF	50	±10%	0.95	
19	CL21B104KBFNNN □		100nF	50	±10%	1.35	
20	CL21B224KBFNNN □		220nF	50	±10%	1.35	
21	CL21B224KAFNNN □		220nF	25	±10%	1.35	
22	CL21B224KOCNNN □		220nF	16	±10%	0.95	
23	CL21B224KOFNNN □		220nF	16	±10%	1.35	
24	CL21B474KBFNNN □		470nF	50	±10%	1.35	
25	CL21B474KAFNNN □		470nF	25	±10%	1.35	
26	CL21B474KOFNNN □		470nF	16	±10%	1.35	
27	CL21B684KOFNNN □		680nF	16	±10%	1.35	
28	CL21B684KPFNNN □		680nF	10	±10%	1.35	
1	CL31B221KBCNNN □		3.20×1.60	220pF	50	±10%	1.0
2	CL31B471KBCNNN □			470pF	50	±10%	1.0
3	CL31B681KBCNNN □			680pF	50	±10%	1.0
4	CL31B102KBCNNN □			1nF	50	±10%	1.0
5	CL31B222KBCNNN □			2.2nF	50	±10%	1.0
6	CL31B472KBCNNN □			4.7nF	50	±10%	1.0
7	CL31B682KBCNNN □			6.8nF	50	±10%	1.0
8	CL31B103KBCNNN □			10nF	50	±10%	1.0
9	CL31B223KBCNNN □			22nF	50	±10%	1.0
10	CL31B473KBCNNN □	47nF		50	±10%	1.0	
11	CL31B683KBCNNN □	68nF		50	±10%	1.0	
12	CL31B104KBCNNN □	100nF		50	±10%	1.0	
13	CL31B104KACNNN □	100nF		25	±10%	1.0	
14	CL31B224KBCNNN □	220nF		50	±10%	1.0	
15	CL31B224KAFNNN □	220nF		25	±10%	1.4	
16	CL31B474KBHNNN □	470nF		50	±10%	1.8	
17	CL31B474KAFNNN □	470nF		25	±10%	1.4	
18	CL31B474KOCNNN □	470nF		16	±10%	1.0	
19	CL31B684KBHNNN □	680nF		50	±10%	1.8	
20	CL31B684KAHNNN □	680nF		25	±10%	1.8	
21	CL31B105KBHNNN □	1μF		50	±10%	1.8	
22	CL31B105KAHNNN □	1μF		25	±10%	1.8	
23	CL31B105KOFNNN □	1μF		16	±10%	1.4	
24	CL31B225KBHNNN □	2.2μF		50	±10%	1.8	
25	CL31B225KAHNNN □	2.2μF		25	±10%	1.8	
26	CL31B225KOHNNN □	2.2μF		16	±10%	1.8	
27	CL31B225KPFNNN □	2.2μF		10	±10%	1.4	
1	CL32B104KBFNNN □	3.20×2.50	100nF	50	±10%	1.45	
2	CL32B224KBFNNN □		220nF	50	±10%	1.45	
3	CL32B105KBHNNN □		1μF	50	±10%	1.8	
4	CL32B105KAFNNN □		1μF	25	±10%	1.45	

※ □mark means packaging code. If you want to learn the code or quantity in detail, please see p80.

※ For parts of higher capacitance than those above listed, refer to the product lineup of 'High Capacitance' subcategory.

Product Lineup (General Capacitors-X7R)

	Part Number	Size L × W (mm)	Capacitance	Rated Voltage (Vdc)	Capacitance Tolerance	Thickness Max. (mm)
5	CL32B225KBJNNN □	3.20×2.50	2.2μF	50	±10%	2.7
6	CL32B225KAINNN □		2.2μF	25	±10%	2.2
7	CL32B474KBFNNN □		470nF	50	±10%	1.45
8	CL32B474KAFNNN □		470nF	25	±10%	1.45
9	CL32B475KOINNN □		4.7μF	16	±10%	2.2
1	CL43B224KBFNNN □	4.50×3.20	220nF	50	±10%	1.45
2	CL43B474KBFNNN □		470nF	50	±10%	1.45
3	CL43B684KBFNNN □		680nF	50	±10%	1.45
4	CL43B105KBFNNN □		1μF	50	±10%	1.45
5	CL43B106KALNNN □		10μF	25	±10%	3.5
6	CL43B226KPJNNN □		22μF	10	±10%	2.7
1	CL55B475KBJNNN □	5.70×5.00	4.7μF	50	±10%	2.7

Product Lineup (General Capacitors-X5R)

	Part Number	Size L × W (mm)	Capacitance	Rated Voltage (Vdc)	Capacitance Tolerance	Thickness Max. (mm)
1	CL05A223KO5NNN □	1.00×0.50	22nF	16	±10%	0.55
2	CL05A104KA5NNN □		100nF	25	±10%	0.55
3	CL05A104KO5NNN □		100nF	16	±10%	0.55
4	CL05A104KP5NNN □		100nF	10	±10%	0.55
5	CL05A104KQ5NNN □		100nF	6.3	±10%	0.55
6	CL05A475MO5NUN □		4.7μF	16	±20%	0.70

※ □mark means packaging code. If you want to learn the code or quantity in detail, please see p80.

※ For parts of higher capacitance than those above listed, refer to the product lineup of 'High Capacitance' subcategory.

Part Numbering System

General Capacitors

High Capacitance Capacitors

Super Small Size Capacitors

Medium-High Voltage Capacitors

Array Type Capacitors

Low ESL Capacitors

Reliability Test Condition

Premium Capacitors for Automotive Applications

Packaging Specification

Application Manual for Surface Mounting

Product Lineup (General Capacitors-Y5V)

	Part Number	Size L × W (mm)	Capacitance	Rated Voltage (Vdc)	Capacitance Tolerance	Thickness Max. (mm)
1	CL05F103ZB5NNN □	1.00×0.50	10nF	50	+80/-20%	0.55
2	CL05F103ZO5NNN □		10nF	16	+80/-20%	0.55
3	CL05F223ZA5NNN □		22nF	25	+80/-20%	0.55
4	CL05F223ZO5NNN □		22nF	16	+80/-20%	0.55
5	CL05F473ZO5NNN □		47nF	16	+80/-20%	0.55
6	CL05F683ZO5NNN □		68nF	16	+80/-20%	0.55
7	CL05F104ZO5NNN □		100nF	16	+80/-20%	0.55
1	CL10F103ZB8NNN □	1.60×0.80	10nF	50	+80/-20%	0.9
2	CL10F223ZB8NNN □		22nF	50	+80/-20%	0.9
3	CL10F473ZB8NNN □		47nF	50	+80/-20%	0.9
4	CL10F473ZA8NNN □		47nF	25	+80/-20%	0.9
5	CL10F473ZO8NNN □		47nF	16	+80/-20%	0.9
6	CL10F683ZB8NNN □		68nF	50	+80/-20%	0.9
7	CL10F104ZB8NNN □		100nF	50	+80/-20%	0.9
8	CL10F104ZA8NNN □		100nF	25	+80/-20%	0.9
9	CL10F224ZB8NNN □		220nF	50	+80/-20%	0.9
10	CL10F224ZA8NNN □		220nF	25	+80/-20%	0.9
11	CL10F225ZP8NNN □		2.2μF	10	+80/-20%	0.9
12	CL10F225ZQ8NNN □		2.2μF	6.3	+80/-20%	0.9
1	CL21F103ZBANNN □	2.00×1.25	10nF	50	+80/-20%	0.75
2	CL21F223ZBANNN □		22nF	50	+80/-20%	0.75
3	CL21F473ZBANNN □		47nF	50	+80/-20%	0.75
4	CL21F683ZBANNN □		68nF	50	+80/-20%	0.75
5	CL21F104ZBANNN □		100nF	50	+80/-20%	0.75
6	CL21F104ZBCNNN □		100nF	50	+80/-20%	0.95
7	CL21F224ZBCNNN □		220nF	50	+80/-20%	0.95
8	CL21F224ZBFNNN □		220nF	50	+80/-20%	1.35
9	CL21F224ZOANNN □		220nF	16	+80/-20%	0.75
10	CL21F474ZACNNN □		470nF	25	+80/-20%	0.95
11	CL21F474ZBFNNN □		470nF	50	+80/-20%	1.35
12	CL21F684ZAFNNN □		680nF	25	+80/-20%	1.35
13	CL21F684ZOANNN □		680nF	16	+80/-20%	0.75
14	CL21F225ZAFNNN □		2.2μF	25	+80/-20%	1.35
15	CL21F225ZOFNNN □		2.2μF	16	+80/-20%	1.35
1	CL31F103ZBCNNN □	3.20×1.60	10nF	50	+80/-20%	1.0
2	CL31F104ZBCNNN □		100nF	50	+80/-20%	1.0
3	CL31F224ZBCNNN □		220nF	50	+80/-20%	1.0
4	CL31F474ZBCNNN □		470nF	50	+80/-20%	1.0
5	CL31F105ZBFNNN □		1μF	50	+80/-20%	1.4
6	CL31F105ZAFNNN □		1μF	25	+80/-20%	1.4
7	CL31F105ZOCNNN □		1μF	16	+80/-20%	1.0
8	CL31F225ZAFNNN □		2.2μF	25	+80/-20%	1.4
9	CL31F225ZOCNNN □		2.2μF	16	+80/-20%	1.0
1	CL32F475ZAHNNN □	3.20×2.50	4.7μF	25	+80/-20%	1.8

※ □ mark means packaging code. If you want to learn the code or quantity in detail, please see p80.

※ For parts of higher capacitance than those above listed, refer to the product lineup of 'High Capacitance' subcategory.

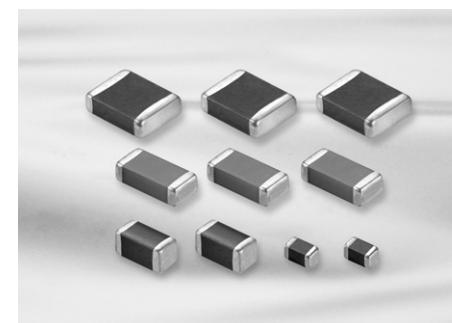

Feature

- Wide selection of size : from 0402 to 1812
- Highly reliable tolerance and high speed automatic chip placement on PCBs
- Wide capacitance range
- Highly reliable performance
- Highly resistant termination metal
- Tape & reel for surface mount assembly

Application

- Desktop PC, Note PC, HHP, DC-DC Converter, DSC
- LCD TV, LCD Monitor

Structure and Dimensions

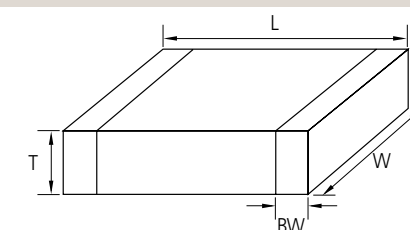

Size Code	EIA Code	Dimension(mm)				
		L	W	T	Thickness Code	BW
05	0402	1.00±0.05	0.50±0.05	0.50±0.05	5	0.25±0.10
10	0603	1.60±0.10	0.80±0.10	0.50+0.0/-0.1(*)	5	0.30±0.20
		1.60±0.10	0.80±0.10	0.80±0.10	8	
21	0805	2.00±0.10	1.25±0.10	0.85±0.10	C	0.5+0.2/-0.3
		2.00±0.10	1.25±0.10	1.15±0.10	M	
		2.00±0.10	1.25±0.10	1.25±0.10	F	
		2.00±0.15	1.25±0.15	1.25±0.15	Q	
		2.00±0.20	1.25±0.20	1.25±0.20	Y	
31	1206	3.20±0.20	1.60±0.20	0.60±0.10(*)	6	0.50±0.30
		3.20±0.15	1.60±0.15	0.85±0.15	C	
		3.20±0.20	1.60±0.20	0.85±0.10(*)	C	
		3.20±0.20	1.60±0.20	1.15±0.10(*)	P	
		3.20±0.15	1.60±0.15	1.25±0.15	F	
32	1210	3.20±0.20	1.60±0.20	1.60±0.20	H	0.60±0.30
		3.20±0.30	2.50±0.20	0.85±0.10(*)	C	
		3.20±0.30	2.50±0.20	0.90±0.10(*)	9	
		3.20±0.30	2.50±0.20	1.60±0.20	H	
		3.20±0.30	2.50±0.20	1.80±0.20(*)	U	
		3.20±0.30	2.50±0.20	2.00±0.20	I	
		3.20±0.30	2.50±0.20	2.50±0.20	J	
3.20±0.40	2.50±0.30	2.50±0.30	V			
42	1808	4.50±0.40	2.00±0.20	1.25±0.20	F	0.80±0.30
		4.50±0.40	2.00±0.20	1.40±0.20	G	
		4.50±0.40	2.00±0.20	2.00±0.20	I	
43	1812	4.50±0.40	3.20±0.30	1.25±0.20	F	0.80±0.30
		4.50±0.40	3.20±0.30	2.50±0.20	J	
		4.50±0.40	3.20±0.30	3.20±0.30	L	
55	2220	5.70±0.40	5.00±0.40	2.50±0.20	J	1.00±0.30
		5.70±0.40	5.00±0.40	3.20±0.30	L	

※ \* Mark is only applicable to "L" code , 12th code in part number.

Part Numbering System

General Capacitors

High Capacitance Capacitors

Super Small Size Capacitors

Medium-High Voltage Capacitors

Array Type Capacitors

Low ESL Capacitors

Reliability Test Condition

Premium Capacitors for Automotive Applications

Packaging Specification

Application Manual for Surface Mounting

High Capacitance Table (X5R)

Size(mm)	Vr(V)	Capacitance (μF)											
		0.1	0.22	0.47	1	2.2	4.7	10	22	47	100	220	
0402(1005)	4								15				
	6.3												
	10												
	16												
	25												
0603(1608)	4												
	6.3												
	10												
	16												
	25												
	50												
0805(2012)	4												
	6.3												
	10												
	16												
	25												
	50												
1206(3216)	6.3												
	10												
	16												
	25												
	50												
1210(3225)	6.3												
	10												
	16												
	25												

High Capacitance Table\_Low Profile (X5R)

Size(mm)	Tmax (mm)	Vr(V)	Capacitance (μF)						
			1	2.2	4.7	10	22	47	
0402(1005)	0.33	6.3	X6S						
		10							
		16							
0603(1608)	0.5	6.3							
		10							
		16							
		25							
0805(2012)	0.7	10							
		16							
		25							
	0.85	25							
		0.95	4						(Tmax=1.0)
			6.3						(Tmax=1.0)
1206(3216)	0.7	10							
		0.95	10						
			16						
	25						X6S		
	0.95	50					(Tmax=1.0)	(Tmax=1.0)	
		100					(Tmax=1.0)		
1210(3225)		0.95	16						
	2.0	25							
		35							
50									

- Part Numbering System
- General Capacitors
- High Capacitance Capacitors
- Super Small Size Capacitors
- Medium-High Voltage Capacitors
- Array Type Capacitors
- Low ESL Capacitors
- Reliability Test Condition
- Premium Capacitors for Automotive Applications
- Packaging Specification
- Application Manual for Surface Mounting

High Capacitance Table (X6S)

Size(mm)	Vr(V)	Capacitance (μF)										
		0.1	0.22	0.47	1	2.2	4.7	10	22	47	100	
0402(1005)	4	✓	✓	✓	✓	✓	✓					
	6.3	✓	✓	✓	✓	✓	✓					
	10	✓	✓	✓	✓	✓	✓					
0603(1608)	4	✓	✓	✓	✓	✓	✓	✓	✓			
	6.3	✓	✓	✓	✓	✓	✓	✓	✓			
	10	✓	✓	✓	✓	✓	✓	✓	✓			
	16	✓	✓	✓	✓	✓	✓	✓	✓	✓		
	25	✓	✓	✓	✓	✓	✓	✓	✓	✓		
0805(2012)	4	✓	✓	✓	✓	✓	✓	✓	✓	✓	✓	✓
	6.3	✓	✓	✓	✓	✓	✓	✓	✓	✓	✓	✓
	10	✓	✓	✓	✓	✓	✓	✓	✓	✓	✓	✓
	16	✓	✓	✓	✓	✓	✓	✓	✓	✓	✓	✓
	25	✓	✓	✓	✓	✓	✓	✓	✓	✓	✓	✓
1206(3216)	6.3	✓	✓	✓	✓	✓	✓	✓	✓	✓	✓	✓
	10	✓	✓	✓	✓	✓	✓	✓	✓	✓	✓	✓
	16	✓	✓	✓	✓	✓	✓	✓	✓	✓	✓	✓
	25	✓	✓	✓	✓	✓	✓	✓	✓	✓	✓	✓
1210(3225)	6.3	✓	✓	✓	✓	✓	✓	✓	✓	✓	✓	✓
	10	✓	✓	✓	✓	✓	✓	✓	✓	✓	✓	✓
	16	✓	✓	✓	✓	✓	✓	✓	✓	✓	✓	✓
	25	✓	✓	✓	✓	✓	✓	✓	✓	✓	✓	✓

High Capacitance Table (X7R)

Size(mm)	Vr(V)	Capacitance (μF)										
		0.1	0.22	0.47	1	2.2	4.7	10	22	47	100	
0402(1005)	6.3	✓	✓	✓	✓	✓	✓					
	10	✓	✓	✓	✓	✓	✓					
	16	✓	✓	✓	✓	✓	✓					
0603(1608)	6.3	✓	✓	✓	✓	✓	✓	✓	✓			
	10	✓	✓	✓	✓	✓	✓	✓	✓			
	16	✓	✓	✓	✓	✓	✓	✓	✓			
	25	✓	✓	✓	✓	✓	✓	✓	✓	✓		
	50	✓	✓	✓	✓	✓	✓	✓	✓	✓		
0805(2012)	6.3	✓	✓	✓	✓	✓	✓	✓	✓	✓	✓	✓
	10	✓	✓	✓	✓	✓	✓	✓	✓	✓	✓	✓
	16	✓	✓	✓	✓	✓	✓	✓	✓	✓	✓	✓
	25	✓	✓	✓	✓	✓	✓	✓	✓	✓	✓	✓
	35	✓	✓	✓	✓	✓	✓	✓	✓	✓	✓	✓
	50	✓	✓	✓	✓	✓	✓	✓	✓	✓	✓	✓
1206(3216)	6.3	✓	✓	✓	✓	✓	✓	✓	✓	✓	✓	✓
	10	✓	✓	✓	✓	✓	✓	✓	✓	✓	✓	✓
	16	✓	✓	✓	✓	✓	✓	✓	✓	✓	✓	✓
	25	✓	✓	✓	✓	✓	✓	✓	✓	✓	✓	✓
	50	✓	✓	✓	✓	✓	✓	✓	✓	✓	✓	✓
1210(3225)	6.3	✓	✓	✓	✓	✓	✓	✓	✓	✓	✓	✓
	10	✓	✓	✓	✓	✓	✓	✓	✓	✓	✓	✓
	16	✓	✓	✓	✓	✓	✓	✓	✓	✓	✓	✓
	25	✓	✓	✓	✓	✓	✓	✓	✓	✓	✓	✓
	50	✓	✓	✓	✓	✓	✓	✓	✓	✓	✓	✓

Part Numbering System

General Capacitors

High Capacitance Capacitors

Super Small Size Capacitors

Medium-High Voltage Capacitors

Array Type Capacitors

Low ESL Capacitors

Reliability Test Condition

Premium Capacitors for Automotive Applications

Packaging Specification

Application Manual for Surface Mounting

High Capacitance Table (Y5V)

Size(mm)	Vr(V)	Capacitance (μF)									
		0.1	0.22	0.47	1	2.2	4.7	10	22	47	
0402(1005)	6.3										
	10										
	16										
	25										
0603(1608)	6.3										
	10										
	16										
	25										
	50										
0805(2012)	6.3										
	10										
	16										
	25										
	50										
1206(3216)	10										
	16										
	25										
	50										
1210(3225)	6.3										
	10										
	16										
	25										
	35										
	50										

High Capacitance Table -Low Profile (Y5V)

Size(mm)	Vr(V)	Capacitance (μF)					
		1	2.2	4.7	10	22	47
0805(2012)	6.3						
	10						

Product Lineup (High Capacitance-X5R)

	Part Number	Size L×W (mm)	Capacitance	Rated Voltage (Vdc)	Capacitance Tolerance	Thickness Max. (mm)
1	CL05A224KQ5NNN □	1.00×0.50	0.22μF	6.3	±10%	0.55
2	CL05A224KR5NNN □		0.22μF	4	±10%	0.55
3	CL05A224KA5NNN □		0.22μF	25	±10%	0.55
4	CL05A224KO5NNN □		0.22μF	16	±10%	0.55
5	CL05A224KP5NNN □		0.22μF	10	±10%	0.55
6	CL05A334MA5NNN □		0.33μF	25	±20%	0.55
7	CL05A334KQ5NNN □		0.33μF	6.3	±10%	0.55
8	CL05A334KR5NNN □		0.33μF	4	±10%	0.55
9	CL05A474KA5NNN □		0.47μF	25	±10%	0.55
10	CL05A474KO5NNN □		0.47μF	16	±10%	0.55
11	CL05A474KP5NNN □		0.47μF	10	±10%	0.55
12	CL05A474KQ5NNN □		0.47μF	6.3	±10%	0.55
13	CL05A474KR5NNN □		0.47μF	4	±10%	0.55
14	CL05A105KA5NQN □		1μF	25	±10%	0.60
15	CL05A105KO5NNN □		1μF	16	±10%	0.55
16	CL05A105KO3LQN □		1μF	16	±10%	0.33
17	CL05A105KP5NNN □		1μF	10	±10%	0.55
18	CL05A105KP3LNN □		1μF	10	±10%	0.33
19	CL05A105KQ5NNN □		1μF	6.3	±10%	0.55
20	CL05A105KQ3LNN □		1μF	6.3	±10%	0.33
21	CL05A105KR5NNN □		1μF	4	±10%	0.55
22	CL05A105KR3LNN □		1μF	4	±10%	0.33
23	CL05A225MA5NUN □		2.2μF	25	±20%	0.70
24	CL05A225KO5NQN □		2.2μF	16	±10%	0.60
25	CL05A225MP5NSN □		2.2μF	10	±20%	0.57
26	CL05A225KP3LRN □		2.2μF	10	±10%	0.33
27	CL05A225MQ5NNN □		2.2μF	6.3	±20%	0.55
28	CL05A225KQ3LRN □		2.2μF	6.3	±10%	0.33
29	CL05A225MR5NNN □		2.2μF	4	±20%	0.55
30	CL05A225KR3LRN □		2.2μF	4	±10%	0.33
31	CL05A475MO5NUN □		4.7μF	16	±20%	0.70
32	CL05A475MP5NRN □		4.7μF	10	±20%	0.65
33	CL05A475MQ5NRN □		4.7μF	6.3	±20%	0.65
34	CL05A475MR5NRN □		4.7μF	4	±20%	0.65
35	CL05A106MP5NUN □		10μF	10	±20%	0.70
36	CL05A106MQ5NUN □		10μF	6.3	±20%	0.70
37	CL05A106MR5NRN □		10μF	4	±20%	0.65
38	CL05A156MR5NUN □		15μF	4	±20%	0.70
1	CL10A474KB8NNN □	1.60×0.80	0.47μF	50	±10%	0.90
2	CL10A474KA8NNN □		0.47μF	25	±10%	0.90
3	CL10A474KP8NNN □		0.47μF	10	±10%	0.90
4	CL10A474KQ8NNN □		0.47μF	6.3	±10%	0.90
5	CL10A474KR8NNN □		0.47μF	4	±10%	0.90
6	CL10A105KB8NNN □		1μF	50	±10%	0.90
7	CL10A105KA5LNN □		1μF	25	±10%	0.50
8	CL10A105KA8NNN □		1μF	25	±10%	0.90
9	CL10A105KO8NNN □		1μF	16	±10%	0.90
10	CL10A105KO5LNN □		1μF	16	±10%	0.50
11	CL10A105KP8NNN □		1μF	10	±10%	0.90
12	CL10A105KP5LNN □		1μF	10	±10%	0.50
13	CL10A105KQ8NNN □		1μF	6.3	±10%	0.90
14	CL10A105KQ5LNN □		1μF	6.3	±10%	0.50

※ □ mark means packaging code. If you want to learn the code or quantity in detail, please see p80.

- Part Numbering System
- General Capacitors
- High Capacitance Capacitors
- Super Small Size Capacitors
- Medium-High Voltage Capacitors
- Array Type Capacitors
- Low ESL Capacitors
- Reliability Test Condition
- Premium Capacitors for Automotive Applications
- Packaging Specification
- Application Manual for Surface Mounting

Product Lineup (High Capacitance-X5R)

	Part Number	Size L × W (mm)	Capacitance	Rated Voltage (Vdc)	Capacitance Tolerance	Thickness Max. (mm)	
15	CL10A105KR8NND □	1.60×0.80	1 μF	4	±10%	0.90	
16	CL10A105KR5LND □		1 μF	4	±10%	0.50	
17	CL10A105KA5LND □		1 μF	25	±10%	0.50	
18	CL10A225KA8NND □		2.2 μF	25	±10%	0.90	
19	CL10A225KA5LND □		2.2 μF	25	±10%	0.50	
20	CL10A225KO8NND □		2.2 μF	16	±10%	0.90	
21	CL10A225KO5LND □		2.2 μF	16	±10%	0.50	
22	CL10A225KP8NND □		2.2 μF	10	±10%	0.90	
23	CL10A225KP5LND □		2.2 μF	10	±10%	0.50	
24	CL10A225KQ8NND □		2.2 μF	6.3	±10%	0.90	
25	CL10A225KQ5LND □		2.2 μF	6.3	±10%	0.50	
26	CL10A225KR8NND □		2.2 μF	4	±10%	0.90	
27	CL10A225KR5LND □		2.2 μF	4	±10%	0.50	
28	CL10A335KQ8NND □		3.3 μF	6.3	±10%	0.90	
29	CL10A335KR8NND □		3.3 μF	4	±10%	0.90	
30	CL10A475KA8NQ □		4.7 μF	25	±10%	0.95	
31	CL10A475KO8NND □		4.7 μF	16	±10%	0.90	
32	CL10A475KP8NND □		4.7 μF	10	±10%	0.90	
33	CL10A475KP5LND □		4.7 μF	10	±10%	0.50	
34	CL10A475KQ5LND □		4.7 μF	6.3	±10%	0.50	
35	CL10A475KQ8NND □		4.7 μF	6.3	±10%	0.90	
36	CL10A475KR5LND □		4.7 μF	4	±10%	0.50	
37	CL10A475KR8NND □		4.7 μF	4	±10%	0.90	
38	CL10A106KR8NND □		10 μF	4	±10%	0.90	
39	CL10A106MR5LR □		10 μF	4	±20%	0.50	
40	CL10A106KQ8NND □		10 μF	6.3	±10%	0.90	
41	CL10A106MQ5LR □		10 μF	6.3	±20%	0.50	
42	CL10A106MP8NND □		10 μF	10	±20%	0.90	
43	CL10A106MO8NQ □		10 μF	16	±20%	0.95	
44	CL10A106MA8NR □		10 μF	25	±20%	1.00	
45	CL10A226MR8NR □		22 μF	4	±20%	1.00	
46	CL10A226MQ8NR □		22 μF	6.3	±20%	1.00	
47	CL10A226MP8NR □		22 μF	10	±20%	1.00	
48	CL10A226MP8NUN □		22 μF	10	±20%	1.05	
49	CL10A476MR8NZ □		47 μF	4	±20%	1.10	
1	CL21A105KBQND □		2.00×1.25	1 μF	50	±10%	1.40
2	CL21A105KAFND □			1 μF	25	±10%	1.35
3	CL21A105KA6LND □			1 μF	25	±10%	0.70
4	CL21A105KOFND □			1 μF	16	±10%	1.35
5	CL21A105KO6LND □			1 μF	16	±10%	0.70
6	CL21A105KQFND □			1 μF	6.3	±10%	1.35
7	CL21A105KRFND □			1 μF	4	±10%	1.35
8	CL21A225KBQND □			2.2 μF	50	±10%	1.40
9	CL21A225KAFND □			2.2 μF	25	±10%	1.35
10	CL21A225KO6LND □			2.2 μF	16	±10%	0.70
11	CL21A225KOFND □			2.2 μF	16	±10%	1.35
12	CL21A225KPFND □			2.2 μF	10	±10%	1.35
13	CL21A225KQFND □			2.2 μF	6.3	±10%	1.35
14	CL21A225KRFND □			2.2 μF	4	±10%	1.35
15	CL21A475KBQND □	4.7 μF		50	±10%	1.40	
16	CL21A475KAQND □	4.7 μF		25	±10%	1.40	
17	CL21A475KACLND □	4.7 μF		25	±10%	0.95	
18	CL21A475KOFND □	4.7 μF		16	±10%	1.35	

※ □ mark means packaging code. If you want to learn the code or quantity in detail, please see p 80.

Product Lineup (High Capacitance-X5R)

	Part Number	Size L × W (mm)	Capacitance	Rated Voltage (Vdc)	Capacitance Tolerance	Thickness Max. (mm)	
19	CL21A475KOCLND □	2.00×1.25	4.7 μF	16	±10%	0.95	
20	CL21A475KPFND □		4.7 μF	10	±10%	1.35	
21	CL21A475KPCLND □		4.7 μF	10	±10%	0.95	
22	CL21A475KQFND □		4.7 μF	6.3	±10%	1.35	
23	CL21A475KQCLND □		4.7 μF	6.3	±10%	0.95	
24	CL21A475KRFND □		4.7 μF	4	±10%	1.35	
25	CL21A475KRCLND □		4.7 μF	4	±10%	0.95	
26	CL21A106KAYND □		10 μF	25	±10%	1.45	
27	CL21A106KACLND □		10 μF	25	±10%	0.95	
28	CL21A106KA7LQ □		10 μF	25	±10%	0.80	
29	CL21A106KOFND □		10 μF	16	±10%	1.35	
30	CL21A106KQND □		10 μF	16	±10%	1.40	
31	CL21A106KOCCLND □		10 μF	16	±10%	0.95	
32	CL21A106KOCCL3R □		10 μF	16	±10%	0.95	
33	CL21A106KPFND □		10 μF	10	±10%	1.35	
34	CL21A106KPCLQ □		10 μF	10	±10%	0.95	
35	CL21A106KQFND □		10 μF	6.3	±10%	1.35	
36	CL21A106KQCLND □		10 μF	6.3	±10%	0.95	
37	CL21A106KRFND □		10 μF	4	±10%	1.35	
38	CL21A106KRCLND □		10 μF	4	±10%	0.95	
39	CL21A226MAQND □		22 μF	25	±20%	1.40	
40	CL21A226MPQND □		22 μF	10	±20%	1.40	
41	CL21A226MPCLND □		22 μF	10	±20%	0.95	
42	CL21A226MQND □		22 μF	6.3	±20%	1.40	
43	CL21A226MQCLND □		22 μF	6.3	±20%	0.95	
44	CL21A226MRQND □		22 μF	4	±20%	1.40	
45	CL21A226MRCLND □		22 μF	4	±20%	0.95	
46	CL21A336MQELND □		33 μF	6.3	±20%	1.20	
47	CL21A336MQ9LND □		33 μF	6.3	±20%	1.00	
48	CL21A336MRELND □		33 μF	4	±20%	1.20	
49	CL21A336MR9LND □		33 μF	4	±20%	1.00	
50	CL21A476MQYND □		47 μF	6.3	±20%	1.45	
51	CL21A476MRYND □		47 μF	4	±20%	1.45	
52	CL21A476MQ9LRND □		47 μF	6.3	±20%	1.00	
1	CL31A225KC9LND □		3.20×1.60	2.2 μF	100	±10%	1.00
2	CL31A475KBHND □			4.7 μF	50	±10%	1.80
3	CL31A475KB9LND □			4.7 μF	50	±10%	1.00
4	CL31A475KAHND □			4.7 μF	25	±10%	1.80
5	CL31A475KACLND □			4.7 μF	25	±10%	0.95
6	CL31A475KOHND □			4.7 μF	16	±10%	1.80
7	CL31A475KOCLND □	4.7 μF		16	±10%	0.95	
8	CL31A475KPHND □	4.7 μF		10	±10%	1.80	
9	CL31A475KQHND □	4.7 μF		6.3	±10%	1.80	
10	CL31A475KRHND □	4.7 μF		4	±10%	1.80	
11	CL31A106KBHND □	10 μF		50	±10%	1.80	
12	CL31A106KAHND □	10 μF		25	±10%	1.80	
13	CL31A106KACLND □	10 μF		25	±10%	0.95	
14	CL31A106KOHND □	10 μF		16	±10%	1.80	
15	CL31A106KOCLND □	10 μF		16	±10%	0.95	
16	CL31A106KPHND □	10 μF		10	±10%	1.80	
17	CL31A106KPCLND □	10 μF		10	±10%	0.95	
18	CL31A106KQHND □	10 μF		6.3	±10%	1.80	
19	CL31A106KRHND □	10 μF		4	±10%	1.80	
20	CL31A156KQHND □	15 μF		6.3	±10%	1.80	

※ □ mark means packaging code. If you want to learn the code or quantity in detail, please see p 80.

Part Numbering System

General Capacitors

High Capacitance Capacitors

Super Small Size Capacitors

Medium-High Voltage Capacitors

Array Type Capacitors

Low ESL Capacitors

Reliability Test Condition

Premium Capacitors for Automotive Applications

Packaging Specification

Application Manual for Surface Mounting



Product Lineup (High Capacitance-X5R)

	Part Number	Size L × W (mm)	Capacitance	Rated Voltage (Vdc)	Capacitance Tolerance	Thickness Max. (mm)
21	CL31A156KRHNND □	3.20×1.60	15μF	4	±10%	1.80
22	CL31A226KAHNND □		22μF	25	±10%	1.80
23	CL31A226KOHNNND □		22μF	16	±10%	1.80
24	CL31A226KOCNNND □		22μF	16	±10%	0.95
25	CL31A226KPHNNND □		22μF	10	±10%	1.80
26	CL31A226KPCNNND □		22μF	10	±10%	0.95
27	CL31A226KQHNNND □		22μF	6.3	±10%	1.80
28	CL31A226KRHNND □		22μF	4	±10%	1.80
29	CL31A476MQHNND □		47μF	6.3	±20%	1.80
30	CL31A476MRHNND □		47μF	4	±20%	1.80
31	CL31A107MQHNND □		100μF	6.3	±20%	1.80
32	CL31A107MRHNND □		100μF	4	±20%	1.80
33	CL31A107MPHNND □		100μF	10	±20%	1.80
1	CL32A106KQCLND □		3.20×2.50	10μF	6.3	±10%
2	CL32A106KRCLND □	10μF		4	±10%	0.95
3	CL32A106KBULND □	10μF		50	±10%	2.00
4	CL32A106KAJNND □	10μF		25	±10%	2.70
5	CL32A106KAULND □	10μF		25	±10%	2.00
6	CL32A106KOJNND □	10μF		16	±10%	2.70
7	CL32A106KPJNND □	10μF		10	±10%	2.70
8	CL32A226KAJNND □	22μF		25	±10%	2.70
9	CL32A226KOJNND □	22μF		16	±10%	2.70
10	CL32A226KOCNNND □	22μF		16	±10%	0.95
11	CL32A226KPJNND □	22μF		10	±10%	2.70
12	CL32A226KQJNND □	22μF		6.3	±10%	2.70
13	CL32A226MQCLND □	22μF		6.3	±20%	0.95
14	CL32A226KRJNND □	22μF		4	±10%	2.70
15	CL32A226MRCNNND □	22μF		4	±20%	0.95
16	CL32A476KOJNND □	47μF		16	±10%	2.70
17	CL32A476KPJNND □	47μF		10	±10%	2.70
18	CL32A476MQJNND □	47μF		6.3	±20%	2.70
19	CL32A476MRJNND □	47μF		4	±20%	2.70
20	CL32A107MPVNNND □	100μF		10	±20%	2.80
21	CL32A107MQVNNND □	100μF		6.3	±20%	2.80
22	CL32A107MRVNNND □	100μF		4	±20%	2.80
23	CL32A157MQVNNND □	150μF		6.3	±20%	2.80
24	CL32A227MQVNNND □	220μF		6.3	±20%	2.80
1	CL43A476MQJNND □	4.50×3.20	47μF	6.3	±20%	2.70
2	CL43A476MRJNND □		47μF	4	±20%	2.70
3	CL43A107KQLNND □		100μF	6.3	±10%	3.50
4	CL43A107KRLNND □		100μF	4	±10%	3.50

※ □ mark means packaging code. If you want to learn the code or quantity in detail, please see p 80.

Product Lineup (High Capacitance-X6S)

	Part Number	Size L × W (mm)	Capacitance	Rated Voltage (Vdc)	Capacitance Tolerance	Thickness Max. (mm)
1	CL05X224KP5NND □	1.00×0.50	0.22μF	10	±10%	0.55
2	CL05X224KQ5NND □		0.22μF	6.3	±10%	0.55
3	CL05X224KR5NND □		0.22μF	4	±10%	0.55
4	CL05X474KP5NND □		0.47μF	10	±10%	0.55
5	CL05X474KQ5NND □		0.47μF	6.3	±10%	0.55
6	CL05X474KR5NND □		0.47μF	4	±10%	0.55
7	CL05X105KP5NND □		1μF	10	±10%	0.55
8	CL05X105MQ3LND □		1μF	6.3	±20%	0.33
9	CL05X105KQ5NND □		1μF	6.3	±10%	0.55
10	CL05X105MR3LND □		1μF	4	±20%	0.33
11	CL05X105KR5NND □		1μF	4	±10%	0.55
12	CL05X225MQ5NSD □		2.2μF	6.3	±20%	0.57
13	CL05X225MR5NSD □		2.2μF	4	±20%	0.57
1	CL10X474KA8NND □	1.60×0.80	0.47μF	25	±10%	0.90
2	CL10X474KO8NND □		0.47μF	16	±10%	0.90
3	CL10X474KP8NND □		0.47μF	10	±10%	0.90
4	CL10X474KQ8NND □		0.47μF	6.3	±10%	0.90
5	CL10X474KR8NND □		0.47μF	4	±10%	0.90
6	CL10X105KA8NND □		1μF	25	±10%	0.90
7	CL10X105KO8NND □		1μF	16	±10%	0.90
8	CL10X105KP8NND □		1μF	10	±10%	0.90
9	CL10X105KQ8NND □		1μF	6.3	±10%	0.90
10	CL10X105KR8NND □		1μF	4	±10%	0.90
11	CL10X225KO8NND □		2.2μF	16	±10%	0.90
12	CL10X225KP8NND □		2.2μF	10	±10%	0.90
13	CL10X225KQ8NND □		2.2μF	6.3	±10%	0.90
14	CL10X225KR8NND □		2.2μF	4	±10%	0.90
15	CL10X475KA8NQD □		4.7μF	25	±10%	0.95
16	CL10X475KO8NQD □		4.7μF	16	±10%	0.95
17	CL10X475KP5NND □		4.7μF	10	±10%	0.90
18	CL10X475KQ8NND □		4.7μF	6.3	±10%	0.90
19	CL10X475KR8NND □		4.7μF	4	±10%	0.90
20	CL10X106MP8NND □		10μF	10	±20%	0.90
21	CL10X106KQ8NND □		10μF	6.3	±10%	0.90
22	CL10X106KR8NND □		10μF	4	±10%	0.90
1	CL21X105KAFNND □	2.00×1.25	1μF	25	±10%	1.35
2	CL21X105KOFNND □		1μF	16	±10%	1.35
3	CL21X105KPFNND □		1μF	10	±10%	1.35
4	CL21X105KQFNND □		1μF	6.3	±10%	1.35
5	CL21X105KRFNND □		1μF	4	±10%	1.35
6	CL21X225KAFNND □		2.2μF	25	±10%	1.35
7	CL21X225KOFNND □		2.2μF	16	±10%	1.35
8	CL21X225KPFNND □		2.2μF	10	±10%	1.35
9	CL21X225KQFNND □		2.2μF	6.3	±10%	1.35
10	CL21X225KRFNND □		2.2μF	4	±10%	1.35
11	CL21X475KAQNNND □		4.7μF	25	±10%	1.40
12	CL21X475KOFNND □		4.7μF	16	±10%	1.35
13	CL21X475KPFNND □		4.7μF	10	±10%	1.35
14	CL21X475KQFNND □		4.7μF	6.3	±10%	1.35

※ □ mark means packaging code. If you want to learn the code or quantity in detail, please see p 80.

- Part Numbering System
- General Capacitors
- High Capacitance Capacitors
- Super Small Size Capacitors
- Medium-High Voltage Capacitors
- Array Type Capacitors
- Low ESL Capacitors
- Reliability Test Condition
- Premium Capacitors for Automotive Applications
- Packaging Specification
- Application Manual for Surface Mounting

Product Lineup (High Capacitance -X6S)

	Part Number	Size L × W (mm)	Capacitance	Rated Voltage (Vdc)	Capacitance Tolerance	Thickness Max. (mm)	
15	CL21X475KRFNNN □	2.00×1.25	4.7μF	4	±10%	1.35	
16	CL21X106KACLRN □		10μF	25	±10%	0.95	
17	CL21X106KAYNNN □		10μF	25	±10%	1.45	
18	CL21X106KOYNNN □		10μF	16	±10%	1.45	
19	CL21X106KPCLNN □		10μF	10	±10%	0.95	
20	CL21X106KPYNNN □		10μF	10	±10%	1.45	
21	CL21X106KQNNN □		10μF	6.3	±10%	1.40	
22	CL21X106KRQNNN □		10μF	4	±10%	1.40	
23	CL21X106KRCLNN □		10μF	4	±10%	0.95	
24	CL21X226MQNNN □		22μF	6.3	±20%	1.40	
25	CL21X226MRQNNN □		22μF	4	±20%	1.40	
26	CL21X476MRYNNN □		47μF	4	±20%	1.45	
1	CL31X475KAHNNN □		3.20×1.60	4.7μF	25	±10%	1.80
2	CL31X475KACLNN □			4.7μF	25	±10%	0.95
3	CL31X475KOHNNN □	4.7μF		16	±10%	1.80	
4	CL31X475KPHNNN □	4.7μF		10	±10%	1.80	
5	CL31X475MQHNNN □	4.7μF		6.3	±20%	1.80	
6	CL31X475KRHNNN □	4.7μF		4	±10%	1.80	
7	CL31X106KACLNN □	10μF		25	±10%	0.95	
8	CL31X106KAHNNN □	10μF		25	±10%	1.80	
9	CL31X106KOHNNN □	10μF		16	±10%	1.80	
10	CL31X106KPHNNN □	10μF		10	±10%	1.80	
11	CL31X106KQHNNN □	10μF		6.3	±10%	1.80	
12	CL31X106KRHNNN □	10μF		4	±10%	1.80	
13	CL31X226KOHNNN □	22μF		16	±10%	1.80	
14	CL31X226KPHNNN □	22μF		10	±10%	1.80	
15	CL31X226KQHNNN □	22μF		6.3	±10%	1.80	
16	CL31X226KRHNNN □	22μF		4	±10%	1.80	
17	CL31X107MQHNNN □	100μF		6.3	±20%	1.80	
18	CL31X107MRHNNN □	100μF		4	±20%	1.80	
1	CL32X106KAUNNN □	3.20×2.50	10μF	25	±10%	2.00	
2	CL32X106KOJNNN □		10μF	16	±10%	2.70	
3	CL32X106KPJNNN □		10μF	10	±10%	2.70	
4	CL32X106KQJNNN □		10μF	6.3	±10%	2.70	
5	CL32X106KRJNNN □		10μF	4	±10%	2.70	
6	CL32X226KAJNNN □		22μF	25	±10%	2.70	
7	CL32X226KOJNNN □		22μF	16	±10%	2.70	
8	CL32X226KPJNNN □		22μF	10	±10%	2.70	
9	CL32X226KQJNNN □		22μF	6.3	±10%	2.70	
10	CL32X226KRJNNN □		22μF	4	±10%	2.70	
11	CL32X476MPJNNN □		47μF	10	±20%	2.70	
12	CL32X476KQJNNN □		47μF	6.3	±10%	2.70	
13	CL32X476KRJNNN □		47μF	4	±10%	2.70	
14	CL32X107MQVNNN □		100μF	6.3	±20%	2.80	
15	CL32X107MRVNNN □		100μF	4	±20%	2.80	

※ □mark means packaging code. If you want to learn the code or quantity in detail, please see p80.

Product Lineup (High Capacitance -X7R, X7S)

	Part Number	Size L × W (mm)	Capacitance	Rated Voltage (Vdc)	Capacitance Tolerance	Thickness Max. (mm)
1	CL05B224KO5NNN □	1.00×0.50	0.22μF	16	±10%	0.55
2	CL05B224KP5NNN □		0.22μF	10	±10%	0.55
3	CL05B224KQ5NNN □		0.22μF	6.3	±10%	0.55
4	CL05B474KP5NNN □		0.47μF	10	±10%	0.55
5	CL05B105KQ5NQN □		1μF	6.3	±10%	0.60
1	CL05Y474KP5NNN □	1.00×0.50	0.47μF	10	±10%	0.55
1	CL10B474KA8NNN □	1.60×0.80	0.47μF	25	±10%	0.90
2	CL10B474KO8NNN □		0.47μF	16	±10%	0.90
3	CL10B474KP8NNN □		0.47μF	10	±10%	0.90
4	CL10B474KQ8NNN □		0.47μF	6.3	±10%	0.90
5	CL10B105KA8NNN □		1μF	25	±10%	0.90
6	CL10B105KO8NNN □		1μF	16	±10%	0.90
7	CL10B105KP8NNN □		1μF	10	±10%	0.90
8	CL10B105KQ8NNN □		1μF	6.3	±10%	0.90
9	CL10B225KP8NNN □		2.2μF	10	±10%	0.90
10	CL10B225KQ8NNN □		2.2μF	6.3	±10%	0.90
11	CL10B106MQ8NRR □		10μF	6.3	±20%	1.00
1	CL21B105KBFNNN □	2.00×1.25	1μF	50	±10%	1.35
2	CL21B105KLFNNN □		1μF	35	±10%	1.35
3	CL21B105KAFNNN □		1μF	25	±10%	1.35
4	CL21B105KOFNNN □		1μF	16	±10%	1.35
5	CL21B105KPFNNN □		1μF	10	±10%	1.35
6	CL21B105KQFNNN □		1μF	6.3	±10%	1.35
7	CL21B225KAFNNN □		2.2μF	25	±10%	1.35
8	CL21B225KOFNNN □		2.2μF	16	±10%	1.35
9	CL21B225KPFNNN □		2.2μF	10	±10%	1.35
10	CL21B225KQFNNN □		2.2μF	6.3	±10%	1.35
11	CL21B475KOFNFN □		4.7μF	16	±10%	1.35
12	CL21B475KPFNNN □		4.7μF	10	±10%	1.35
13	CL21B475KQNNN □		4.7μF	6.3	±10%	1.40
14	CL21B106KAYNNN □		10μF	25	±10%	1.45
15	CL21B106KQNNN □		10μF	16	±10%	1.40
16	CL21B106KPQNNN □		10μF	10	±10%	1.40
17	CL21B106KQNNN □		10μF	6.3	±10%	1.40
18	CL21B226MQNNN □		22μF	6.3	±20%	1.40
1	CL31B475KBHNNN □	3.20×1.60	4.7μF	50	±10%	1.80
2	CL31B475KLHNNN □		4.7μF	35	±10%	1.80
3	CL31B475KAHNNN □		4.7μF	25	±10%	1.80
4	CL31B475KOHNNN □		4.7μF	16	±10%	1.80
5	CL31B475KPHNNN □		4.7μF	10	±10%	1.80
6	CL31B106KBHNSN □		4.7μF	6.3	±10%	1.80
7	CL31B106KLHNNN □		10μF	35	±10%	1.80
8	CL31B106KAHNNN □		10μF	25	±10%	1.80
9	CL31B106KOHNNN □		10μF	16	±10%	1.80
10	CL31B106KPHNNN □		10μF	10	±10%	1.80
11	CL31B106KQHNNN □		10μF	6.3	±10%	1.80
12	CL31B226KPHNNN □		22μF	10	±10%	1.80
1	CL32B106KBJNNN □	3.20×2.50	10μF	50	±10%	2.70
2	CL32B106KAJNNN □		10μF	25	±10%	2.70
3	CL32B106KOJNNN □		10μF	16	±10%	2.70
4	CL32B106KPIJNNN □		10μF	10	±10%	2.20
5	CL32B106KQJNNN □		10μF	6.3	±10%	2.70
6	CL32B226KAJNNN □		22μF	25	±10%	2.70
7	CL32B226KOJNNN □		22μF	16	±10%	2.70
8	CL32B226KPIJNNN □		22μF	10	±10%	2.70
9	CL32B226KQJNNN □		22μF	6.3	±10%	2.70
10	CL32B476MQJNNN □		47μF	6.3	±20%	2.70
11	CL32B476MPJNNN □		47μF	10	±20%	2.70

※ □mark means packaging code. If you want to learn the code or quantity in detail, please see p80.

Part Numbering System

General Capacitors

High Capacitance Capacitors

Super Small Size Capacitors

Medium-High Voltage Capacitors

Array Type Capacitors

Low ESL Capacitors

Reliability Test Condition

Premium Capacitors for Automotive Applications

Packaging Specification

Application Manual for Surface Mounting

Product Lineup (High Capacitance -Y5V)

	Part Number	Size L × W (mm)	Capacitance	Rated Voltage (Vdc)	Capacitance Tolerance	Thickness Max. (mm)
1	CL05F224ZO5NNN □	1.00×0.50	0.22μF	16	+80/-20%	0.55
2	CL05F224ZP5NNN □		0.22μF	10	+80/-20%	0.55
3	CL05F224ZQ5NNN □		0.22μF	6.3	+80/-20%	0.55
4	CL05F474ZP5NNN □		0.47μF	10	+80/-20%	0.55
5	CL05F474ZQ5NNN □		0.47μF	6.3	+80/-20%	0.55
6	CL05F105ZQ5NNN □		1μF	6.3	+80/-20%	0.55
1	CL10F474ZB8NNN □	1.60×0.80	0.47μF	50	+80/-20%	0.90
2	CL10F474ZA8NNN □		0.47μF	25	+80/-20%	0.90
3	CL10F474ZO8NNN □		0.47μF	16	+80/-20%	0.90
4	CL10F474ZP8NNN □		0.47μF	10	+80/-20%	0.90
5	CL10F105ZO8NNN □		1μF	16	+80/-20%	0.90
6	CL10F105ZP8NNN □		1μF	10	+80/-20%	0.90
7	CL10F225ZP8NNN □		2.2μF	10	+80/-20%	0.90
8	CL10F225ZQ8NNN □		2.2μF	6.3	+80/-20%	0.90
9	CL10F475ZQ8NNN □		4.7μF	6.3	+80/-20%	0.90
1	CL21F105ZBFNNN □	2.00×1.25	1μF	50	+80/-20%	1.35
2	CL21F105ZAFNNN □		1μF	25	+80/-20%	1.35
3	CL21F105ZOFNNN □		1μF	16	+80/-20%	1.35
4	CL21F225ZAFNNN □		2.2μF	25	+80/-20%	1.35
5	CL21F225ZOFNNN □		2.2μF	16	+80/-20%	1.35
6	CL21F475ZQFNNN □		4.7μF	6.3	+80/-20%	1.35
7	CL21F475ZOFNNN □		4.7μF	16	+80/-20%	1.35
8	CL21F475ZPFNNN □		4.7μF	10	+80/-20%	1.35
9	CL21F106ZPFNNN □		10μF	10	+80/-20%	1.35
10	CL21F106ZPCLNN □		10μF	10	+80/-20%	0.95
11	CL21F106ZQFNNN □		10μF	6.3	+80/-20%	1.35
12	CL21F106ZQLNN □		10μF	6.3	+80/-20%	0.95
1	CL31F475ZOFNNN □	3.20×1.60	4.7μF	16	+80/-20%	1.40
2	CL31F475ZPFNNN □		4.7μF	10	+80/-20%	1.40
3	CL31F475ZQFNNN □		4.7μF	6.3	+80/-20%	1.40
4	CL31F106ZOHNNN □		10μF	16	+80/-20%	1.80
5	CL31F106ZPHNNN □		10μF	10	+80/-20%	1.80
6	CL31F106ZQHNNN □		10μF	6.3	+80/-20%	1.80
7	CL31F226ZPHNNN □		22μF	10	+80/-20%	1.80
8	CL31F226ZQHNNN □		22μF	6.3	+80/-20%	1.80
1	CL32F106ZAHNNN □	3.20×2.50	10μF	25	+80/-20%	1.80
2	CL32F106ZOELNN □		10μF	16	+80/-20%	1.20
3	CL32F226ZPJNNN □		22μF	10	+80/-20%	2.70
4	CL32F226ZPJLNN □		22μF	10	+80/-20%	2.70
5	CL32F476ZQINNN □		47μF	6.3	+80/-20%	2.20
6	CL32F107ZQJNNN □		100μF	6.3	+80/-20%	2.70

※ □ mark means packaging code. If you want to learn the code or quantity in detail, please see p80.

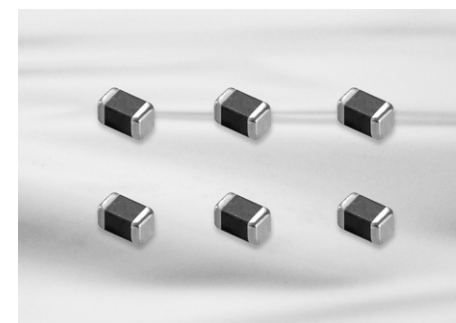

Feature

- Small chip size
- 03 Series(COG) MLCC shows very low ESR value.
- 02 and 03 Series are suited to only reflow soldering
- 02 and 03 Series are suited to miniature RF module, portable equipment and high frequency circuit

Application

- VCO, Tuner, RF Module
- MCM Module
- Mobile phone, Wireless LAN, Note PC

Structure and Dimensions

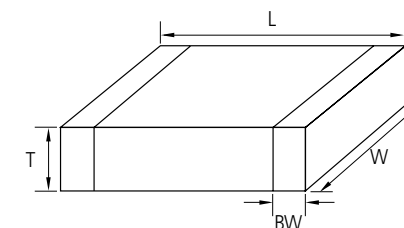

Code	EIA Code	Dimension(mm)			
		L	W	T	BW
02	01005	0.4±0.02	0.2±0.02	0.2±0.02	0.07~0.14
03	0201	0.6±0.03	0.3±0.03	0.3±0.03	0.15±0.05

Part Numbering System

General Capacitors

High Capacitance Capacitors

Super Small Size Capacitors

Medium-High Voltage Capacitors

Array Type Capacitors

Low ESL Capacitors

Reliability Test Condition

Premium Capacitors for Automotive Applications

Packaging Specification

Application Manual for Surface Mounting

Super Small Size Capacitance Table (C0G)

TC	Size (mm)	Vr(V)	Capacitance (pF)							
			0.5	1	10	22	47	100	220	330
C0G	01005(0402)	6.3								
		16								
	0201(0603)	25								
		50								

Super Small Size Capacitance Table (X7R,X6S)

TC	Size (mm)	Vr(V)	Capacitance (nF)							
			0.1	0.22	0.47	1	2.2	3.3	4.7	10
X7R	01005(0402)	10								
		16								
	0201(0603)	10								
		16								
		25								
X6S	0201(0603)	4								

Super Small Size Capacitance Table (X5R, Y5V)

TC	Size (mm)	Vr(V)	Capacitance (μF)							
			0.01	0.1	0.22	0.47	1	2.2	4.7	10
X5R	01005(0402)	6.3								
		10								
		16								
	0201(0603)	4		X5R or X6S						
		6.3								
		10								
		16								
25										
Y5V	0201(0603)	6.3								

Product Lineup (Super Small Size Capacitors -C0G)

	Part Number	Size L×W (mm)	Capacitance	Rated Voltage (Vdc)	Capacitance Tolerance	Thickness Max. (mm)	
1	CL02C0R5CO2ANN □	0.40×0.20	0.5pF	16	±0.25pF	0.22	
2	CL02C010CO2ANN □		1.0pF	16	±0.25pF	0.22	
3	CL02C1R2CO2ANN □		1.2pF	16	±0.25pF	0.22	
4	CL02C1R5CO2ANN □		1.5pF	16	±0.25pF	0.22	
5	CL02C1R8CO2ANN □		1.8pF	16	±0.25pF	0.22	
6	CL02C020CO2ANN □		2.0pF	16	±0.25pF	0.22	
7	CL02C2R2CO2ANN □		2.2pF	16	±0.25pF	0.22	
8	CL02C2R7CO2ANN □		2.7pF	16	±0.25pF	0.22	
9	CL02C030CO2ANN □		3.0pF	16	±0.25pF	0.22	
10	CL02C3R3CO2ANN □		3.3pF	16	±0.25pF	0.22	
11	CL02C3R9CO2ANN □		3.9pF	16	±0.25pF	0.22	
12	CL02C4R7CO2ANN □		4.7pF	16	±0.25pF	0.22	
13	CL02C5R6DO2ANN □		5.6pF	16	±0.5pF	0.22	
14	CL02C6R8DO2ANN □		6.8pF	16	±0.5pF	0.22	
15	CL02C8R2DO2ANN □		8.2pF	16	±0.5pF	0.22	
16	CL02C090DO2ANN □		9.0pF	16	±0.5pF	0.22	
17	CL02C100JO2ANN □		10pF	16	±5%	0.22	
18	CL02C150JO2ANN □		15pF	16	±5%	0.22	
19	CL02C180JO2ANN □		18pF	16	±5%	0.22	
20	CL02C220JO2ANN □		22pF	16	±5%	0.22	
21	CL02C270JO2ANN □		27pF	16	±5%	0.22	
22	CL02C330JO2ANN □		33pF	16	±5%	0.22	
23	CL02C390JO2ANN □		39pF	16	±5%	0.22	
24	CL02C470JO2ANN □		47pF	16	±5%	0.22	
25	CL02C560JQ2ANN □		56pF	6.3	±5%	0.22	
26	CL02C680JQ2ANN □		68pF	6.3	±5%	0.22	
27	CL02C820JQ2ANN □		82pF	6.3	±5%	0.22	
28	CL02C101JO2ANN □		100pF	16	±5%	0.22	
29	CL02C101JQ2ANN □		100pF	6.3	±5%	0.22	
1	CL03C0R5CA3GNN □	0.60×0.30	0.5pF	25	±0.25pF	0.33	High-Q
2	CL03C010CA3GNN □		1.0pF	25	±0.25pF	0.33	High-Q
3	CL03C1R2CA3GNN □		1.2pF	25	±0.25pF	0.33	High-Q
4	CL03C1R5CA3GNN □		1.5pF	25	±0.25pF	0.33	High-Q
5	CL03C1R8CA3GNN □		1.8pF	25	±0.25pF	0.33	High-Q
6	CL03C020CA3GNN □		2.0pF	25	±0.25pF	0.33	High-Q
7	CL03C2R2CA3GNN □		2.2pF	25	±0.25pF	0.33	High-Q
8	CL03C2R7CA3GNN □		2.7pF	25	±0.25pF	0.33	High-Q
9	CL03C030CA3GNN □		3.0pF	25	±0.25pF	0.33	High-Q
10	CL03C3R3CA3GNN □		3.3pF	25	±0.25pF	0.33	High-Q
11	CL03C3R9CA3GNN □		3.9pF	25	±0.25pF	0.33	High-Q
12	CL03C4R7CA3GNN □		4.7pF	25	±0.25pF	0.33	High-Q
13	CL03C5R6DA3GNN □		5.6pF	25	±0.5pF	0.33	High-Q
14	CL03C6R8DA3GNN □		6.8pF	25	±0.5pF	0.33	High-Q
15	CL03C8R2DA3GNN □		8.2pF	25	±0.5pF	0.33	High-Q
16	CL03C090DA3GNN □		9.0pF	25	±0.5pF	0.33	High-Q
17	CL03C100JA3GNN □		10pF	25	±5%	0.33	High-Q
18	CL03C150JA3ANN □		15pF	25	±5%	0.33	
19	CL03C180JA3ANN □		18pF	25	±5%	0.33	
20	CL03C220JA3ANN □		22pF	25	±5%	0.33	
21	CL03C270JA3ANN □		27pF	25	±5%	0.33	
22	CL03C330JA3ANN □		33pF	25	±5%	0.33	
23	CL03C390JA3ANN □		39pF	25	±5%	0.33	
24	CL03C470JA3ANN □		47pF	25	±5%	0.33	
25	CL03C101JB3ANN □		100pF	50	±5%	0.33	
26	CL03C101JA3ANN □		100pF	25	±5%	0.33	

Part Numbering System

General Capacitors

High Capacitance Capacitors

Super Small Size Capacitors

Medium-High Voltage Capacitors

Array Type Capacitors

Low ESL Capacitors

Reliability Test Condition

Premium Capacitors for Automotive Applications

Packaging Specification

Application Manual for Surface Mounting

※ □ mark means packaging code. If you want to learn the code or quantity in detail, please see p80.

Product Lineup (Super Small Size Capacitors -X7R,X6S)

	Part Number	Size L × W (mm)	Capacitance	Rated Voltage (Vdc)	Capacitance Tolerance	Thickness Max. (mm)
1	CL02B101KP2NNN □	0.40×0.20	100pF	10	±10%	0.22
2	CL02B151KP2NNN □		150pF	10	±10%	0.22
3	CL02B221KP2NNN □		220pF	10	±10%	0.22
4	CL02B331KP2NNN □		330pF	10	±10%	0.22
5	CL02B471KP2NNN □		470pF	10	±10%	0.22
6	CL02B681KP2NNN □		680pF	10	±10%	0.22
7	CL02B102KP2NNN □		1nF	10	±10%	0.22
1	CL03B331K03NNN □	0.60×0.30	330pF	16	±10%	0.33
2	CL03B102KB3NNN □		1nF	50	±10%	0.33
3	CL03B102K03NNN □		1nF	16	±10%	0.33
4	CL03B332K03NNN □		3.3nF	16	±10%	0.33
5	CL03B472KQ3NNN □		4.7nF	6.3	±10%	0.33
6	CL03B103KP3NNN □		10nF	10	±10%	0.33
7	CL03X104KR3NNN □		100nF	4	±10%	0.33

Product Lineup (Super Small Size Capacitors -X5R)

	Part Number	Size L × W (mm)	Capacitance	Rated Voltage (Vdc)	Capacitance Tolerance	Thickness Max. (mm)
1	CL02A151KQ2NNN □	0.40×0.20	150pF	6.3	±10%	0.22
2	CL02A221KQ2NNN □		220pF	6.3	±10%	0.22
3	CL02A331KQ2NNN □		330pF	6.3	±10%	0.22
4	CL02A471KQ2NNN □		470pF	6.3	±10%	0.22
5	CL02A681KQ2NNN □		680pF	6.3	±10%	0.22
6	CL02A102KQ2NNN □		1nF	6.3	±10%	0.22
7	CL02A152KQ2NNN □		1.5nF	6.3	±10%	0.22
8	CL02A222KQ2NNN □		2.2nF	6.3	±10%	0.22
9	CL02A332KQ2NNN □		3.2nF	6.3	±10%	0.22
10	CL02A472KQ2NNN □		4.7nF	6.3	±10%	0.22
11	CL02A682KQ2NNN □		6.8nF	6.3	±10%	0.22
12	CL02A103KQ2NNN □		10nF	6.3	±10%	0.22
13	CL02A104KQ2NNN □		100nF	6.3	±10%	0.22
14	CL02A224MR2NNN □		220nF	4	±20%	0.22
15	CL02A224MQ2NNN □		220nF	6.3	±20%	0.22
1	CL03A103KP3NNN □	0.60×0.30	10nF	10	±10%	0.33
2	CL03A223KQ3NNN □		22nF	6.3	±10%	0.33
3	CL03A473KQ3NNN □		47nF	6.3	±10%	0.33
4	CL03A104MA3NNN □		100nF	25	±20%	0.33
5	CL03A104K03NNN □		100nF	16	±10%	0.33
6	CL03A104KP3NNN □		100nF	10	±10%	0.33
7	CL03A104KQ3NNN □		100nF	6.3	±10%	0.33
8	CL03A224KQ3NNN □		220nF	6.3	±10%	0.33
9	CL03A224KP3NNN □		220nF	10	±10%	0.33
10	CL03A105MO3NRN □		1nF	16	±20%	0.39
11	CL03A105MQ3CSN □		1μF	6.3	±20%	0.35
12	CL03A105MP3NSN □		1μF	10	±20%	0.35
13	CL03A225MR3CRN □		2.2μF	4	±20%	0.39
14	CL03A225MQ3CRN □		2.2μF	6.3	±20%	0.39

※ □mark means packaging code. If you want to learn the code or quantity in detail, please see p80.

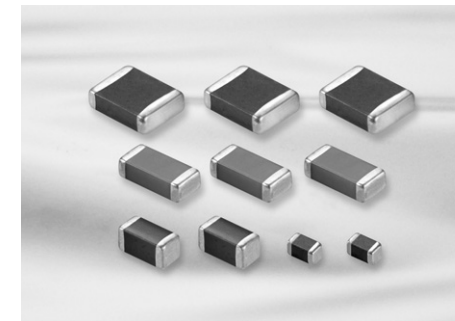

Feature

- Highly reliable performance
- Operating at high voltage level
- Wide voltage level: from 100V to 3000V
- High withstanding voltage
- Tape & reel surface mount assembly

Application

- Switching Power Circuit(SMPS)
- Lighting Ballast, LCD back lighting inverter
- DC-DC converter input filter, snubber circuit
- Phone, Fax, Modem
- Network(IEEE802.3)

Structure and Dimensions

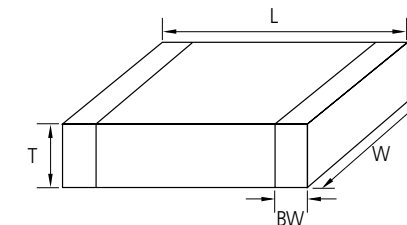

Code	EIA Code	Dimension(mm)				
		L	W	T	Thickness Code	BW
10	0603	1.60±0.10	0.80±0.10	0.80±0.10	8	0.3±0.2
21	0805	2.00±0.10	1.25±0.10	1.25±0.10	F	0.5+0.2/-0.3
		2.00±0.10	1.25±0.10	0.65±0.10	A	
31	1206	3.20±0.20	1.60±0.20	1.60±0.20	H	0.5±0.3
		3.20±0.15	1.60±0.15	0.85±0.15	C	
32	1210	3.20±0.30	2.50±0.20	2.50±0.20	J	0.6±0.3
		3.20±0.30	2.50±0.20	1.25±0.20	F	
42	1808	4.50±0.40	2.00±0.20	2.00±0.20	I	0.8±0.3
		4.50±0.40	2.00±0.20	1.60±0.20	H	
43	1812	4.50±0.40	2.00±0.20	1.25±0.20	F	0.8±0.3
		4.50±0.40	3.20±0.30	2.50±0.20	J	
55	2220	5.70±0.40	5.00±0.40	2.50±0.20	J	1.0±0.3
		5.70±0.40	5.00±0.40	1.60±0.20	H	

Part Numbering System

General Capacitors

High Capacitance Capacitors

Super Small Size Capacitors

Medium-High Voltage Capacitors

Array Type Capacitors

Low ESL Capacitors

Reliability Test Condition

Premium Capacitors for Automotive Applications

Packaging Specification

Application Manual for Surface Mounting

Medium-High Voltage Capacitors Table (COG)

Vr	Size(mm)	Capacitance																									
		(pF)						(nF)																			
		330	390	470	560	680	820	1	1.2	1.5	1.8	2.2	2.7	3.3	3.9	4.7	5.6	6.8	8.2	10	12	15	18	22	27	33	47
100V	0603(1608)	■																									
	0805(2012)	■																									
	1206(3216)	■																									
	1210(3225)							■																			
	1812(4532)							■																			
	2220(5750)							■																			
200V	0603(1608)	■																									
	0805(2012)	■																									
	1206(3216)	■																									
	1210(3225)							■																			
	1812(4532)							■																			
	2220(5750)							■																			
250V	0603(1608)	■																									
	0805(2012)	■																									
	1206(3216)	■																									
	1210(3225)							■																			
	1812(4532)							■																			
	2220(5750)							■																			
500V	1206(3216)	■																									
	1210(3225)							■																			
	1812(4532)							■																			
	2220(5750)							■																			
630V	0805(2012)	■																									
	1206(3216)	■																									
	1210(3225)							■																			
	1812(4532)							■																			
	2220(5750)							■																			

Medium-High Voltage Capacitors Table (COG)

Vr	Size(mm)	Capacitance																							
		(pF)												(nF)											
		47	56	68	82	100	120	150	180	220	270	330	390	470	560	680	820	1	1.2	1.5	1.8	2.2	2.7	3.3	3.9
1KV	1206(3216)	■																							
	1210(3225)													■											
	1812(4532)													■											
	2220(5750)													■											
2KV	1206(3216)	■																							
	1210(3225)	■																							
	1808(4520)	■																							
	1812(4532)	■																							
3KV	2220(5750)													■											
	1808(4520)	■																							
	1812(4532)	■																							

Part Numbering System

General Capacitors

High Capacitance Capacitors

Super Small Size Capacitors

Medium-High Voltage Capacitors

Array Type Capacitors

Low ESL Capacitors

Reliability Test Condition

Premium Capacitors for Automotive Applications

Packaging Specification

Application Manual for Surface Mounting

Medium-High Voltage Capacitors Table (X7R)

Vr(V)	Size(mm)	Capacitance (nF)															
		4.7	10	15	22	33	47	68	100	150	220	330	470	680	1000	1500	2200
100V	0603(1608)	[Shaded]															
	0805(2012)	[Shaded]															
	1206(3216)	[Shaded]															
	1210(3225)	[Shaded]															
	1812(4532)	[Shaded]															
	2220(5750)	[Shaded]															
200V	0805(2012)	[Shaded]															
	1206(3216)	[Shaded]															
	1210(3225)	[Shaded]															
	1812(4532)	[Shaded]															
	2220(5750)	[Shaded]															
250V	0805(2012)	[Shaded]															
	1206(3216)	[Shaded]															
	1210(3225)	[Shaded]															
	1812(4532)	[Shaded]															
	2220(5750)	[Shaded]															
350V	1206(3216)	[Shaded] (Tmax=1.0) (Tmax=1.25) (Tmax=1.8)															
500V	1206(3216)	[Shaded]															
	1210(3225)	[Shaded]															
	1812(4532)	[Shaded]															
	2220(5750)	[Shaded]															
630V	1206(3216)	[Shaded]															
	1210(3225)	[Shaded]															
	1812(4532)	[Shaded]															
	2220(5750)	[Shaded]															

Medium-High Voltage Capacitors Table (X7R)

Vr(V)	Size(mm)	Capacitance (nF)													
		1	1.5	2.2	3.3	4.7	6.8	10	15	22	33	47	68	100	150
1KV	1206(3216)	[Shaded]													
	1210(3225)	[Shaded]													
	1812(4532)	[Shaded]													
	2220(5750)	[Shaded]													
2KV	1206(3216)	[Shaded]													
	1210(3225)	[Shaded]													
	1808(4520)	[Shaded]													
	1812(4532)	[Shaded]													
3KV	1808(4520)	[Shaded]													

- Part Numbering System
- General Capacitors
- High Capacitance Capacitors
- Super Small Size Capacitors
- Medium-High Voltage Capacitors
- Array Type Capacitors
- Low ESL Capacitors
- Reliability Test Condition
- Premium Capacitors for Automotive Applications
- Packaging Specification
- Application Manual for Surface Mounting

Product Lineup (Medium-High Voltage Capacitors-C0G)

	Part Number	Size L × W (mm)	Capacitance	Rated Voltage (Vdc)	Capacitance Tolerance	Thickness Max. (mm)
1	CL10C100JC8NNN □	1.60×0.80	10pF	100	±5%	0.90
2	CL10C150JC8NNN □		15pF	100	±5%	0.90
3	CL10C330JC8NNN □		33pF	100	±5%	0.90
4	CL10C390JC8NNN □		39pF	100	±5%	0.90
5	CL10C470JC8NNN □		47pF	100	±5%	0.90
6	CL10C560JC8NNN □		56pF	100	±5%	0.90
7	CL10C101JC8NNN □		100pF	100	±5%	0.90
8	CL10C121JC8NNN □		120pF	100	±5%	0.90
9	CL10C151JC8NNN □		150pF	100	±5%	0.90
10	CL10C331JC8NNN □		330pF	100	±5%	0.90
11	CL10C331JD8NNN □		330pF	200	±5%	0.90
12	CL10C331JE8NNN □		330pF	250	±5%	0.90
13	CL10C391JD8NNN □		390pF	200	±5%	0.90
14	CL10C391JE8NNN □		390pF	250	±5%	0.90
15	CL10C471JC8NNN □		470pF	100	±5%	0.90
16	CL10C471JD8NNN □		470pF	200	±5%	0.90
17	CL10C471JE8NNN □		470pF	250	±5%	0.90
18	CL10C561JD8NNN □		560pF	200	±5%	0.90
19	CL10C561JE8NNN □		560pF	250	±5%	0.90
20	CL10C681JC8NNN □		680pF	100	±5%	0.90
21	CL10C681JD8NNN □		680pF	200	±5%	0.90
22	CL10C681JE8NNN □		680pF	250	±5%	0.90
23	CL10C821JC8NNN □		820pF	100	±5%	0.90
24	CL10C102JC8NNN □		1nF	100	±5%	0.90
25	CL10C122JC8NNN □		1.2nF	100	±5%	0.90
1	CL21C100JCANNN □	2.00×1.25	10pF	100	±5%	0.75
2	CL21C120JCANNN □		12pF	100	±5%	0.75
3	CL21C150JCANNN □		15pF	100	±5%	0.75
4	CL21C150JDCNNN □		15pF	200	±5%	0.95
5	CL21C180JCANNN □		18pF	100	±5%	0.75
6	CL21C180JDCNNN □		18pF	200	±5%	0.95
7	CL21C220JCANNN □		22pF	100	±5%	0.75
8	CL21C270JCANNN □		27pF	100	±5%	0.75
9	CL21C270JHFNNN □		27pF	630	±5%	1.35
10	CL21C330JCANNN □		33pF	100	±5%	0.75
11	CL21C330JDCNNN □		33pF	200	±5%	0.95
12	CL21C330JHFNNN □		33pF	630	±5%	1.35
13	CL21C390JDCNNN □		39pF	200	±5%	0.95
14	CL21C470JCANNN □		47pF	100	±5%	0.75
15	CL21C470JDCNNN □		47pF	200	±5%	0.95
16	CL21C470JHFNNN □		47pF	630	±5%	1.35
17	CL21C560JCCNNN □		56pF	100	±5%	0.95
18	CL21C560JDCNNN □		56pF	200	±5%	0.95
19	CL21C680JCANNN □		68pF	100	±5%	0.75
20	CL21C680JDCNNN □		68pF	200	±5%	0.95
21	CL21C680JHFNNN □		68pF	630	±5%	1.35
22	CL21C820JCCNNN □		82pF	100	±5%	0.95
23	CL21C101JCANNN □		100pF	100	±5%	0.75
24	CL21C101JDCNNN □		100pF	200	±5%	0.95
25	CL21C101JECNNN □		100pF	250	±5%	0.95

※ □mark means packaging code. If you want to learn the code or quantity in detail, please see p80.

Product Lineup (Medium-High Voltage Capacitors-C0G)

	Part Number	Size L × W (mm)	Capacitance	Rated Voltage (Vdc)	Capacitance Tolerance	Thickness Max. (mm)	
26	CL21C121JDCNNN □	2.00×1.25	120pF	200	±5%	0.95	
27	CL21C151JCANNN □		150pF	100	±5%	0.75	
28	CL21C151JHFNNN □		150pF	630	±5%	1.35	
29	CL21C221JCANNN □		220pF	100	±5%	0.75	
30	CL21C221JDCNNN □		220pF	200	±5%	0.95	
31	CL21C331JCANNN □		330pF	100	±5%	0.75	
32	CL21C471JCCNNN □		470pF	100	±5%	0.95	
33	CL21C561JCCNNN □		560pF	100	±5%	0.95	
34	CL21C561JHFNNN □		560pF	630	±5%	1.35	
35	CL21C681JCCNNN □		680pF	100	±5%	0.95	
36	CL21C102JCFNNN □		1nF	100	±5%	1.35	
37	CL21C102JDFNNN □		1nF	200	±5%	1.35	
38	CL21C272JDFNNN □		2.7nF	200	±5%	1.35	
39	CL21C272JEFNNN □		2.7nF	250	±5%	1.35	
40	CL21C472JCFNNN □		4.7nF	100	±5%	1.35	
1	CL31C150JGFNNN □		3.20×1.60	15pF	500	±5%	1.40
2	CL31C180JGFNNN □			18pF	500	±5%	1.40
3	CL31C220JGFNNN □			22pF	500	±5%	1.40
4	CL31C220JHNNN □			22pF	2000	±5%	1.80
5	CL31C270JGFNNN □			27pF	500	±5%	1.40
6	CL31C330JGFNNN □	33pF		500	±5%	1.40	
7	CL31C390JGFNNN □	39pF		500	±5%	1.40	
8	CL31C470JGFNNN □	47pF		500	±5%	1.40	
9	CL31C470JHFNNN □	47pF		630	±5%	1.40	
10	CL31C470JIFNNN □	47μF		1000	±5%	1.40	
11	CL31C470JHNNN □	47pF		2000	±5%	1.80	
12	CL31C560JGFNNN □	56pF		500	±5%	1.40	
13	CL31C680JCCNNN □	68pF		100	±5%	1.00	
14	CL31C680JGFNNN □	68pF		500	±5%	1.40	
15	CL31C680JHFNNN □	68pF		630	±5%	1.40	
16	CL31C680JIFNNN □	68pF		1000	±5%	1.40	
17	CL31C820JGFNCN □	82pF		500	±5%	1.40	
18	CL31C101JGFNNN □	100pF		500	±5%	1.40	
19	CL31C101JHFNNN □	100pF		630	±5%	1.40	
20	CL31C101JIFNNN □	100pF		1000	±5%	1.40	
21	CL31C101JHNNN □	100pF		2000	±5%	1.80	
22	CL31C121JGFNNN □	120pF		500	±5%	1.40	
23	CL31C151JGFNNN □	150pF		500	±5%	1.40	
24	CL31C181JGFNNN □	180pF		500	±5%	1.40	
25	CL31C221JGFNNN □	220pF		500	±5%	1.40	
26	CL31C271JGFNNN □	270pF		500	±5%	1.40	
27	CL31C271JCCNNN □	270pF		100	±5%	1.00	
28	CL31C331JGFNNN □	330pF		500	±5%	1.40	
29	CL31C331JHNNN □	330pF		1000	±5%	1.80	
30	CL31C391JCCNNN □	390pF		100	±5%	1.00	
31	CL31C471JGFNNN □	470pF		500	±5%	1.40	
32	CL31C471JHFNNN □	470pF		630	±5%	1.40	
33	CL31C471JIFNNN □	470pF		1000	±5%	1.40	
34	CL31C561JCCNNN □	560pF		100	±5%	1.00	
35	CL31C561JGFNNN □	560pF		500	±5%	1.40	
36	CL31C681JGFNNN □	680pF		500	±5%	1.80	
37	CL31C821JHNNN □	820pF		630	5%	1.80	

※ □mark means packaging code. If you want to learn the code or quantity in detail, please see p80.

Part Numbering System

General Capacitors

High Capacitance Capacitors

Super Small Size Capacitors

Medium-High Voltage Capacitors

Array Type Capacitors

Low ESL Capacitors

Reliability Test Condition

Premium Capacitors for Automotive Applications

Packaging Specification

Application Manual for Surface Mounting



Product Lineup (Medium-High Voltage Capacitors-C0G)

	Part Number	Size L × W (mm)	Capacitance	Rated Voltage (Vdc)	Capacitance Tolerance	Thickness Max. (mm)	
36	CL31C102JCCNNN □	3.20×1.60	1nF	100	±5%	1.00	
37	CL31C102JGHNNN □		1nF	500	±5%	1.80	
38	CL31C152JCCNNN □		1.5nF	100	±5%	1.00	
39	CL31C222JCCNNN □		2.2nF	100	±5%	1.00	
40	CL31C332JGHNNN □		3.3nF	500	±5%	1.80	
41	CL31C332JHHNNN □		3.3nF	630	±5%	1.80	
42	CL31C392JCHNNN □		3.9nF	100	±5%	1.80	
43	CL31C822JDHNNN □		8.2nF	200	±5%	1.80	
44	CL31C822JEHNNN □		8.2nF	250	±5%	1.80	
45	CL31C183JCHNNN □		18nF	100	±5%	1.80	
1	CL32C101JJFNNN □		3.20×2.50	100pF	2000	±5%	1.45
2	CL32C471JJJNNN □			470pF	2000	±5%	2.70
3	CL32C821JIJNNN □			820pF	1000	±5%	2.70
4	CL32C103JGJNNN □			10nF	500	±5%	2.70
5	CL32C103JHJNNN □			10nF	630	±5%	2.70
6	CL32C273JDJNNN □	27nF		200	±5%	2.70	
7	CL32C273JEJNNN □	27nF		250	±5%	2.70	
8	CL32C563JCJNNN □	56nF		100	±5%	2.70	
1	CL42C100JKFNNN □	4.50×2.00	10pF	3000	±5%	1.45	
2	CL42C151JKINNN □		150pF	3000	±5%	2.20	
3	CL42C221JJHNNN □		220pF	2000	±5%	1.80	
1	CL43C391KJNNN □	4.50×3.20	390pF	3000	±5%	2.70	
2	CL43C102JIHNNN □		1nF	1000	±5%	1.80	
3	CL43C122JIJNNN □		1.2nF	1000	±5%	2.20	
4	CL43C182JIJNNN □		1.8nF	1000	±5%	2.70	
5	CL43C182JJJNNN □		1.8nF	2000	±5%	2.70	
6	CL43C223JGJNNN □		22nF	500	±5%	2.70	
7	CL43C223JHJNNN □		22nF	630	±5%	2.70	
8	CL43C473JDJNNN □		47nF	200	±5%	2.70	
9	CL43C473JEJNNN □		47nF	250	±5%	2.70	
10	CL43C563JCJNNN □		56nF	100	±5%	2.70	
1	CL55C102JJJNNN □	5.70×5.00	1nF	2000	±5%	2.70	
2	CL55C102KJNNN □		1nF	3000	±5%	2.70	
3	CL55C362JIJNNN □		3.6nF	1000	±5%	2.70	
4	CL55C223JGJNNN □		22nF	500	±5%	2.70	
5	CL55C223JHJNNN □		22nF	630	±5%	2.70	
6	CL55C473JDJNNN □		47nF	200	±5%	2.70	
7	CL55C473JEJNNN □		47nF	250	±5%	2.70	
8	CL55C683JCJNNN □		68nF	100	±5%	2.70	

※ □mark means packaging code. If you want to learn the code or quantity in detail, please see p80.

Product Lineup (Medium-High Voltage Capacitors-X7R)

	Part Number	Size L × W (mm)	Capacitance	Rated Voltage (Vdc)	Capacitance Tolerance	Thickness Max. (mm)
1	CL10B102KC8NNN □	1.60×0.80	1nF	100	±10%	0.90
2	CL10B472KC8NNN □		4.7nF	100	±10%	0.90
3	CL10B103KC8NNN □		10nF	100	±10%	0.90
4	CL10B104KC8NNN □		100nF	100	±10%	0.90
1	CL21B221KDCNNN □	2.00×1.25	220pF	200	±10%	0.95
2	CL21B221KCANNN □		220pF	100	±10%	0.75
3	CL21B331KDCNNN □		330pF	200	±10%	0.95
4	CL21B471KCANNN □		470pF	100	±10%	0.75
5	CL21B102KDCNNN □		1nF	200	±10%	0.95
6	CL21B102KCANNN □		1nF	100	±10%	0.75
7	CL21B222KDCNNN □		2.2nF	200	±10%	0.95
8	CL21B222KCANNN □		2.2nF	100	±10%	0.75
9	CL21B332KCANNN □		3.3nF	100	±10%	0.75
10	CL21B472KDCNNN □		4.7nF	200	±10%	0.95
11	CL21B472KCANNN □		4.7nF	100	±10%	0.75
12	CL21B682KCANNN □		6.8nF	100	±10%	0.75
13	CL21B103KDCNNN □		10nF	200	±10%	0.95
14	CL21B103KCANNN □		10nF	100	±10%	0.75
15	CL21B153KEFNNN □		15nF	250	±10%	1.35
16	CL21B153KDFNNN □		15nF	200	±10%	1.35
17	CL21B153KCCNNN □		15nF	100	±10%	0.95
18	CL21B223KCFNNN □		22nF	100	±10%	1.35
19	CL21B473KCFNNN □		47nF	100	±10%	1.35
20	CL21B683KCFNNN □		68nF	100	±10%	1.35
21	CL21B154KCFNNN □		150nF	100	±10%	1.35
22	CL21B224KCFNNN □		220nF	100	±10%	1.35
1	CL31B221KGFNNN □	3.20×1.60	220pF	500	±10%	1.40
2	CL31B471KGFNNN □		470pF	500	±10%	1.40
3	CL31B471KDCNNN □		470pF	200	±10%	1.00
4	CL31B102KJHNNN □		1nF	2000	±10%	1.80
5	CL31B102KI FNNN □		1nF	1000	±10%	1.40
6	CL31B102KGFNNN □		1nF	500	±10%	1.40
7	CL31B102KHFNNN □		1nF	630	±10%	1.40
8	CL31B152KGFNNN □		1.5nF	500	±10%	1.40
9	CL31B152KJHNNN □		1.5nF	2000	±10%	1.80
10	CL31B222KI FNNN □		2.2nF	1000	±10%	1.40
11	CL31B222KDCNNN □		2.2nF	200	±10%	1.00
12	CL31B222KGFNNN □		2.2nF	500	±10%	1.40
13	CL31B222KJHNNN □		2.2nF	2000	±10%	1.80
14	CL31B332KGFNNN □		3.3nF	500	±10%	1.40
15	CL31B332KIFNNN □		3.3nF	1000	±10%	1.40
16	CL31B472KGFNNN □		4.7nF	500	±10%	1.40

※ □mark means packaging code. If you want to learn the code or quantity in detail, please see p80.

- Part Numbering System
- General Capacitors
- High Capacitance Capacitors
- Super Small Size Capacitors
- Medium-High Voltage Capacitors
- Array Type Capacitors
- Low ESL Capacitors
- Reliability Test Condition
- Premium Capacitors for Automotive Applications
- Packaging Specification
- Application Manual for Surface Mounting

Product Lineup (Medium-High Voltage Capacitors-X7R)

	Part Number	Size L × W (mm)	Capacitance	Rated Voltage (Vdc)	Capacitance Tolerance	Thickness Max. (mm)	
17	CL31B472KDCNNN □	3.20×1.60	4.7nF	200	±10%	1.00	
18	CL31B682KGFNNN □		6.8nF	500	±10%	1.40	
19	CL31B103KHFNNN □		10nF	630	±10%	1.40	
20	CL31B103KGFNNN □		10nF	500	±10%	1.40	
21	CL31B103KFC5NN □		10nF	350	±10%	1.00	
22	CL31B153KDCNNN □		15nF	200	±10%	1.00	
23	CL31B153KFC5NN □		15nF	350	±10%	1.00	
24	CL31B153KCCNNN □		15nF	100	±10%	1.00	
25	CL31B153KGFNNN □		15nF	500	±10%	1.40	
26	CL31B153KHFNNN □		15nF	630	±10%	1.40	
27	CL31B223KDCNNN □		22nF	200	±10%	1.00	
28	CL31B223KCCNNN □		22nF	100	±10%	1.00	
29	CL31B223KFC5NN □		22nF	350	±10%	1.00	
30	CL31B223KGHNNN □		22nF	500	±10%	1.80	
31	CL31B223KHHNNN □		22nF	630	±10%	1.80	
32	CL31B333KDFNNN □		33nF	200	±10%	1.40	
33	CL31B333KFESNN □		33nF	350	±10%	1.25	
34	CL31B333KCCNNN □		33nF	100	±10%	1.00	
35	CL31B333KGHNNN □		33nF	500	±10%	1.80	
36	CL31B333KHHNNN □		33nF	630	±10%	1.80	
37	CL31B473KDFNNN □		47nF	200	±10%	1.40	
38	CL31B473KFHSNN □		47nF	350	±10%	1.80	
39	CL31B473KCCNNN □		47nF	100	±10%	1.00	
40	CL31B473KEHNNN □		47nF	250	±10%	1.80	
41	CL31B683KEHNNN □		68nF	250	±10%	1.80	
42	CL31B104KDHNNN □		100nF	200	±10%	1.80	
43	CL31B104KCFNNN □		100nF	100	±10%	1.40	
44	CL31B104KEHNNN □		100nF	250	±10%	1.80	
45	CL31B154KCHNNN □		150nF	100	±10%	1.80	
46	CL31B105KCHNNN □		1μF	100	±10%	1.80	
47	CL31B155KCHNNN □		1.5μF	100	±10%	1.80	
48	CL31B225KCHNNN □		2.2μF	100	±10%	1.80	
1	CL32B102KJFNNN □		3.20×2.50	1nF	2000	±10%	1.45
2	CL32B472KHFNNN □			4.7nF	630	±10%	1.45
3	CL32B472KIFNNN □			4.7nF	1000	±10%	1.45
4	CL32B682KIFNNN □			6.8nF	1000	±10%	1.45
5	CL32B103KCFNNN □			10nF	100	±10%	1.45
6	CL32B153KGFNNN □			15nF	500	±10%	1.45
7	CL32B223KGFNNN □			22nF	500	±10%	1.45
8	CL32B333KHHNNN □			33nF	630	±10%	1.80
9	CL32B333KGHNNN □			33nF	500	±10%	1.80
10	CL32B473KHHNNN □			47nF	630	±10%	1.80
11	CL32B473KDHNNN □		3.20×2.50	47nF	200	±10%	1.80
12	CL32B473KGHNNN □			47nF	500	±10%	1.80
13	CL32B683KDINNN □			68nF	200	±10%	2.20
14	CL32B104KE JNNN □			100nF	250	±10%	2.70
15	CL32B104KDINNN □			100nF	200	±10%	2.20
16	CL32B154KCFNNN □			150nF	100	±10%	1.45
17	CL32B154KDJNNN □	150nF		200	±10%	2.70	
18	CL32B154KEJNNN □	150nF		250	±10%	2.70	
19	CL32B224KCHNNN □	220nF		100	±10%	1.80	
20	CL32B224KDJNNN □	220nF		200	±10%	2.70	
21	CL32B224KEJNNN □	220nF		250	±10%	2.70	
22	CL32B334KCHNNN □	330nF		100	±10%	1.80	
23	CL32B474KCIINN □	470nF		100	±10%	2.20	
24	CL32B105KCIINN □	1μF		100	±10%	2.70	
25	CL32B155KCHNNN □	1.5μF		100	±10%	1.80	
26	CL32B225KCIINN □	2.2μF		100	±10%	2.70	
1	CL43B102KJFNNN □	4.50×3.20		1nF	2000	±10%	1.45
2	CL43B152KJFNNN □			1.5nF	2000	±10%	1.45
3	CL43B222KJFNNN □		2.2nF	1000	±10%	1.45	
4	CL43B222KJFNNN □		2.2nF	2000	±10%	1.45	
5	CL43B332KJFNNN □		3.3nF	2000	±10%	1.45	
6	CL43B103KIFNNN □		10nF	1000	±10%	1.45	
7	CL43B333KIJNNN □		33nF	1000	±10%	2.70	
8	CL43B473KGFNNN □		47nF	500	±10%	1.45	
9	CL43B473KHFNNN □		47nF	630	±10%	1.45	
10	CL43B104KGINNN □		100nF	500	±10%	2.20	
11	CL43B104KDFNNN □		100nF	200	±10%	1.45	
12	CL43B104KHINNN □		100nF	630	±10%	2.20	
13	CL43B224KCFNNN □		220nF	100	±10%	1.45	
14	CL43B334KCFNNN □		330nF	100	±10%	1.45	
15	CL43B474KEJNNN □		470nF	250	±10%	2.70	
16	CL43B474KCHNNN □		470nF	100	±10%	1.80	
17	CL43B474KDJNNN □		470nF	200	±10%	2.70	
18	CL43B105KCIINN □		1μF	100	±10%	2.70	
1	CL55B103KJHNNN □	5.70×5.00	10nF	2000	±10%	1.80	
2	CL55B473KIINNN □		47nF	1000	±10%	2.20	
3	CL55B224KJNNN □		220nF	500	±10%	2.70	
4	CL55B224KHJNNN □		220nF	630	±10%	2.70	
5	CL55B105KCHNNN □		1μF	100	±10%	1.80	
6	CL55B105KDJNNN □		1μF	200	±10%	2.70	
7	CL55B105KEJNNN □		1μF	250	±10%	2.70	
8	CL55B475KCIINN □		4.7μF	100	±10%	2.70	

※ □mark means packaging code. If you want to learn the code or quantity in detail, please see p80.

Product Lineup (Medium-High Voltage Capacitors-X7R)

	Part Number	Size L × W (mm)	Capacitance	Rated Voltage (Vdc)	Capacitance Tolerance	Thickness Max. (mm)	
11	CL32B473KDHNNN □	3.20×2.50	47nF	200	±10%	1.80	
12	CL32B473KGHNNN □		47nF	500	±10%	1.80	
13	CL32B683KDINNN □		68nF	200	±10%	2.20	
14	CL32B104KE JNNN □		100nF	250	±10%	2.70	
15	CL32B104KDINNN □		100nF	200	±10%	2.20	
16	CL32B154KCFNNN □		150nF	100	±10%	1.45	
17	CL32B154KDJNNN □		150nF	200	±10%	2.70	
18	CL32B154KEJNNN □		150nF	250	±10%	2.70	
19	CL32B224KCHNNN □		220nF	100	±10%	1.80	
20	CL32B224KDJNNN □		220nF	200	±10%	2.70	
21	CL32B224KEJNNN □		220nF	250	±10%	2.70	
22	CL32B334KCHNNN □		330nF	100	±10%	1.80	
23	CL32B474KCIINN □		470nF	100	±10%	2.20	
24	CL32B105KCIINN □		1μF	100	±10%	2.70	
25	CL32B155KCHNNN □		1.5μF	100	±10%	1.80	
26	CL32B225KCIINN □		2.2μF	100	±10%	2.70	
1	CL43B102KJFNNN □		4.50×3.20	1nF	2000	±10%	1.45
2	CL43B152KJFNNN □			1.5nF	2000	±10%	1.45
3	CL43B222KJFNNN □	2.2nF		1000	±10%	1.45	
4	CL43B222KJFNNN □	2.2nF		2000	±10%	1.45	
5	CL43B332KJFNNN □	3.3nF		2000	±10%	1.45	
6	CL43B103KIFNNN □	10nF		1000	±10%	1.45	
7	CL43B333KIJNNN □	33nF		1000	±10%	2.70	
8	CL43B473KGFNNN □	47nF		500	±10%	1.45	
9	CL43B473KHFNNN □	47nF		630	±10%	1.45	
10	CL43B104KGINNN □	100nF		500	±10%	2.20	
11	CL43B104KDFNNN □	100nF		200	±10%	1.45	
12	CL43B104KHINNN □	100nF		630	±10%	2.20	
13	CL43B224KCFNNN □	220nF		100	±10%	1.45	
14	CL43B334KCFNNN □	330nF		100	±10%	1.45	
15	CL43B474KEJNNN □	470nF		250	±10%	2.70	
16	CL43B474KCHNNN □	470nF		100	±10%	1.80	
17	CL43B474KDJNNN □	470nF		200	±10%	2.70	
18	CL43B105KCIINN □	1μF		100	±10%	2.70	
1	CL55B103KJHNNN □	5.70×5.00	10nF	2000	±10%	1.80	
2	CL55B473KIINNN □		47nF	1000	±10%	2.20	
3	CL55B224KJNNN □		220nF	500	±10%	2.70	
4	CL55B224KHJNNN □		220nF	630	±10%	2.70	
5	CL55B105KCHNNN □		1μF	100	±10%	1.80	
6	CL55B105KDJNNN □		1μF	200	±10%	2.70	
7	CL55B105KEJNNN □		1μF	250	±10%	2.70	
8	CL55B475KCIINN □		4.7μF	100	±10%	2.70	

※ □mark means packaging code. If you want to learn the code or quantity in detail, please see p80.

- Part Numbering System
- General Capacitors
- High Capacitance Capacitors
- Super Small Size Capacitors
- Medium-High Voltage Capacitors
- Array Type Capacitors
- Low ESL Capacitors
- Reliability Test Condition
- Premium Capacitors for Automotive Applications
- Packaging Specification
- Application Manual for Surface Mounting

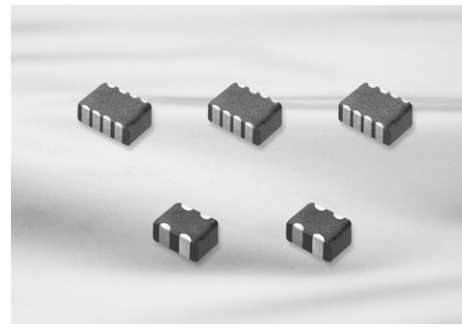

## Feature

- Reduction in required space (more than 50%)
- Reduction in cost and time for replacement of PCB
- Reduction in amount of solder joints
- Easier PCB design
- Reduced waste from tape and reel packaging process
- It protect EMI bypassing digital signal line nose

## Application

- A bypass for digital and analog signal line noise generated by telecommunication equipment and other common electronic circuits

## Structure and Dimensions

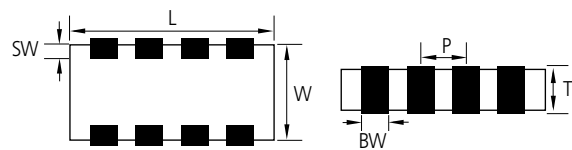

Code	Size (mm)	EIA Code	Dimension (mm)					
			L	W	T	BW	SW	P
A	0906	0302	0.90 ± 0.05	0.60 ± 0.05	0.45 ± 0.05	0.25 ± 0.05	0.15 ± 0.1	0.45 ± 0.05
A	1410	0504	1.37 ± 0.15	1.0 ± 0.15	0.35 ± 0.05 0.50 ± 0.05 0.60 ± 0.06 0.80 ± 0.08	0.36 ± 0.1	0.2 ± 0.1	0.64 ± 0.1
A	2012	0805	2.0 ± 0.15	1.25 ± 0.15	0.85 ± 0.1	0.5 ± 0.2	0.25 ± 0.15	1.0 ± 0.1
B	2012	0805	2.0 ± 0.15	1.25 ± 0.15	0.85 ± 0.1	0.25 ± 0.1	0.25 ± 0.15	0.5 ± 0.1
B	3216	1206	3.2 ± 0.15	1.6 ± 0.15	0.85 ± 0.15	0.4 ± 0.2	0.3 ± 0.15	0.8 ± 0.2

## Structure and Control Code

### ■ A : ARRAY(2-element)

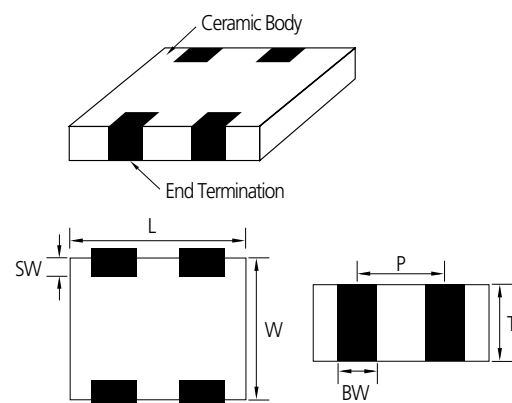

### ■ B : ARRAY(4-element)

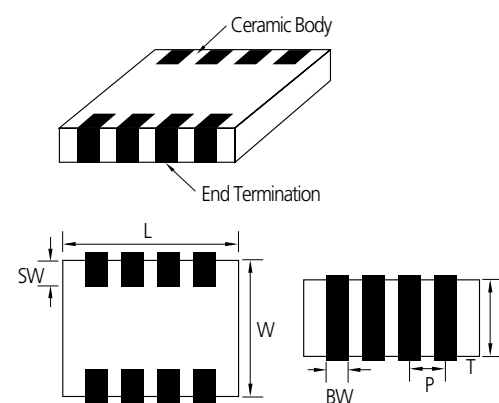

## Array Type Capacitors Table (C0G, X5R, X7R, Y5V)

TC	Size (mm)	Type	Vr (V)	Tmax (mm)	Capacitance (pF)															
					10	22	27	47	100	470										
C0G	0504(1410)	2-element	25	0.88																
	1206(3216)	4-element	50	1.00																
TC	Size (mm)	Type	Vr (V)	Tmax (mm)	Capacitance (nF)															
					1	2.2	4.7	10	22	47	100	220	470	1000	2200					
X5R	0302(0906)	2-element	4	0.50																
			6.3																	
			10																	
		0504(1410)	2-element		6.3	0.88														
						0.66														
						0.55														
					0.40															
					10	0.88														
						0.66														
	0.55																			
	16		0.88																	
			0.66																	
		0.55																		
	25	0.88																		
		0.66																		
		0.55																		
	0805(2012)	2-element	6.3																	
			10																	
16																				
0805(2012)	4-element	10	0.95																	
		16																		
	X7R	4-element		16																
				25																
		1206(3216)		4-element	50															
					25															
Y5V	1206(3216)	4-element	25	1.00																
			50																	

Part Numbering System

General Capacitors

High Capacitance Capacitors

Super Small Size Capacitors

Medium-High Voltage Capacitors

Array Type Capacitors

Low ESL Capacitors

Reliability Test Condition

Premium Capacitors for Automotive Applications

Packaging Specification

Application Manual for Surface Mounting

Product Lineup (Array Type Capacitors)

	Part Number	Element Type	Size L×W (mm)	Capacitance	Rated Voltage (Vdc)	Capacitance Tolerance	Thickness Max. (mm)
1	CL14C270KA6NAN □	2-Array	1.40×1.00	27 pF	25	±10%	0.66
1	CL31C100JBCNBN □	4-Array	3.20×1.60	10 pF	50	±5%	1.00
2	CL31C150JBCNBN □			15 pF	50	±5%	1.00
3	CL31C220JBCNBN □			22 pF	50	±5%	1.00
4	CL31C270JBCNBN □			27 pF	50	±5%	1.00
5	CL31C330KBCNBN □			33 pF	50	±10%	1.00
6	CL31C390KBCNBN □			39 pF	50	±10%	1.00
7	CL31C680JBCNBN □			68 pF	50	±5%	1.00
8	CL31C820JBCNBN □			82 pF	50	±5%	1.00
9	CL31C101JBCNBN □			100 pF	50	±5%	1.00
10	CL31C151KBCNBN □			150 pF	50	±10%	1.00
11	CL31C181JBCNBN □			180 pF	50	±5%	1.00
12	CL31C331JBCNBN □			330 pF	50	±5%	1.00
13	CL31C471JBCNBN □			470 pF	50	±5%	1.00
1	CL21B471KBCNBN □	4-Array	2.00×1.25	470 pF	50	±10%	0.95
2	CL21B104KOCNBN □			100 nF	16	±10%	0.95
3	CL21B104MPCNBN □			100 nF	10	±20%	0.95
1	CL31B102MBCNBN □	4-Array	3.20×1.60	1 nF	50	±20%	1.00
2	CL31B103MBCNBN □			10 nF	50	±20%	1.00
3	CL31B153KBCNBN □			15 nF	50	±10%	1.00
4	CL31B473KACNBN □			47 nF	25	±10%	1.00
5	CL31B104KACNBN □			100 nF	25	±10%	1.00
6	CL31B104KOCNBN □			100 nF	16	±10%	1.00
1	CL09A104KP4SAN □	2-Array	0.90×0.60	100 nF	10	±10%	0.50
2	CL09A104KQ4SAN □			100 nF	6.3	±10%	0.50
3	CL09A105MQ4NAN □			1 μF	6.3	±20%	0.50
4	CL09A105MR4NAN □			1 μF	4	±20%	0.50
1	CL14A104KA6NAN □	2-Array	1.40×1.00	100 nF	25	±10%	0.66
2	CL14A104KO6NAN □			100 nF	16	±10%	0.66
3	CL14A104KP6NAN □			100 nF	10	±10%	0.66
4	CL14A105MA5NAN □			1 μF	25	±20%	0.55
5	CL14A105KP8NAN □			1 μF	10	±10%	0.88
6	CL14A105MO3NAN □			1 μF	16	±20%	0.40
7	CL14A105MO8NAN □			1 μF	16	±20%	0.88
8	CL14A105MO5NAN □			1 μF	16	±20%	0.55
9	CL14A105MP3NAN □			1 μF	10	±20%	0.40
10	CL14A105MP5NAN □			1 μF	10	±20%	0.55
11	CL14A225KP8NAN □			2.2 μF	10	±10%	0.88
12	CL14A225KQ8NAN □			2.2 μF	6.3	±10%	0.88
1	CL21A105KOCNAN □	2-Array	2.00×1.25	1 μF	16	±10%	0.95
2	CL21A105MPCNAN □			1 μF	10	±20%	0.95
1	CL31F473ZBCNBN □	4-Array	3.20×1.60	47 nF	50	+80/-20%	1.00
2	CL31F104ZACNBN □			100 nF	25	+80/-20%	1.00

※ □ mark means packaging code. If you want to learn the code or quantity in detail, please see p80.

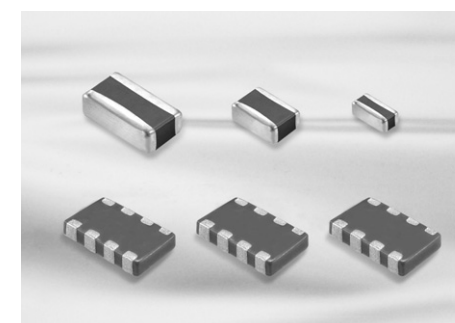

Feature

- Low ESL, good for noise reduction for high frequency
- Highly reliable tolerance and high speed automatic chip placement on PCBs
- Highly reliable performance
- Highly resistant termination metal
- Tape & reel for surface mount assembly

Application

- High Speed Microprocessor
- High Frequency Digital Equipment

LICC(Low Inductance Ceramic Capacitors)

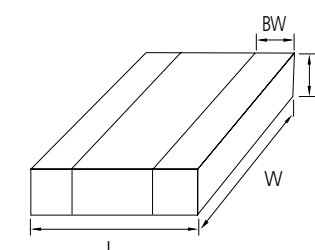

Code	Size (mm)	EIA Code	Dimension(mm)			
			L	W	T	BW
L5	0510	0204	0.52±0.05	1.0±0.05	0.3±0.05	0.18±0.08
01	0816	0306	0.8±0.15	1.6±0.2	0.5+0.05/-0.1	0.25±0.15

SLIC(Super Low Inductance Capacitors)

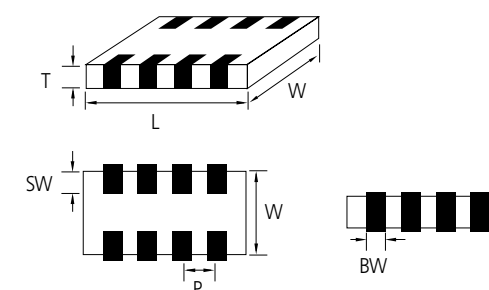

Code	Size (mm)	EIA Code	Dimension(mm)					
			L	W	T	BW	SW	P
10	1608	0603	1.6±0.1	0.8±0.1	0.5/+0.05-0.1	0.25±0.1	0.15±0.1	0.4±0.1
21	2012	0805	2.0±0.1	1.25±0.1	0.5/+0.05-0.1	0.25+0.15-0.1	0.2+0.15-0.1	0.5±0.1

Part Numbering System

General Capacitors

High Capacitance Capacitors

Super Small Size Capacitors

Medium-High Voltage Capacitors

Array Type Capacitors

Low ESL Capacitors

Reliability Test Condition

Premium Capacitors for Automotive Applications

Packaging Specification

Application Manual for Surface Mounting

Low ESL Capacitors Table (LICC)

TC	Size(mm)	Tmax(mm)	Vr(V)	Capacitance (uF)												
				0.01	0.022	0.047	0.1	0.22	0.47	1	2.2	4.7	10			
X6S /X7S /X7T	0204(0510)	0.35	2.5									X7T				
			4				X7S		X6S							
	6.3				X7S											
	0306(0816)	0.55	4									X7S				

TC	Size(mm)	Tmax(mm)	Vr(V)	Capacitance (uF)														
				0.01	0.022	0.047	0.1	0.22	0.47	1	2.2	4.7	10					
X7R /X5R	0306(0816)	0.55	6.3			X7R					X5R							
			10			X7R												
			16			X7R												
			25			X7R												
			50			X7R												

Low ESL Capacitors Table (SLIC)

TC	Size(mm)	Tmax(mm)	Vr(V)	Capacitance (uF)									
				0.1	0.47	0.68	1	2.2	4.7	10	22		
X7R /X7S /X7T	0603(1608)	0.55	2.5										
			4			X7S							
	0805(2012)	0.55	4			X7R			X7S				
			6.3			X7R							
			16			X7R							

Product Lineup (Low ESL Capacitors-X7R, X6S, X7S, X7T)

	Part Number	Size L×W (mm)	Capacitance	Rated Voltage (Vdc)	Capacitance Tolerance	Thickness Max. (mm)
1	CL21B104MO5N1N □	2.00×1.25	100nF	16	±20%	0.55
2	CL21B684MO5N1N □		680nF	16	±20%	0.55
3	CL21B684MQ5N1N □		680nF	6.3	±20%	0.55
1	CLL5X224MR3NLN □	0.50×1.00	220nF	4	±20%	0.35
2	CLL5X474MR3NLN □		470nF	4	±20%	0.35
3	CLL5X105MR3NLN □		1μF	4	±20%	0.35
1	CLL5Y104MQ3NLN □	0.50×1.00	100nF	6.3	±20%	0.35
1	CL01Y105MR5NLN □	0.80×1.60	1μF	4	±20%	0.55
2	CL01Y225MR5NLN □		2.2μF	4	±20%	0.55
1	CL10Y474MR5N1N □	1.60×0.80	470nF	4	±20%	0.55
2	CL10Y105MR5N1N □		1μF	4	±20%	0.55
3	CL10Y225MR5N1N □		2.2μF	4	±20%	0.55
1	CL21Y105MR5N1N □	2.00×1.25	1μF	4	±20%	0.55
2	CL21Y225MR5N1N □		2.2μF	4	±20%	0.55
1	CLL5Z105MS3NLN □	0.50×1.00	1μF	2.5	±20%	0.35

※ □ mark means packaging code. If you want to learn the code or quantity in detail, please see p80.

Part Numbering System

General Capacitors

High Capacitance Capacitors

Super Small Size Capacitors

Medium-High Voltage Capacitors

Array Type Capacitors

Low ESL Capacitors

Reliability Test Condition

Premium Capacitors for Automotive Applications

Packaging Specification

Application Manual for Surface Mounting

No	Item	Performance	Test Condition																											
1	Appearance	No abnormal exterior appearance	Visual Inspection through Microscope(× 10)																											
2	Insulation Resistance	10,000MΩ min. or 500MΩ · μF min. (or *100MΩ · μF) product whichever is smaller (Rated voltage ≤ 16V: 10,000MΩ min. or 100MΩ · μF min. product whichever is smaller)	Apply the rated voltage for 60~120 sec. Rated voltage > 500V: Insulation Resistance shall be measured with 500 ± 50Vdc																											
3	Withstanding Voltage	No dielectric breakdown or mechanical breakdown	Apply the specified voltage* for 1~5 sec. Charge/Discharge current limit: 50mA max. *CLASS I (Rated Voltage < 100V): 300% of the rated Voltage CLASS II (Rated Voltage < 100V): 250% of the rated Voltage  In the case of Vr ≥ 100V products, following condition should be applied. 100V ≤ Rated Voltage < 500V: 200% of the rated Voltage 500V ≤ Rated Voltage < 1000V: 150% of the rated Voltage Rated Voltage ≥ 1000V: 120% of the rated Voltage																											
4	Capacitance	CLASS I Within the specified tolerance	<table border="1"> <thead> <tr> <th>Capacitance</th> <th>Frequency</th> <th>Voltage</th> </tr> </thead> <tbody> <tr> <td>≤ 1,000pF</td> <td>1MHz ± 10%</td> <td rowspan="2">0.5 ~ 5 Vrms</td> </tr> <tr> <td>&gt; 1,000pF</td> <td>1KHz ± 10%</td> </tr> </tbody> </table>	Capacitance	Frequency	Voltage	≤ 1,000pF	1MHz ± 10%	0.5 ~ 5 Vrms	> 1,000pF	1KHz ± 10%																			
		Capacitance	Frequency	Voltage																										
≤ 1,000pF	1MHz ± 10%	0.5 ~ 5 Vrms																												
> 1,000pF	1KHz ± 10%																													
CLASS II Within the specified tolerance	<table border="1"> <thead> <tr> <th>Capacitance</th> <th>Frequency</th> <th>Voltage</th> </tr> </thead> <tbody> <tr> <td>≤ 10μF</td> <td>1KHz ± 10%</td> <td>1.0 ± 0.2 Vrms</td> </tr> <tr> <td>&gt; 10μF</td> <td>120Hz ± 20%</td> <td>0.5 ± 0.1 Vrms</td> </tr> <tr> <td>*</td> <td>1KHz ± 10%</td> <td>0.5 ± 0.1 Vrms</td> </tr> </tbody> </table>	Capacitance	Frequency	Voltage	≤ 10μF	1KHz ± 10%	1.0 ± 0.2 Vrms	> 10μF	120Hz ± 20%	0.5 ± 0.1 Vrms	*	1KHz ± 10%	0.5 ± 0.1 Vrms																	
Capacitance	Frequency	Voltage																												
≤ 10μF	1KHz ± 10%	1.0 ± 0.2 Vrms																												
> 10μF	120Hz ± 20%	0.5 ± 0.1 Vrms																												
*	1KHz ± 10%	0.5 ± 0.1 Vrms																												
5	Tanδ	CLASS I Capacitance ≥ 30pF : Q ≥ 1,000 < 30pF : Q ≥ 400 + 20 × C (C : Capacitance)	<table border="1"> <thead> <tr> <th>Capacitance</th> <th>Frequency</th> <th>Voltage</th> </tr> </thead> <tbody> <tr> <td>≤ 1,000pF</td> <td>1MHz ± 10%</td> <td rowspan="2">0.5 ~ 5 Vrms</td> </tr> <tr> <td>&gt; 1,000pF</td> <td>1KHz ± 10%</td> </tr> </tbody> </table>	Capacitance	Frequency	Voltage	≤ 1,000pF	1MHz ± 10%	0.5 ~ 5 Vrms	> 1,000pF	1KHz ± 10%																			
		Capacitance	Frequency	Voltage																										
≤ 1,000pF	1MHz ± 10%	0.5 ~ 5 Vrms																												
> 1,000pF	1KHz ± 10%																													
CLASS II	<p>1. Characteristic: A(X5R)</p> <table border="1"> <thead> <tr> <th>Rated Voltage</th> <th>Spec</th> </tr> </thead> <tbody> <tr> <td>50V / 35V</td> <td>0.025 max / 0.05 max*</td> </tr> <tr> <td>25V</td> <td>0.025 max / 0.05 max* / 0.10 max*</td> </tr> <tr> <td>16V</td> <td>0.035 max / 0.05 max* / 0.10 max*</td> </tr> <tr> <td>≤ 10V</td> <td>0.05 max / 0.10 max*</td> </tr> </tbody> </table> <p>2. Characteristic: B(X7R), X(X6S), Y(X7S)</p> <table border="1"> <thead> <tr> <th>Rated Voltage</th> <th>Spec</th> </tr> </thead> <tbody> <tr> <td>50V ≥ / 35V / 25V</td> <td>0.025 max / 0.05 max* / 0.10 max*</td> </tr> <tr> <td>16V</td> <td>0.035 max / 0.10 max*</td> </tr> <tr> <td>≤ 10V</td> <td>0.05 max / 0.10 max*</td> </tr> </tbody> </table> <p>3. Characteristic: F(Y5V)</p> <table border="1"> <thead> <tr> <th>Rated Voltage</th> <th>Spec</th> </tr> </thead> <tbody> <tr> <td>50V / 35V / 25V</td> <td>0.05 max / 0.07 max* / 0.09 max*</td> </tr> <tr> <td>16V</td> <td>0.07 max / 0.09 max* / 0.125 max*</td> </tr> <tr> <td>10V</td> <td>0.125 max / 0.16 max*</td> </tr> <tr> <td>≤ 6.3V</td> <td>0.16 max</td> </tr> </tbody> </table>	Rated Voltage	Spec	50V / 35V	0.025 max / 0.05 max*	25V	0.025 max / 0.05 max* / 0.10 max*	16V	0.035 max / 0.05 max* / 0.10 max*	≤ 10V	0.05 max / 0.10 max*	Rated Voltage	Spec	50V ≥ / 35V / 25V	0.025 max / 0.05 max* / 0.10 max*	16V	0.035 max / 0.10 max*	≤ 10V	0.05 max / 0.10 max*	Rated Voltage	Spec	50V / 35V / 25V	0.05 max / 0.07 max* / 0.09 max*	16V	0.07 max / 0.09 max* / 0.125 max*	10V	0.125 max / 0.16 max*	≤ 6.3V	0.16 max	You can check the specification at the web site or contact sales people for each product with mark*
Rated Voltage	Spec																													
50V / 35V	0.025 max / 0.05 max*																													
25V	0.025 max / 0.05 max* / 0.10 max*																													
16V	0.035 max / 0.05 max* / 0.10 max*																													
≤ 10V	0.05 max / 0.10 max*																													
Rated Voltage	Spec																													
50V ≥ / 35V / 25V	0.025 max / 0.05 max* / 0.10 max*																													
16V	0.035 max / 0.10 max*																													
≤ 10V	0.05 max / 0.10 max*																													
Rated Voltage	Spec																													
50V / 35V / 25V	0.05 max / 0.07 max* / 0.09 max*																													
16V	0.07 max / 0.09 max* / 0.125 max*																													
10V	0.125 max / 0.16 max*																													
≤ 6.3V	0.16 max																													

No	Item	Performance	Test Condition												
6	Temperature Characteristics of Capacitance	CLASS I	<table border="1"> <thead> <tr> <th>Characteristic</th> <th>Temp. Coefficient (PPM/°C)</th> </tr> </thead> <tbody> <tr> <td>C</td> <td>0 ± 30</td> </tr> </tbody> </table>	Characteristic	Temp. Coefficient (PPM/°C)	C	0 ± 30								
		Characteristic	Temp. Coefficient (PPM/°C)												
C	0 ± 30														
CLASS II	<table border="1"> <thead> <tr> <th>Characteristic</th> <th>Capacitance Change (%) with No bias</th> </tr> </thead> <tbody> <tr> <td>A(X5R) / B(X7R)</td> <td>± 15%</td> </tr> <tr> <td>X(X6S), Y(X7S)</td> <td>± 22%</td> </tr> <tr> <td>Z(X7T)</td> <td>+22% ~ -33%</td> </tr> <tr> <td>F(Y5V)</td> <td>+22% ~ -82%</td> </tr> </tbody> </table>	Characteristic	Capacitance Change (%) with No bias	A(X5R) / B(X7R)	± 15%	X(X6S), Y(X7S)	± 22%	Z(X7T)	+22% ~ -33%	F(Y5V)	+22% ~ -82%				
Characteristic	Capacitance Change (%) with No bias														
A(X5R) / B(X7R)	± 15%														
X(X6S), Y(X7S)	± 22%														
Z(X7T)	+22% ~ -33%														
F(Y5V)	+22% ~ -82%														
			<p>Capacitance shall be measured by the steps shown in the following table.</p> <table border="1"> <thead> <tr> <th>Step</th> <th>Temperature(°C)</th> </tr> </thead> <tbody> <tr> <td>1</td> <td>25 ± 2</td> </tr> <tr> <td>2</td> <td>Min. Operating Temp. ± 2</td> </tr> <tr> <td>3</td> <td>25 ± 2</td> </tr> <tr> <td>4</td> <td>Max. Operating Temp. ± 2</td> </tr> <tr> <td>5</td> <td>25 ± 2</td> </tr> </tbody> </table> <p>(1) CLASS I Temperature Coefficient shall be calculated from the formula as below Temp. Coefficient = <math>\frac{C2 - C1}{C1 \times \Delta T} \times 10^6</math> [ppm/°C] C1: Capacitance at step 3 C2: Capacitance at 125°C ΔT: 100°C (= 125°C - 25°C)</p> <p>(2) CLASS II Capacitance Change shall be calculated from the formula as below <math>\Delta C = \frac{C2 - C1}{C1} \times 100(\%)</math> C1: Capacitance at step 3 C2: Capacitance at step 2 or 4</p>	Step	Temperature(°C)	1	25 ± 2	2	Min. Operating Temp. ± 2	3	25 ± 2	4	Max. Operating Temp. ± 2	5	25 ± 2
Step	Temperature(°C)														
1	25 ± 2														
2	Min. Operating Temp. ± 2														
3	25 ± 2														
4	Max. Operating Temp. ± 2														
5	25 ± 2														
7	Adhesive Strength of Termination	No indication of peeling shall occur on the terminal electrode	<p>Apply 500g.f* pressure for 10 ± 1 sec. *200g.f for 0201 *100g.f for 01005</p>												
8	Bending Strength	Appearance	No indication of peeling shall occur												
		Capacitance	<table border="1"> <thead> <tr> <th>Characteristic</th> <th>Capacitance Change</th> </tr> </thead> <tbody> <tr> <td>CLASS I</td> <td>± 5% or ± 0.5 pF whichever is larger</td> </tr> <tr> <td>CLASS II</td> <td>± 12.5%</td> </tr> <tr> <td>F(Y5V)</td> <td>± 30%</td> </tr> </tbody> </table>	Characteristic	Capacitance Change	CLASS I	± 5% or ± 0.5 pF whichever is larger	CLASS II	± 12.5%	F(Y5V)	± 30%				
Characteristic	Capacitance Change														
CLASS I	± 5% or ± 0.5 pF whichever is larger														
CLASS II	± 12.5%														
F(Y5V)	± 30%														
			<ul style="list-style-type: none"> <li>Bending Limit: 1mm</li> <li>Test Speed: 1.0mm/sec.</li> <li>Keep the test board at the limit point in 5 sec.</li> <li>Then Measure Capacitance</li> </ul>												
9	Solderability	More than 75% of the terminal surface is to be soldered newly, so metal part does not come out or dissolve	<table border="1"> <tbody> <tr> <td>Solder</td> <td>Sn-3Ag-0.5Cu</td> </tr> <tr> <td>Solder Temp.</td> <td>245 ± 5°C</td> </tr> <tr> <td>Flux</td> <td>RMA Type</td> </tr> <tr> <td>Dip time</td> <td>3 ± 0.3 sec.</td> </tr> <tr> <td>Pre-heating</td> <td>at 80~120°C for 10~30 sec.</td> </tr> </tbody> </table>	Solder	Sn-3Ag-0.5Cu	Solder Temp.	245 ± 5°C	Flux	RMA Type	Dip time	3 ± 0.3 sec.	Pre-heating	at 80~120°C for 10~30 sec.		
Solder	Sn-3Ag-0.5Cu														
Solder Temp.	245 ± 5°C														
Flux	RMA Type														
Dip time	3 ± 0.3 sec.														
Pre-heating	at 80~120°C for 10~30 sec.														
10	Resistance to Soldering Heat	Appearance	No mechanical damage shall occur												
		Capacitance	<table border="1"> <thead> <tr> <th>Characteristic</th> <th>Capacitance Change</th> </tr> </thead> <tbody> <tr> <td>CLASS I</td> <td>± 2.5% or ± 0.25 pF whichever is larger</td> </tr> <tr> <td>CLASS II</td> <td>± 7.5%</td> </tr> <tr> <td>F(Y5V)</td> <td>± 20%</td> </tr> </tbody> </table>	Characteristic	Capacitance Change	CLASS I	± 2.5% or ± 0.25 pF whichever is larger	CLASS II	± 7.5%	F(Y5V)	± 20%				
	Characteristic	Capacitance Change													
	CLASS I	± 2.5% or ± 0.25 pF whichever is larger													
	CLASS II	± 7.5%													
	F(Y5V)	± 20%													
Q (CLASS I)	Within the specified initial value														
Tanδ (CLASS II)	Within the specified initial value														
Insulation resistance	Within the specified initial value														
Withstanding voltage	Within the specified initial value														
			<p>Solder temperature: 270 ± 5°C DIP TIME: 10 ± 1 sec. Each termination shall be fully immersed and preheated as below:</p> <table border="1"> <thead> <tr> <th>Step</th> <th>Temperature(°C)</th> <th>Time (sec.)</th> </tr> </thead> <tbody> <tr> <td>1</td> <td>80~100</td> <td>60</td> </tr> <tr> <td>2</td> <td>150~180</td> <td>60</td> </tr> </tbody> </table> <p>Leave the capacitor in ambient condition for specified time* before measurement *24 ± 2 hours(CLASS I) 24 ± 2 hours(CLASS II)</p>	Step	Temperature(°C)	Time (sec.)	1	80~100	60	2	150~180	60			
Step	Temperature(°C)	Time (sec.)													
1	80~100	60													
2	150~180	60													

Part Numbering System

General Capacitors

High Capacitance Capacitors

Super Small Size Capacitors

Medium-High Voltage Capacitors

Array Type Capacitors

Low ESL Capacitors

Reliability Test Condition

Premium Capacitors for Automotive Applications

Packaging Specification

Application Manual for Surface Mounting

No	Item	Performance	Test Condition			
11	Vibration Test	Appearance	No mechanical damage shall occur			
		Capacitance	Characteristic	Capacitance Change		
			CLASS I	±2.5% or ± 0.25 pF whichever is larger		
			CLASS II	A(X5R), B(X7R)	±5%	
				X(X6S), Y(X7S) Z(X7T)	±10%	
		F(Y5V)		±20%		
		Q (CLASS I)	Within the specified initial value	Repeat this for 2hours each in 3 mutually perpendicular directions.		
Tanδ (CLASSII)	Within the specified initial value					
Insulation resistance	Within the specified initial value					
12	Moisture Resistance	Appearance	No mechanical damage shall occur			
		Capacitance	Characteristic	Capacitance Change		
			CLASS I	±7.5% or ± 0.75pF whichever is larger		
			CLASS II	A(X5R), B(X7R), X(X6S), Y(X7S) Z(X7T)	±12.5%	
				F(Y5V)	±30%	
		Q (CLASS I)		Capacitance ≥ 30pF : Q ≥ 200 < 30pF : Q ≥ 100+10/3 × C (C: Capacitance)		
		Tanδ (CLASSII)	1.Capacitance: A(X5R) 0.05 max / 0.075 max* (35V / 50V) 0.05 max / 0.075 max* / 0.125 max*(16V / 25V) 0.075 max / 0.125 max* (≤ 10V) 2.Capacitance: B(X7R), X(X6S) 0.05 max / 0.125 max* (16V / 25V / 35V / 50V ≥) 0.075 max / 0.125 max* (≤ 10V) 3.Capacitance: F(Y5V) 0.09 max (50V) 0.09 max / 0.125 max* (25V / 35V) 0.09 max / 0.125 max* / 0.16 max* (16V) 0.16 max / 0.195 max* (10V) 0.195 max (4V / 6.3V)	Applied Voltage: rated voltage Temperature: 40±2°C Humidity: 90~95% RH Duration Time: 500+12/0 Hr. Charge/Discharge Current: 50mA max.		
Insulation resistance	500MΩ min. or 25MΩ · μF min. product whichever is smaller / 12.5MΩ · μF or over*	Perform the initial measurement according to Note1. Perform the final measurement according to Note2.				
13	High Temperature Resistance	Appearance	No mechanical damage shall occur			
		Capacitance	Characteristic	Capacitance Change		
			CLASS I	±3% or ± 0.3 pF whichever is larger		
			CLASS II	A(X5R), B(X7R), X(X6S), Y(X7S) Z(X7T)	±12.5%	
				F(Y5V)	±30%	
		Q (CLASS I)		Capacitance ≥ 30pF : Q ≥ 350 10 ≤ Capacitance < 30pF : Q ≥ 275+2.5 × C Capacitance < 10pF : Q ≥ 200+10 × C (C: Capacitance)		
		Tanδ (CLASSII)	1.Capacitance: A(X5R) 0.05 max / 0.075 max* (35V / 50V) 0.05 max / 0.075 max* / 0.125 max*(16V / 25V) 0.075 max / 0.125 max* (≤ 10V) 2.Capacitance: B(X7R), X(X6S) 0.05 max / 0.125 max* (16V / 25V / 35V / 50V ≥) 0.075 max / 0.125 max* (≤ 10V) 3.Capacitance: F(Y5V) 0.09 max (50V) 0.09 max / 0.125 max* (25V / 35V) 0.09 max / 0.125 max* / 0.16 max* (16V) 0.16 max / 0.195 max* (10V) 0.195 max (4V / 6.3V)	Temperature : max. operating temperature Duration Time: 1000+48/0 Hr. Charge/Discharge Current: 50mA max. Vr ≤ 200V : 200% of the rated Voltage 250V ≤ Vr ≤ 500V: 150% of the rated Voltage Vr = 630V : 120% of the rated Voltage 1000V ≤ Vr ≤ 3000V: 100% of the rated Voltage * : 150% or 100% of the rated Voltage		
Insulation resistance	1,000MΩ min. or 50MΩ · μF min. product whichever is smaller / 25MΩ · μF or over*	Perform the initial measurement according to Note1 for class II Perform the final measurement according to Note2.				
14	Temperature Cycle	Appearance	No mechanical damage shall occur			
		Capacitance	Characteristic	Capacitance Change		
			CLASS I	±2.5% or ± 0.25pF whichever is larger		
			CLASS II	A(X5R), B(X7R)	±7.5%	
				X(X6S), Y(X7S) Z(X7T)	±15%	
		F(Y5V)		±20%		
		Q (CLASS I)	Within the specified initial value	Capacitor shall be subjected to 5 cycles. Condition for 1 cycle:		
Tanδ (CLASSII)	Within the specified initial value					
Insulation resistance	Within the specified initial value					
		Leave the capacitor in ambient condition for specified time* before measurement *24 ± 2 hours(CLASS I) 24 ± 2 hours(CLASSII)				
15	Recommended Soldering Method By Size & Capacitance	Recommended Soldering Method				
		Size inch(mm)	Temperature Characteristic	Capacitance	Condition	
					Flow	Reflow
		01005(0402)	-	-	-	○
		0201 (0603)				
		0402 (1005)				
		0603(1608)	Class I	-	○	○
			Class II	C < 1μF C ≥ 1μF	○ -	○ ○
		0805 (2012)	Class I	-	○	○
			Class II	C < 4.7μF C ≥ 4.7μF	○ -	○ ○
				Array	-	-
		1206 (3216)	Class I	-	○	○
			Class II	C < 10μF C ≥ 10μF	○ -	○ ○
				Array	-	-
		1210 (3225)	-	-	-	○
1808 (4520)						
1812 (4532)						
2220 (5750)						

No	Item	Performance	Test Condition			
11	Vibration Test	Appearance	No mechanical damage shall occur			
		Capacitance	Characteristic	Capacitance Change		
			CLASS I	±2.5% or ± 0.25 pF whichever is larger		
			CLASS II	A(X5R), B(X7R)	±5%	
				X(X6S), Y(X7S) Z(X7T)	±10%	
		F(Y5V)		±20%		
		Q (CLASS I)	Within the specified initial value	Repeat this for 2hours each in 3 mutually perpendicular directions.		
Tanδ (CLASSII)	Within the specified initial value					
Insulation resistance	Within the specified initial value					
12	Moisture Resistance	Appearance	No mechanical damage shall occur			
		Capacitance	Characteristic	Capacitance Change		
			CLASS I	±7.5% or ± 0.75pF whichever is larger		
			CLASS II	A(X5R), B(X7R), X(X6S), Y(X7S) Z(X7T)	±12.5%	
				F(Y5V)	±30%	
		Q (CLASS I)		Capacitance ≥ 30pF : Q ≥ 200 < 30pF : Q ≥ 100+10/3 × C (C: Capacitance)		
		Tanδ (CLASSII)	1.Capacitance: A(X5R) 0.05 max / 0.075 max* (35V / 50V) 0.05 max / 0.075 max* / 0.125 max*(16V / 25V) 0.075 max / 0.125 max* (≤ 10V) 2.Capacitance: B(X7R), X(X6S) 0.05 max / 0.125 max* (16V / 25V / 35V / 50V ≥) 0.075 max / 0.125 max* (≤ 10V) 3.Capacitance: F(Y5V) 0.09 max (50V) 0.09 max / 0.125 max* (25V / 35V) 0.09 max / 0.125 max* / 0.16 max* (16V) 0.16 max / 0.195 max* (10V) 0.195 max (4V / 6.3V)	Applied Voltage: rated voltage Temperature: 40±2°C Humidity: 90~95% RH Duration Time: 500+12/0 Hr. Charge/Discharge Current: 50mA max.		
Insulation resistance	500MΩ min. or 25MΩ · μF min. product whichever is smaller / 12.5MΩ · μF or over*	Perform the initial measurement according to Note1. Perform the final measurement according to Note2.				
13	High Temperature Resistance	Appearance	No mechanical damage shall occur			
		Capacitance	Characteristic	Capacitance Change		
			CLASS I	±3% or ± 0.3 pF whichever is larger		
			CLASS II	A(X5R), B(X7R), X(X6S), Y(X7S) Z(X7T)	±12.5%	
				F(Y5V)	±30%	
		Q (CLASS I)		Capacitance ≥ 30pF : Q ≥ 350 10 ≤ Capacitance < 30pF : Q ≥ 275+2.5 × C Capacitance < 10pF : Q ≥ 200+10 × C (C: Capacitance)		
		Tanδ (CLASSII)	1.Capacitance: A(X5R) 0.05 max / 0.075 max* (35V / 50V) 0.05 max / 0.075 max* / 0.125 max*(16V / 25V) 0.075 max / 0.125 max* (≤ 10V) 2.Capacitance: B(X7R), X(X6S) 0.05 max / 0.125 max* (16V / 25V / 35V / 50V ≥) 0.075 max / 0.125 max* (≤ 10V) 3.Capacitance: F(Y5V) 0.09 max (50V) 0.09 max / 0.125 max* (25V / 35V) 0.09 max / 0.125 max* / 0.16 max* (16V) 0.16 max / 0.195 max* (10V) 0.195 max (4V / 6.3V)	Temperature : max. operating temperature Duration Time: 1000+48/0 Hr. Charge/Discharge Current: 50mA max. Vr ≤ 200V : 200% of the rated Voltage 250V ≤ Vr ≤ 500V: 150% of the rated Voltage Vr = 630V : 120% of the rated Voltage 1000V ≤ Vr ≤ 3000V: 100% of the rated Voltage * : 150% or 100% of the rated Voltage		
Insulation resistance	1,000MΩ min. or 50MΩ · μF min. product whichever is smaller / 25MΩ · μF or over*	Perform the initial measurement according to Note1 for class II Perform the final measurement according to Note2.				
15	Recommended Soldering Method By Size & Capacitance	Recommended Soldering Method				
		Size inch(mm)	Temperature Characteristic	Capacitance	Condition	
					Flow	Reflow
		01005(0402)	-	-	-	○
		0201 (0603)				
		0402 (1005)				
		0603(1608)	Class I	-	○	○
			Class II	C < 1μF C ≥ 1μF	○ -	○ ○
		0805 (2012)	Class I	-	○	○
			Class II	C < 4.7μF C ≥ 4.7μF	○ -	○ ○
				Array	-	-
		1206 (3216)	Class I	-	○	○
			Class II	C < 10μF C ≥ 10μF	○ -	○ ○
				Array	-	-
		1210 (3225)	-	-	-	○
1808 (4520)						
1812 (4532)						
2220 (5750)						

Note1. Initial Measurement For Class II

Perform the heat treatment at 150°C+0/-10°C for 1 hour. Then Leave the capacitor in ambient condition for 24 ± 2 hours before measurement. Then perform the measurement.

Note2. Latter Measurement

1. CLASS I  
Leave the capacitor in ambient condition for 24 ± 2 hours before measurement. Then perform the measurement.

2. CLASSII  
Perform the heat treatment at 150°C+0/-10°C for 1 hour. Then Leave the capacitor in ambient condition for 24 ± 2 hours before measurement. Then perform the measurement.

Note3. All Size in Reliability Test Condition Section is "inch"

Note4. Camera Strobe Circuit Capacitors Should be Following a Special Reliability Test Condition.  
Please check with our sales representatives or product engineers.

- Part Numbering System
- General Capacitors
- High Capacitance Capacitors
- Super Small Size Capacitors
- Medium-High Voltage Capacitors
- Array Type Capacitors
- Low ESL Capacitors
- Reliability Test Condition
- Premium Capacitors for Automotive Applications
- Packaging Specification
- Application Manual for Surface Mounting

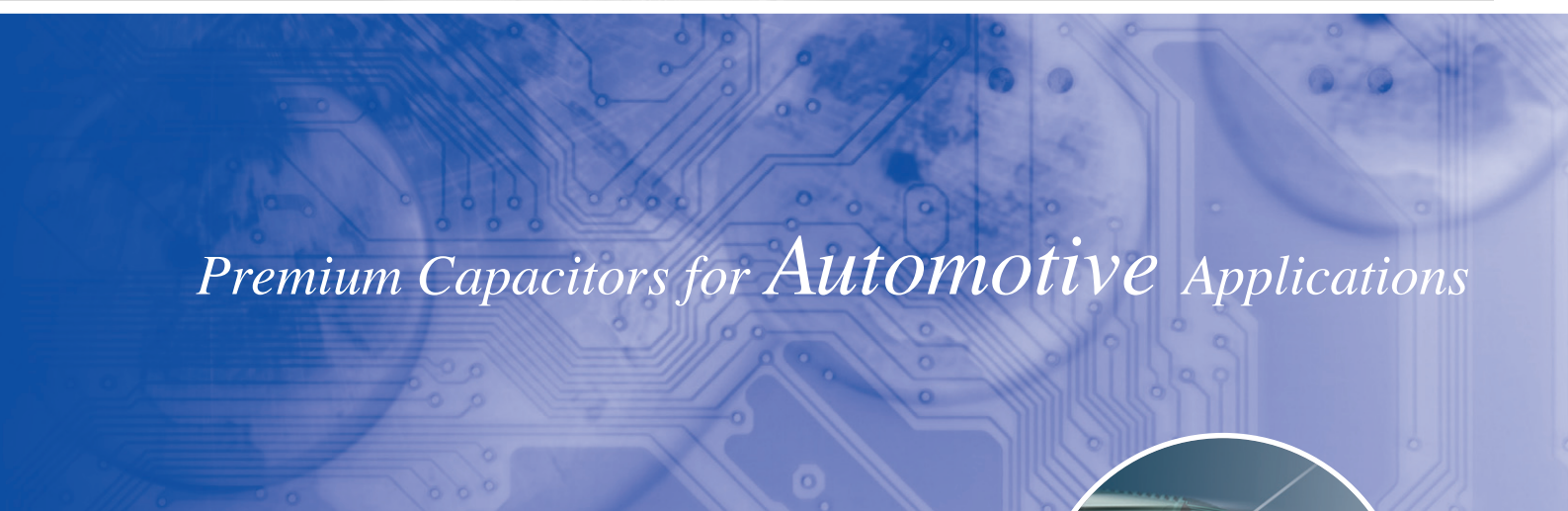
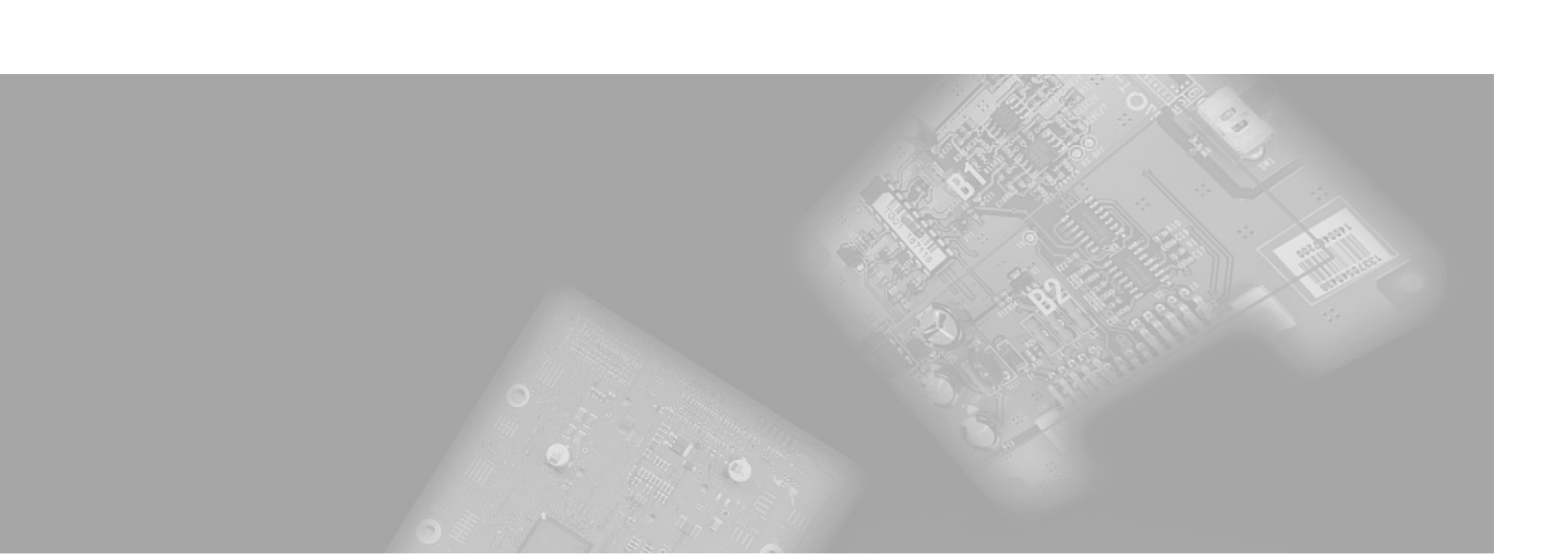
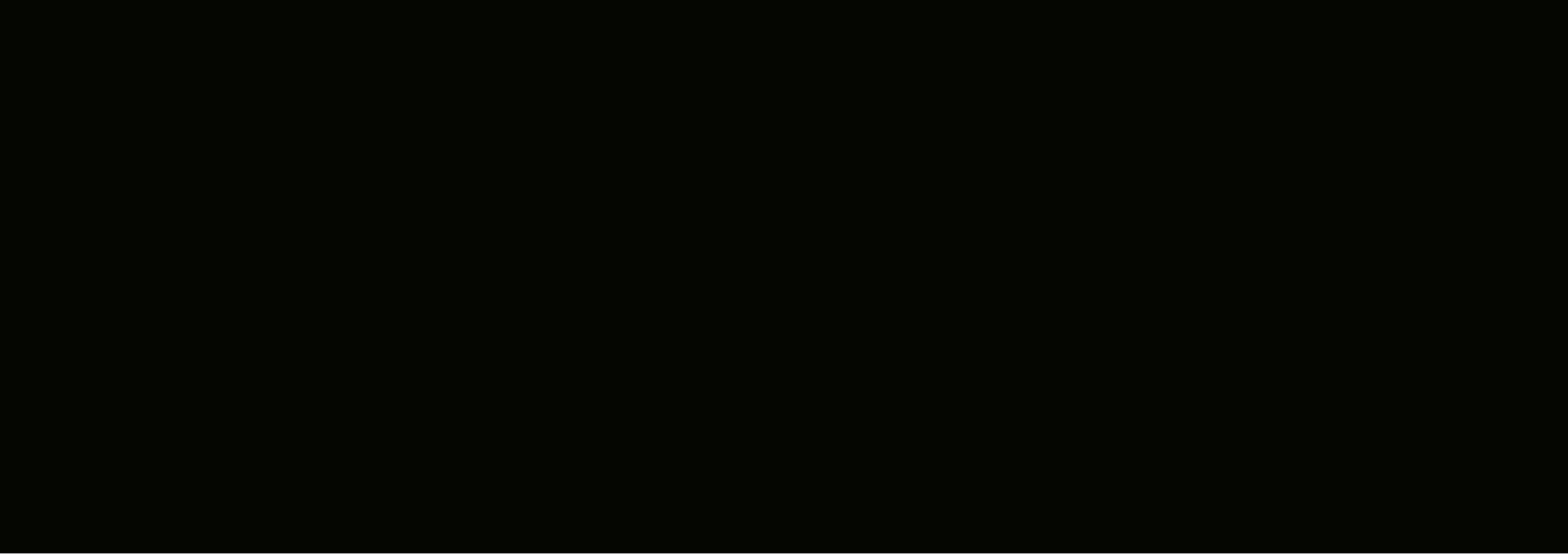

S A M S U N G E L E C T R O - M E C H A N I C S

*Premium Capacitors for Automotive Applications*

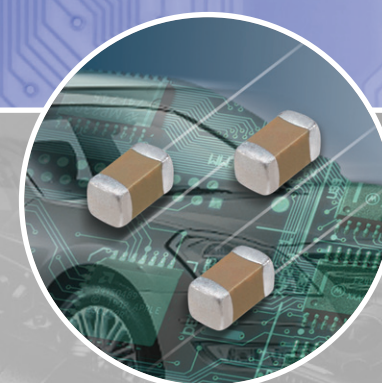



## Part Numbering System (Automotive Capacitors)

	<b>CL</b>	<b>10</b>	<b>B</b>	<b>104</b>	<b>K</b>	<b>B</b>	<b>8</b>	<b>W</b>	<b>P</b>	<b>N</b>	<b>C</b>
	<b>1</b>	<b>2</b>	<b>3</b>	<b>4</b>	<b>5</b>	<b>6</b>	<b>7</b>	<b>8</b>	<b>9</b>	<b>10</b>	<b>11</b>

- 1. SERIES CODE** \_\_\_\_\_  
CL=Multi layer Ceramic Capacitors
- 2. SIZE CODE** \_\_\_\_\_ inch (mm) \_\_\_\_\_  
05=1005(0402) 10=1608(0603) 21=2012(0805)  
31=3216(1206) 32=3225(1210)
- 3. DIELECTRIC CODE** \_\_\_\_\_  
C=COG (Class I) B=X7R (Class II)
- 4. CAPACITANCE CODE** \_\_\_\_\_  
Capacitance expressed in pF. 2 significant digits plus number of zeros.  
example) 106=10 × 10<sup>6</sup>=10000000pF  
For Values < 10pF, Letter R denotes decimal point  
example) 1R5=1.5pF
- 5. TOLERANCE CODE** \_\_\_\_\_  
C=±0.25pF D=±0.5pF F=±1pF, ±1%\* G=±2%  
J=±5% K=±10% M=±20%  
\*For Values ≤10pF, F=±1pF, Values>10pF, F=±1%  
※This code has only typical specifications. Please refer to individual specifications.
- 6. RATED VOLTAGE CODE** \_\_\_\_\_  
P=10V O=16V  
A=25V B=50V C=100V
- 7. THICKNESS CODE** \_\_\_\_\_  
5 = 0.50mm 6 = 0.60mm 8 = 0.80mm C = 0.85mm  
P = 1.15mm F,Q = 1.25mm H = 1.60mm J = 2.50mm  
※This code has only typical specifications. Please refer to individual specifications.
- 8. DESIGN CODE** \_\_\_\_\_  
1=Ni/Cu/Ni Barrier/Sn 100%/Standard  
V=Ni/Cu+Soft termination/Ni Barrier/Sn 100%/Standard  
W=Ni/Cu+Soft termination/Ni Barrier/Sn 100%/Open Mode  
※This code has only typical specifications. Please refer to individual specifications.
- 9. PRODUCT CODE** \_\_\_\_\_  
P=Automotive product meet AEC-Q-200.  
※If orders are placed without returned specification, please allow us to judge that specification is accepted by your side.
- 10. GRADE CODE** \_\_\_\_\_  
N=Standard
- 11. PACKAGING CODE** \_\_\_\_\_  
B = Bulk O = Cardboard Tape, 10" Reel E = Embossed Type, 7" Reel  
P = Bulk Case D = Cardboard Tape, 13" Reel(10,000ea) G = Embossed Type, 7" Reel(3,000ea)  
C = Cardboard Tape, 7" Reel L = Cardboard Tape, 13" Reel(15,000ea) F = Embossed Type, 13" Reel  
H = Cardboard Tape, 7" Reel(15,000ea) S = Embossed Type, 10" Reel

**\* Class I**

Symbol	EIA Code	Operation Temperature Range(°C)	Temperature Coefficient Range(ppm/°C)
C	COG	-55 ~ +125	0 ±30

**\*\* Class II**

Symbol	EIA Code	Operation Temperature Range(°C)	Capacitance Change (ΔC %)
B	X7R	-55 ~ +125	0 ±15

**\*\* Capacitance Tolerance**

Code	Capacitance Tolerance	TC	Capacitance Step	Rated Capacitance
C	±0.25 pF	COG	Under 5 pF	E-12 series *
D	±0.5 pF	COG	6.0 to 9.0 pF	E-12 series *
J	±5%	COG	Over 10 pF	E-12 series
K	±10%	X7R	Under 0.01 μF	E-3 series
			Over 0.01 μF	E-6 series
M	±20%	X7R	Under 0.01 μF	E-3 series
			Over 0.01 μF	E-6 series

\*E-24 series is also available

Series	Capacitance Step											
	1.0			2.2			4.7					
E-3	1.0			2.2			4.7					
E-6	1.0	1.5	2.2	3.3	4.7	6.8						
E-12	1.0	1.2	1.5	1.8	2.2	2.7	3.3	3.9	4.7	5.6	6.8	8.2
E-24	1.0	1.1	1.2	1.3	2.2	2.4	2.7	3.0	4.7	5.1	5.6	6.2
	1.5	1.6	1.8	2.0	3.3	3.6	3.9	4.3	6.8	7.5	8.2	9.1

**\*\*\***

Size	Code	Thickness(mm)	Spec(mm) *
0402(1005)	5	0.50	±0.05
0603(1608)	8	0.80	±0.10
0805(2012)	6	0.60	±0.10
	C	0.85	±0.10
	F	1.25	±0.10
	Q	1.25	±0.15
1206(3216)	C	0.85	±0.15
	P	1.15	±0.10
	H	1.60	±0.20

Part Numbering System

General Capacitors

High Capacitance Capacitors

Super Small Size Capacitors

Medium-High Voltage Capacitors

Array Type Capacitors

Low ESL Capacitors

Reliability Test Condition

Premium Capacitors for Automotive Applications

Packaging Specification

Application Manual for Surface Mounting

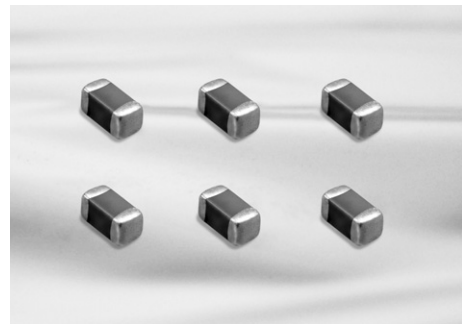

**Feature**

- Automotive products are manufactured in state of the art facilities recommended for registration to ISO/TS 16949:2002.
- Automotive products meet AEC-Q-200 requirements.
- Automotive products are RoHS compliant.
- Samsung terminations are suitable for all flow and reflow soldering systems. (10/21/31 size type only)
- Automotive products meet JEDEC-020-D requirements.
- COG dielectric components contain BME and copper terminations with a Ni/Sn plated overcoat.
- X7R dielectric components have BME and soft terminations with a Ni/Sn plated overcoat.

**Application**

- Automotive Electronic Equipment  
(Powertrain, Safety, Body & Chassis, Convenience, Infotainment)

**Structure and Dimensions**

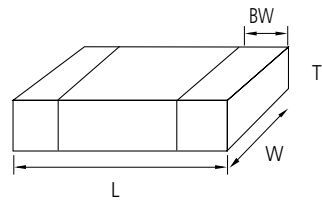

Code	EIA Code	Dimension(mm)			
		L	W	T	BW
05	0402	1.00±0.05	0.50±0.05	0.50(±0.05)	0.25±0.10
10	0603	1.60±0.10	0.80±0.10	0.80(±0.10)	0.3±0.2
21	0805	2.00±0.10	1.25±0.10	0.60(±0.10)	0.5+0.2/-0.3
				0.85(±0.10)	
				1.25(±0.10)	
		2.00±0.15	1.25±0.15	1.25(±0.15)	
31	1206	3.20±0.20	1.60±0.20	0.85(±0.15)	0.5±0.3
				1.15(±0.10)	
				1.60(±0.20)	

**Automotive Capacitors Table (COG, X7R)**

TC	Size(mm)	Thickness (mm)	Vr	Capacitance (pF)			Capacitance (nF)						
				100	220	470	1	2.2	4.7	10	22	47	100
COG	0402(1005)	0.50	50	[Bar]									
			100	[Bar]									
	0603(1608)	0.80	50	[Bar]									
			100	[Bar]			271						
0805(2012)	0.60 0.85 1.25	100	50	[Bar]									
			100	[Bar]									
			100	[Bar]									

TC	Size(mm)	Thickness (mm)	Vr	Capacitance (nF)						Capacitance (μF)				
				10	22	47	100	220	470	1	2.2	4.7	10	
X7R	0402(1005)	0.50	10	[Bar]										
			16	[Bar]										
			25	[Bar]										
			50	[Bar]										
	0603(1608)	0.80	10	[Bar]										
			16	[Bar]										
			25	[Bar]										
			50	[Bar]										
			100	[Bar]										
	0805(2012)	1.25	10	10	[Bar]									
				16	[Bar]									
				16	[Bar]									
0.60		25	10	[Bar]										
			16	[Bar]										
			16	[Bar]										
0.85		50	10	[Bar]										
			16	[Bar]										
			16	[Bar]										
1.25	100	10	[Bar]											
		16	[Bar]											
		16	[Bar]											
1206(3216)	1.60	10	10	[Bar]										
			16	[Bar]										
			16	[Bar]										
	0.85	25	10	[Bar]										
			16	[Bar]										
			16	[Bar]										
	0.85	50	10	[Bar]										
			16	[Bar]										

Part Numbering System

General Capacitors

High Capacitance Capacitors

Super Small Size Capacitors

Medium-High Voltage Capacitors

Array Type Capacitors

Low ESL Capacitors

Reliability Test Condition

Premium Capacitors for Automotive Applications

Packaging Specification

Application Manual for Surface Mounting

Product Lineup (Automotive Capacitors\_COG)

	Part Number	Size L × W (mm)	Capacitance	Rated Voltage (Vdc)	Capacitance Tolerance	Thickness Max. (mm)
1	CL05C4R7CB51PN □	1.00×0.50	4.7pF	50	±0.25pF	0.55
2	CL05C4R7CC51PN □		4.7pF	100	±0.25pF	0.55
3	CL05C6R8DB51PN □		6.8pF	50	±0.5pF	0.55
4	CL05C6R8DC51PN □		6.8pF	100	±0.5pF	0.55
5	CL05C100JB51PN □		10pF	50	±5%	0.55
6	CL05C100JC51PN □		10pF	100	±5%	0.55
7	CL05C120JB51PN □		12pF	50	±5%	0.55
8	CL05C120JC51PN □		12pF	100	±5%	0.55
9	CL05C150JB51PN □		15pF	50	±5%	0.55
10	CL05C150JC51PN □		15pF	100	±5%	0.55
11	CL05C180JB51PN □		18pF	50	±5%	0.55
12	CL05C180JC51PN □		18pF	100	±5%	0.55
13	CL05C220JB51PN □		22pF	50	±5%	0.55
14	CL05C220JC51PN □		22pF	100	±5%	0.55
15	CL05C270JB51PN □		27pF	50	±5%	0.55
16	CL05C270JC51PN □		27pF	100	±5%	0.55
17	CL05C330JB51PN □		33pF	50	±5%	0.55
18	CL05C330JC51PN □		33pF	100	±5%	0.55
19	CL05C390JB51PN □		39pF	50	±5%	0.55
20	CL05C390JC51PN □		39pF	100	±5%	0.55
21	CL05C470JB51PN □		47pF	50	±5%	0.55
22	CL05C470JC51PN □		47pF	100	±5%	0.55
23	CL05C560JB51PN □		56pF	50	±5%	0.55
24	CL05C560JC51PN □		56pF	100	±5%	0.55
25	CL05C680JB51PN □		68pF	50	±5%	0.55
26	CL05C680JC51PN □		68pF	100	±5%	0.55
27	CL05C820JB51PN □		82pF	50	±5%	0.55
28	CL05C820JC51PN □		82pF	100	±5%	0.55
29	CL05C101JB51PN □		100pF	50	±5%	0.55
30	CL05C101JC51PN □		100pF	100	±5%	0.55
31	CL05C121JB51PN □		120pF	50	±5%	0.55
32	CL05C151JB51PN □		150pF	50	±5%	0.55
33	CL05C221JB51PN □		220pF	50	±5%	0.55
1	CL10C4R7CB81PN □	1.60×0.80	4.7pF	50	±0.25pF	0.90
2	CL10C4R7CC81PN □		4.7pF	100	±0.25pF	0.90
3	CL10C6R8DB81PN □		6.8pF	50	±0.5pF	0.90
4	CL10C6R8DC81PN □		6.8pF	100	±0.5pF	0.90
5	CL10C100JB81PN □		10pF	50	±5%	0.90
6	CL10C100JC81PN □		10pF	100	±5%	0.90
7	CL10C120JB81PN □		12pF	50	±5%	0.90
8	CL10C120JC81PN □		12pF	100	±5%	0.90
9	CL10C150JB81PN □		15pF	50	±5%	0.90
10	CL10C150JC81PN □		15pF	100	±5%	0.90
11	CL10C180JB81PN □		18pF	50	±5%	0.90
12	CL10C180JC81PN □		18pF	100	±5%	0.90
13	CL10C220JB81PN □		22pF	50	±5%	0.90
14	CL10C220JC81PN □		22pF	100	±5%	0.90
15	CL10C270JB81PN □		27pF	50	±5%	0.90
16	CL10C270JC81PN □		27pF	100	±5%	0.90
17	CL10C330JB81PN □		33pF	50	±5%	0.90

※ □mark means packaging code. If you want to learn the code or quantity in detail, please see p80.

Product Lineup (Automotive Capacitors\_COG)

	Part Number	Size L × W (mm)	Capacitance	Rated Voltage (Vdc)	Capacitance Tolerance	Thickness Max. (mm)	
18	CL10C330JC81PN □	1.60×0.80	33pF	100	±5%	0.90	
19	CL10C390JB81PN □		39pF	50	±5%	0.90	
20	CL10C390JC81PN □		39pF	100	±5%	0.90	
21	CL10C470JB81PN □		47pF	50	±5%	0.90	
22	CL10C470JC81PN □		47pF	100	±5%	0.90	
23	CL10C560JB81PN □		56pF	50	±5%	0.90	
24	CL10C560JC81PN □		56pF	100	±5%	0.90	
25	CL10C680JB81PN □		68pF	50	±5%	0.90	
26	CL10C680JC81PN □		68pF	100	±5%	0.90	
27	CL10C820JB81PN □		82pF	50	±5%	0.90	
28	CL10C820JC81PN □		82pF	100	±5%	0.90	
29	CL10C101JB81PN □		100pF	50	±5%	0.90	
30	CL10C101JC81PN □		100pF	100	±5%	0.90	
31	CL10C121JB81PN □		120pF	50	±5%	0.90	
32	CL10C151JB81PN □		150pF	50	±5%	0.90	
33	CL10C221JB81PN □		220pF	50	±5%	0.90	
34	CL10C271JB81PN □		270pF	50	±5%	0.90	
35	CL10C331JB81PN □		330pF	50	±5%	0.90	
36	CL10C391JB81PN □		390pF	50	±5%	0.90	
37	CL10C471JB81PN □		470pF	50	±5%	0.90	
38	CL10C561JB81PN □		560pF	50	±5%	0.90	
39	CL10C681JB81PN □		680pF	50	±5%	0.90	
40	CL10C821JB81PN □		820pF	50	±5%	0.90	
41	CL10C821JB81PN □		1.0nF	50	±5%	0.90	
1	CL21C100JB61PN □		2.00×1.25	10pF	50	±5%	0.70
2	CL21C100JC61PN □			10pF	100	±5%	0.70
3	CL21C120JB61PN □			12pF	50	±5%	0.70
4	CL21C120JC61PN □			12pF	100	±5%	0.70
5	CL21C150JB61PN □			15pF	50	±5%	0.70
6	CL21C150JC61PN □			15pF	100	±5%	0.70
7	CL21C180JB61PN □			18pF	50	±5%	0.70
8	CL21C180JC61PN □			18pF	100	±5%	0.70
9	CL21C220JB61PN □			22pF	50	±5%	0.70
10	CL21C220JC61PN □	22pF		100	±5%	0.70	
11	CL21C270JC61PN □	27pF		100	±5%	0.70	
12	CL21C330JB61PN □	33pF		50	±5%	0.70	
13	CL21C330JC61PN □	33pF		100	±5%	0.70	
14	CL21C390JB61PN □	39pF		50	±5%	0.70	
15	CL21C390JC61PN □	39pF		100	±5%	0.70	
16	CL21C470JB61PN □	47pF		50	±5%	0.70	
17	CL21C470JC61PN □	47pF		100	±5%	0.70	
18	CL21C560JB61PN □	56pF		50	±5%	0.70	
19	CL21C560JC61PN □	56pF		100	±5%	0.70	
20	CL21C680JB61PN □	68pF		50	±5%	0.70	
21	CL21C680JC61PN □	68pF		100	±5%	0.70	
22	CL21C820JB61PN □	82pF		50	±5%	0.70	
23	CL21C820JC61PN □	82pF		100	±5%	0.70	
24	CL21C101JB61PN □	100pF		50	±5%	0.70	
25	CL21C101JC61PN □	100pF		100	±5%	0.70	

※ □mark means packaging code. If you want to learn the code or quantity in detail, please see p80.

Part Numbering System

General Capacitors

High Capacitance Capacitors

Super Small Size Capacitors

Medium-High Voltage Capacitors

Array Type Capacitors

Low ESL Capacitors

Reliability Test Condition

Premium Capacitors for Automotive Applications

Packaging Specification

Application Manual for Surface Mounting

Product Lineup (Automotive Capacitors\_COG)

	Part Number	Size L × W (mm)	Capacitance	Rated Voltage (Vdc)	Capacitance Tolerance	Thickness Max. (mm)
26	CL21C121JB61PN □	2.00×1.25	120pF	50	±5%	0.70
27	CL21C121JC61PN □		120pF	100	±5%	0.70
28	CL21C151JB61PN □		150pF	50	±5%	0.70
29	CL21C151JC61PN □		150pF	100	±5%	0.70
30	CL21C221JB61PN □		220pF	50	±5%	0.70
31	CL21C221JC61PN □		220pF	100	±5%	0.70
32	CL21C271JB61PN □		270pF	50	±5%	0.70
33	CL21C271JC61PN □		270pF	100	±5%	0.70
34	CL21C331JB61PN □		330pF	50	±5%	0.70
35	CL21C331JC61PN □		330pF	100	±5%	0.70
36	CL21C471JBC1PN □		470pF	50	±5%	0.95
37	CL21C471JCC1PN □		470pF	100	±5%	0.95
38	CL21C561JBC1PN □		560pF	50	±5%	0.95
39	CL21C561JCC1PN □		560pF	100	±5%	0.95
40	CL21C681JBC1PN □		680pF	50	±5%	0.95
41	CL21C681JCC1PN □		680pF	100	±5%	0.95
42	CL21C821JBC1PN □		820pF	50	±5%	0.95
43	CL21C821JCC1PN □		820pF	100	±5%	0.95
44	CL21C102JBF1PN □		1.0nF	50	±5%	1.35
45	CL21C102JBC1PN □		1.0nF	50	±5%	0.95
46	CL21C102JCF1PN □		1.0nF	100	±5%	1.35
47	CL21C102JCC1PN □		1.0nF	100	±5%	0.95
48	CL21C122JBF1PN □		1.2nF	50	±5%	1.35
49	CL21C122JBC1PN □		1.2nF	50	±5%	0.95
50	CL21C152JBF1PN □		1.5nF	50	±5%	1.35
51	CL21C152JBC1PN □		1.5nF	50	±5%	0.95
52	CL21C182JBF1PN □		1.8nF	50	±5%	1.35
53	CL21C182JBC1PN □		1.8nF	50	±5%	0.95
54	CL21C222JBF1PN □		2.2nF	50	±5%	1.35
55	CL21C222JBC1PN □		2.2nF	50	±5%	0.95
56	CL21C272JBF1PN □		2.7nF	50	±5%	1.35
57	CL21C272JBC1PN □		2.7nF	50	±5%	0.95
58	CL21C332JBF1PN □		3.3nF	50	±5%	1.35
59	CL21C332JBC1PN □		3.3nF	50	±5%	0.95
60	CL21C392JBF1PN □		3.9nF	50	±5%	1.35
61	CL21C392JBC1PN □		3.9nF	50	±5%	0.95
62	CL21C472JBF1PN □		4.7nF	50	±5%	1.35
63	CL21C472JBC1PN □		4.7nF	50	±5%	0.95
64	CL21C562JBF1PN □		5.6nF	50	±5%	1.35
65	CL21C562JBC1PN □		5.6nF	50	±5%	0.95
66	CL21C682JBF1PN □		6.8nF	50	±5%	1.35
67	CL21C822JBF1PN □		8.2nF	50	±5%	1.35
68	CL21C103JBF1PN □		10nF	50	±5%	1.35

※ □ mark means packaging code. If you want to learn the code or quantity in detail, please see p80.

Product Lineup (Automotive Capacitors\_X7R)

	Part Number	Size L × W (mm)	Capacitance	Rated Voltage (Vdc)	Capacitance Tolerance	Thickness Max. (mm)
1	CL05B331KB5VPN □	1.00×0.50	330pF	50	±10%	0.55
2	CL05B471KB5VPN □		470pF	50	±10%	0.55
3	CL05B681KB5VPN □		680pF	50	±10%	0.55
4	CL05B102KA5VPN □		1.0nF	25	±10%	0.55
5	CL05B102KB5VPN □		1.0nF	50	±10%	0.55
6	CL05B152KA5VPN □		1.5nF	25	±10%	0.55
7	CL05B152KB5VPN □		1.5nF	50	±10%	0.55
8	CL05B222KA5VPN □		2.2nF	25	±10%	0.55
9	CL05B222KB5VPN □		2.2nF	50	±10%	0.55
10	CL05B332KA5VPN □		3.3nF	25	±10%	0.55
11	CL05B332KB5VPN □		3.3nF	50	±10%	0.55
12	CL05B472KA5VPN □		4.7nF	25	±10%	0.55
13	CL05B472KB5VPN □		4.7nF	50	±10%	0.55
14	CL05B682KA5VPN □		6.8nF	25	±10%	0.55
15	CL05B682KB5VPN □		6.8nF	50	±10%	0.55
16	CL05B103KA5VPN □		10nF	25	±10%	0.55
17	CL05B103KB5VPN □		10nF	50	±10%	0.55
18	CL05B153KA5VPN □		15nF	25	±10%	0.55
19	CL05B153KB5VPN □		15nF	50	±10%	0.55
20	CL05B223KA5VPN □		22nF	25	±10%	0.55
21	CL05B223KB5VPN □		22nF	50	±10%	0.55
22	CL05B333KO5VPN □		33nF	16	±10%	0.55
23	CL05B473KO5VPN □		47nF	16	±10%	0.55
24	CL05B683KO5VPN □		68nF	16	±10%	0.55
25	CL05B104KO5VPN □		100nF	16	±10%	0.55

※ □ mark means packaging code. If you want to learn the code or quantity in detail, please see p80.

Part Numbering System

General Capacitors

High Capacitance Capacitors

Super Small Size Capacitors

Medium-High Voltage Capacitors

Array Type Capacitors

Low ESL Capacitors

Reliability Test Condition

Premium Capacitors for Automotive Applications

Packaging Specification

Application Manual for Surface Mounting

Product Lineup (Automotive Capacitors\_X7R)

	Part Number	Size L×W (mm)	Capacitance	Rated Voltage (Vdc)	Capacitance Tolerance	Thickness Max. (mm)
1	CL10B221KC8WPN □	1.60×0.80	220pF	100	±10%	0.90
2	CL10B331KC8WPN □		330pF	100	±10%	0.90
3	CL10B471KC8WPN □		470pF	100	±10%	0.90
4	CL10B681KC8WPN □		680pF	100	±10%	0.90
5	CL10B102KB8WPN □		1.0nF	50	±10%	0.90
6	CL10B102KC8WPN □		1.0nF	100	±10%	0.90
7	CL10B152KB8WPN □		1.5nF	50	±10%	0.90
8	CL10B152KC8WPN □		1.5nF	100	±10%	0.90
9	CL10B222KB8WPN □		2.2nF	50	±10%	0.90
10	CL10B222KC8WPN □		2.2nF	100	±10%	0.90
11	CL10B332KB8WPN □		3.3nF	50	±10%	0.90
12	CL10B332KC8WPN □		3.3nF	100	±10%	0.90
13	CL10B472KB8WPN □		4.7nF	50	±10%	0.90
14	CL10B472KC8WPN □		4.7nF	100	±10%	0.90
15	CL10B682KB8WPN □		6.8nF	50	±10%	0.90
16	CL10B682KC8WPN □		6.8nF	100	±10%	0.90
17	CL10B103KB8WPN □		10nF	50	±10%	0.90
18	CL10B103KC8WPN □		10nF	100	±10%	0.90
19	CL10B153KB8WPN □		15nF	50	±10%	0.90
20	CL10B223KB8WPN □		22nF	50	±10%	0.90
21	CL10B333KA8WPN □		33nF	25	±10%	0.90
22	CL10B333KB8WPN □		33nF	50	±10%	0.90
23	CL10B473KA8WPN □		47nF	25	±10%	0.90
24	CL10B473KB8WPN □		47nF	50	±10%	0.90
25	CL10B683KA8WPN □		68nF	25	±10%	0.90
26	CL10B683KB8WPN □		68nF	50	±10%	0.90
27	CL10B104KA8WPN □		100nF	25	±10%	0.90
28	CL10B104KB8WPN □		100nF	50	±10%	0.90
29	CL10B154KO8VPN □		150nF	16	±10%	0.90
30	CL10B154KA8VPN □		150nF	25	±10%	0.90
31	CL10B224KO8VPN □		220nF	16	±10%	0.90
32	CL10B224KA8VPN □		220nF	25	±10%	0.90
33	CL10B334KO8VPN □		330nF	16	±10%	0.90
34	CL10B334KA8VPN □		330nF	25	±10%	0.90
35	CL10B474KO8VPN □		470nF	16	±10%	0.90
36	CL10B474KA8VPN □		470nF	25	±10%	0.90
37	CL10B684KO8VPN □		680nF	16	±10%	0.90
38	CL10B105KO8VPN □		1.0μF	16	±10%	0.90

※ □mark means packaging code. If you want to learn the code or quantity in detail, please see p80.

Product Lineup (Automotive Capacitors\_X7R)

	Part Number	Size L×W (mm)	Capacitance	Rated Voltage (Vdc)	Capacitance Tolerance	Thickness Max. (mm)
1	CL21B102KC6WPN □	2.00×1.25	1.0nF	100	±10%	0.70
2	CL21B152KC6WPN □		1.5nF	100	±10%	0.70
3	CL21B222KC6WPN □		2.2nF	100	±10%	0.70
4	CL21B332KC6WPN □		3.3nF	100	±10%	0.70
5	CL21B472KC6WPN □		4.7nF	100	±10%	0.70
6	CL21B682KC6WPN □		6.8nF	100	±10%	0.70
7	CL21B103KC6WPN □		10nF	100	±10%	0.70
8	CL21B153KC6WPN □		15nF	100	±10%	0.70
9	CL21B223KC6WPN □		22nF	100	±10%	0.70
10	CL21B333KCCWPN □		33nF	100	±10%	0.95
11	CL21B473KCCWPN □		47nF	100	±10%	0.95
12	CL21B683KCCWPN □		68nF	100	±10%	0.95
13	CL21B104KBFWPN □		100nF	50	±10%	1.35
14	CL21B104KBCWPN □		100nF	50	±10%	0.95
15	CL21B104KCFWPN □		100nF	100	±10%	1.35
16	CL21B104KCCWPN □		100nF	100	±10%	0.95
17	CL21B154KAFVPN □		150nF	25	±10%	1.35
18	CL21B154KBFVPN □		150nF	50	±10%	1.35
19	CL21B224KAFVPN □		220nF	25	±10%	1.35
20	CL21B224KBFVPN □		220nF	50	±10%	1.35
21	CL21B334KAFVPN □		330nF	25	±10%	1.35
22	CL21B334KBFVPN □		330nF	50	±10%	1.35
23	CL21B474KOFVPN □		470nF	16	±10%	1.35
24	CL21B474KAFVPN □		470nF	25	±10%	1.35
25	CL21B474KBFVPN □		470nF	50	±10%	1.35
26	CL21B684KOFVPN □		680nF	16	±10%	1.35
27	CL21B684KAFVPN □		680nF	25	±10%	1.35
28	CL21B105KOFVPN □		1.0μF	16	±10%	1.35
29	CL21B105KAFVPN □		1.0μF	25	±10%	1.35
30	CL21B225KPFVPN □		2.2μF	10	±10%	1.35
31	CL21B225KOFVPN □		2.2μF	16	±10%	1.35
32	CL21B335KPQVPN □		3.3μF	10	±10%	1.40
33	CL21B475KPQVPN □		4.7μF	10	±10%	1.40
1	CL31B104KBPWPN □	3.20×1.60	100nF	50	±10%	1.25
2	CL31B104KBCVPN □		100nF	50	±10%	1.00
3	CL31B154KBPWPN □		150nF	50	±10%	1.25
4	CL31B224KBPWPN □		220nF	50	±10%	1.25
5	CL31B334KBHWPN □		330nF	50	±10%	1.80
6	CL31B474KBHWPN □		470nF	50	±10%	1.80
7	CL31B684KBHWPN □		680nF	50	±10%	1.80
8	CL31B105KAPWPN □		1.0μF	25	±10%	1.25
9	CL31B105KBHWPN □		1.0μF	50	±10%	1.80
10	CL31B155KAHVPN □		1.5μF	25	±10%	1.80
11	CL31B155KBHVPN □		1.5μF	50	±10%	1.80
12	CL31B225KOHVPN □		2.2μF	16	±10%	1.80
13	CL31B225KAHVPN □		2.2μF	25	±10%	1.80
14	CL31B225KBHVPN □		2.2μF	50	±10%	1.80
15	CL31B335KOHVPN □		3.3μF	16	±10%	1.80
16	CL31B335KAHVPN □		3.3μF	25	±10%	1.80
17	CL31B475KOHVPN □		4.7μF	16	±10%	1.80
18	CL31B475KAHVPN □		4.7μF	25	±10%	1.80

※ □mark means packaging code. If you want to learn the code or quantity in detail, please see p80.

Part Numbering System

General Capacitors

High Capacitance Capacitors

Super Small Size Capacitors

Medium-High Voltage Capacitors

Array Type Capacitors

Low ESL Capacitors

Reliability Test Condition

Premium Capacitors for Automotive Applications

Packaging Specification

Application Manual for Surface Mounting

**Reliability Test Condition (Automotive Capacitors)**

No	Item	Performance	Test Condition	
1	Pre-and Post-Stress Electrical Test	-		
2	High Temperature Exposure	Appearance	No abnormal exterior appearance Unpowered, 1000hrs@T=150°C Measurement at 24±2hrs after test conclusion	
		Capacitance Change	CLASS I	Within ±2.5% or 0.25pF, (Whichever is larger)
			CLASS II	Within ±10%
		Q	CLASS I	Capacitance ≥ 30pF : Q ≥ 1,000 < 30pF : Q ≥ 400 + 20 × C (C : Capacitance)
		Tanδ	CLASS II	Rated Voltage ≥ 25V : 0.03 max ≥ 16V : 0.05 max ≥ 10V : 0.075 max *1)
IR		More than 10,000 μΩ or 500 μΩ × μF (Whichever is smaller) *1)		
3	Temperature Cycling	Appearance	No abnormal exterior appearance 1000Cycles Measurement at 24±2hrs after test conclusion	
		Capacitance Change	CLASS I	Within ±2.5% or 0.25pF, (Whichever is larger)
			CLASS II	Within ±10%
		Q	CLASS I	Capacitance ≥ 30pF : Q ≥ 1,000 < 30pF : Q ≥ 400 + 20 × C (C : Capacitance)
		Tanδ	CLASS II	Rated Voltage ≥ 25V : 0.03 max ≥ 16V : 0.05 max ≥ 10V : 0.075max *1)
IR		More than 10,000 μΩ or 500 μΩ × μF (Whichever is smaller) *1)		
4	Destructive Physical Analysis	No defects or abnormalities	Per EIA 469	
5	Moisture Resistance	Appearance	No abnormal exterior appearance 10Cycles, t=24hrs/cycle Heat (25~65°C) and humidity (80~98%), Unpowered measurement at 24±2hrs after test conclusion	
		Capacitance Change	CLASS I	Within ±2.5% or 0.25pF, (Whichever is larger)
			CLASS II	Within ±12.5%
		Q	CLASS I	Capacitance ≥ 30pF : Q ≥ 350 10≤Capacitance<30pF : Q ≥ 275+(5/2) × C Capacitance < 10pF : Q ≥ 200+10 × C (C : Capacitance)
		Tanδ	CLASS II	Rated Voltage ≥ 25V : 0.03 max ≥ 16V : 0.05 max ≥ 10V : 0.075max *1)
IR		More than 10,000 μΩ or 500 μΩ × μF (Whichever is smaller) *1)		

Step	Temperature(°C)	Time(min.)
1	Min. operating Temp. ±2	15 ± 3
2	25 ± 2	1
3	Max. operating Temp. ±2	15 ± 3
4	25 ± 2	1

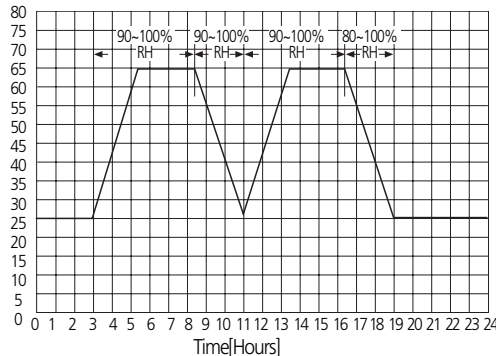

※ \*1) : Indicates typical specification. Please refer to individual specifications.

No	Item	Performance	Test Condition	
6	Biased Humidity	Appearance	No abnormal exterior appearance 1000hrs 85°C/85%RH, Rated Voltate and 1.3~1.5V, (add 100kohm resistor) Measurement at 24±2hrs after test conclusion The charge/discharge current is less than 50mA.	
		Capacitance Change	CLASS I	Within ±2.5% or 0.25pF, (Whichever is larger)
			CLASS II	Within ±12.5%
		Q	CLASS I	Capacitance ≥ 30pF : Q ≥ 200 < 30pF : Q ≥ 100 + (10/3) × C (C : Capacitance)
		Tanδ	CLASS II	Rated Voltage ≥ 25V : 0.035 max ≥ 16V : 0.05 max ≥ 10V : 0.075max *1)
IR		More than 500 μΩ or 25 μΩ × μF (Whichever is Smaller) *1)		
7	High Temperature Operating Life	Appearance	No abnormal exterior appearance 1000hrs @ TA=125°C, 200% Rated Voltage, *2) Measurement at 24±2hrs after test conclusion The charge/discharge current is less than 50mA.	
		Capacitance Change	CLASS I	Within ±3.0% or 0.3pF, (Whichever is larger)
			CLASS II	Within ±12.5%
		Q	CLASS I	Capacitance ≥ 30pF : Q ≥ 350 ≥ 10pF : Q ≥ 275+(5/2) × C < 10pF : Q ≥ 200+10 × C (C : Capacitance)
		Tanδ	CLASS II	Rated Voltage ≥ 25V : 0.035 max ≥ 16V : 0.05 max ≥ 10V : 0.075max *1)
IR		More than 1,000 μΩ or 50 μΩ × μF (Whichever is smaller) *1)		
8	External Visual	No abnormal exterior appearance	Microscope (x10)	
9	Physical Dimensions	Within the specified dimensions	Using the calipers	
10	Mechanical Shock	Appearance	No abnormal exterior appearance Three shocks in each direction should be applied along 3 mutually perpendicular axes of the test specimen (18 shocks)	
		Capacitance Change	CLASS I	Within ±2.5% or 0.25pF, (Whichever is larger)
			CLASS II	Within ±10%
		Q	CLASS I	Capacitance ≥ 30pF : Q ≥ 1,000 < 30pF : Q ≥ 400 + 20 × C (C : Capacitance)
		Tanδ	CLASS II	Rated Voltage ≥ 25V : 0.025 max ≥ 16V : 0.035 max ≥ 10V : 0.05max *1)
IR		More than 10,000 μΩ or 500 μΩ × μF (Whichever is smaller) *1)		

※ \*1) : Indicates typical specification. Please refer to individual specifications.

\*2) : Some of the parts are applicable in rated voltage x 150%, Please refer to individual specifications.

Peakvalue	Duration	Wave
1,500G	0.5ms	Half sine

- Part Numbering System
- General Capacitors
- High Capacitance Capacitors
- Super Small Size Capacitors
- Medium-High Voltage Capacitors
- Array Type Capacitors
- Low ESL Capacitors
- Reliability Test Condition
- Premium Capacitors for Automotive Applications
- Packaging Specification
- Application Manual for Surface Mounting

No	Item		Performance	Test Condition	
11	Vibration	Appearance	No abnormal exterior appearance	5g's for 20min., 12cycles each of 3 orientations, Use 8" x5" PCB 0.031" Thick 7 secure points on one long side and 2 secure points at corners of opposite sides. Parts mounted within 2" from any secure point. Test from 10~2000 Hz.	
		Capacitance Change	CLASS I		Within ±2.5% or 0.25pF, (Whichever is larger)
			CLASS II		Within ±10%
		Q	CLASS I		Capacitance ≥ 30pF : Q ≥ 1,000 < 30pF : Q ≥ 400+20×C (C : Capacitance)
		Tanδ	CLASS II		Rated Voltage ≥ 25V : 0.025 max ≥ 16V : 0.035 max ≥ 10V : 0.05max *1)
IR		More than 10,000 μΩ or 500 μΩ × μF (Whichever is smaller) *1)			
12	Resistance to Solder Heat	Appearance	No abnormal exterior appearance	Solder pot : 260 ± 5°C, 10 ± 1sec.	
		Capacitance Change	CLASS I		Within ±2.5% or 0.25pF, (Whichever is larger)
			CLASS II		Within ±10%
		Q	CLASS I		Capacitance ≥ 30pF : Q ≥ 1,000 < 30pF : Q ≥ 400+20×C (C : Capacitance)
		Tanδ	CLASS II		Rated Voltage ≥ 25V : 0.025 max ≥ 16V : 0.035 max ≥ 10V : 0.05max *1)
IR		More than 10,000 μΩ or 500 μΩ × μF (Whichever is smaller) *1)			
13	Thermal Shock	Appearance	No abnormal exterior appearance	-55°C/+125°C Note: Number of cycles required - 300, Maximum transfer time-20 sec, Dwell time-15min. Air-Air	
		Capacitance Change	CLASS I		Within ±2.5% or 0.25pF, (Whichever is larger)
			CLASS II		Within ±10%
		Q	CLASS I		Capacitance ≥ 30pF : Q ≥ 1,000 < 30pF : Q ≥ 400+20×C (C : Capacitance)
		Tanδ	CLASS II		Rated Voltage ≥ 25V : 0.025 max ≥ 16V : 0.035 max ≥ 10V : 0.05max *1)
IR		More than 10,000 μΩ or 500 μΩ × μF (Whichever is smaller) *1)			
14	ESD	Appearance	No abnormal exterior appearance	AEC-Q200-002	
		Capacitance Change	CLASS I		Within ±2.5% or 0.25pF, (Whichever is larger)
			CLASS II		Within ±10%
		Q	CLASS I		Capacitance ≥ 30pF : Q ≥ 1,000 < 30pF : Q ≥ 400+20×C (C : Capacitance)
		Tanδ	CLASS II		Rated Voltage ≥ 25V : 0.025 max ≥ 16V : 0.035 max ≥ 10V : 0.05max *1)
IR		More than 10,000 μΩ or 500 μΩ × μF (Whichever is smaller) *1)			

※ \*1) : Indicates typical specification. Please refer to individual specifications.

No	Item		Performance	Test Condition																			
15	Solderability		95% of the terminations is to be soldered evenly and continuously	a) Preheat at 155°C for 4 hours, Immerse in solder for 5s at 235 ± 5°C b) Steam aging for 8 hours, Immerse in solder for 5s at 235 ± 5°C c) Steam aging for 8 hours, Immerse in solder for 120s at 260 ± 5°C solder : a solution ethanol and rosin																			
16	Electrical Characterization	Capacitance	Within specified tolerance	The Capacitance /D.F. should be measured at 25°C, I.R. should be measured with a DC voltage not exceeding Rated Voltage @25°C, @125°C for 60~120 sec. Dielectric Strength : 250% of the rated voltage for 1~5 seconds The charge/discharge current is less than 50mA.																			
		Q	CLASS I		Capacitance ≥ 30pF : Q ≥ 1,000 < 30pF : Q ≥ 400+20×C (C : Capacitance)																		
			CLASS II		Rated Voltage ≥ 25V : 0.025 max ≥ 16V : 0.035 max ≥ 10V : 0.05max *1)																		
		IR@25°C	CLASS I		More than 100,000 μΩ or 1,000 μΩ × μF (Whichever is smaller)																		
			CLASS II		More than 10,000 μΩ or 500 μΩ × μF (Whichever is smaller)																		
IR@125°C	CLASS I	More than 10,000 μΩ or 100 μΩ × μF (Whichever is smaller)																					
	CLASS II	More than 1,000 μΩ or 10 μΩ × μF (Whichever is smaller)																					
Dielectric Strength		No dielectric breakdown or mechanical breakdown																					
17	Board Flex	Appearance	No abnormal exterior appearance	Bending to the limit for 5 seconds Limit : Class I - 3mm Class II - 2mm																			
		Capacitance Change	CLASS I		Within ±5.0% or 0.5pF, (Whichever is larger)																		
CLASS II	Within ±10%																						
18	Terminal Strength(SMD)	Appearance	No abnormal exterior appearance	18N, for 60 ± 1 sec. * 0603(1608) -10N, 0402(1005) -2N																			
		Capacitance Change	CLASS I		Within ±2.5% or 0.25pF, (Whichever is larger)																		
CLASS II	Within ±10%																						
19	Beam Load		Destruction value should be exceed Chip Length ≤ 2.5mm a) Chip Thickness > 0.5mm : 20N b) Chip Thickness ≤ 0.5mm : 8N Chip Length ≥ 3.2mm a) Chip Thickness ≥ 1.25mm : 54.5N b) Chip Thickness < 1.25mm : 15N	Beam speed Chip Length ≤ 2.5mm, 0.5 ± 0.05 mm/sec Chip Length ≥ 3.2mm, 2.5 ± 0.25 mm/sec																			
20	Capacitance Temperature Characteristics	Capacitance Change	CLASS I	0 ± 30 ppm/°C	<table border="1"> <thead> <tr> <th>Step</th> <th>Temperature(°C)</th> <th>Time(min)</th> </tr> </thead> <tbody> <tr> <td>1</td> <td>25 ± 2</td> <td>1</td> </tr> <tr> <td>2</td> <td>Min. Operating Temp. ± 2</td> <td>15 ± 3</td> </tr> <tr> <td>3</td> <td>25 ± 2</td> <td>1</td> </tr> <tr> <td>4</td> <td>Max. Operating Temp. ± 2</td> <td>15 ± 3</td> </tr> <tr> <td>5</td> <td>25 ± 2</td> <td>1</td> </tr> </tbody> </table>	Step	Temperature(°C)	Time(min)	1	25 ± 2	1	2	Min. Operating Temp. ± 2	15 ± 3	3	25 ± 2	1	4	Max. Operating Temp. ± 2	15 ± 3	5	25 ± 2	1
			Step	Temperature(°C)		Time(min)																	
		1	25 ± 2	1																			
		2	Min. Operating Temp. ± 2	15 ± 3																			
3	25 ± 2	1																					
4	Max. Operating Temp. ± 2	15 ± 3																					
5	25 ± 2	1																					
CLASS II	Within ±15%																						
Temperature Coefficient	CLASS I	0 ± 30 ppm/°C																					
	Capacitance Drift	CLASS I	Within ±0.2% or 0.05pF, (Whichever is larger)																				

※ \*1) : Indicates typical specification. Please refer to individual specifications.

\*If you want more detailed information, Please Visit Samsung Electro-mechanics website ( www.sem1cr.com )

Part Numbering System

General Capacitors

High Capacitance Capacitors

Super Small Size Capacitors

Medium-High Voltage Capacitors

Array Type Capacitors

Low ESL Capacitors

Reliability Test Condition

Premium Capacitors for Automotive Applications

Packaging Specification

Application Manual for Surface Mounting

## Cardboard Paper Tape(4mm)

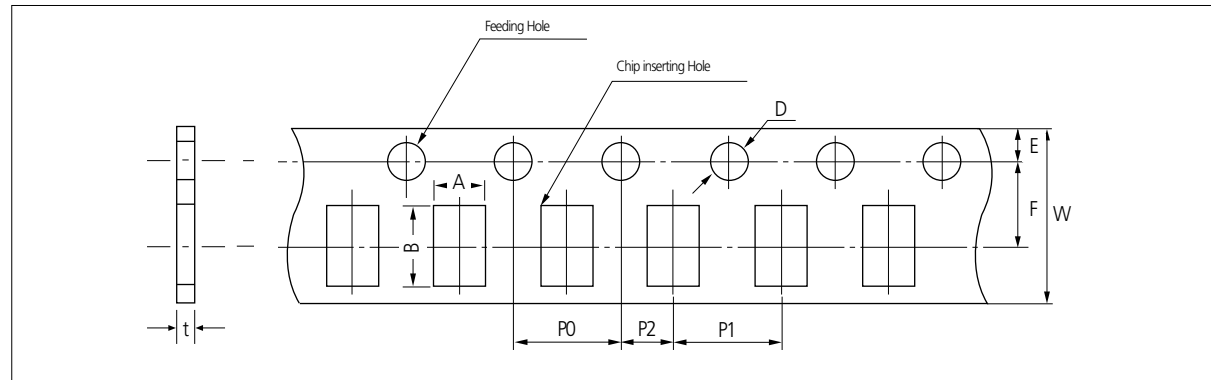

Unit: inch(mm)

Symbol Type	A	B	W	F	E	P1	P2	P0	D	t	
	Dimension	0504 (1410)	1.3 ±0.2	1.7 ±0.2	8.0 ±0.3	3.5 ±0.05	1.75 ±0.1	4.0 ±0.1	2.0 ±0.05	4.0 ±0.1	Ø1.5 +0.1/-0
0603 0306 (1608) (0816)		1.1 ±0.2	1.9 ±0.2								
0805 0508 (2012) (1220)		1.6 ±0.2	2.4 ±0.2								
1206 0612 (3216) (1632)		2.0 ±0.2	3.6 ±0.2								

## Cardboard Paper Tape(2mm)

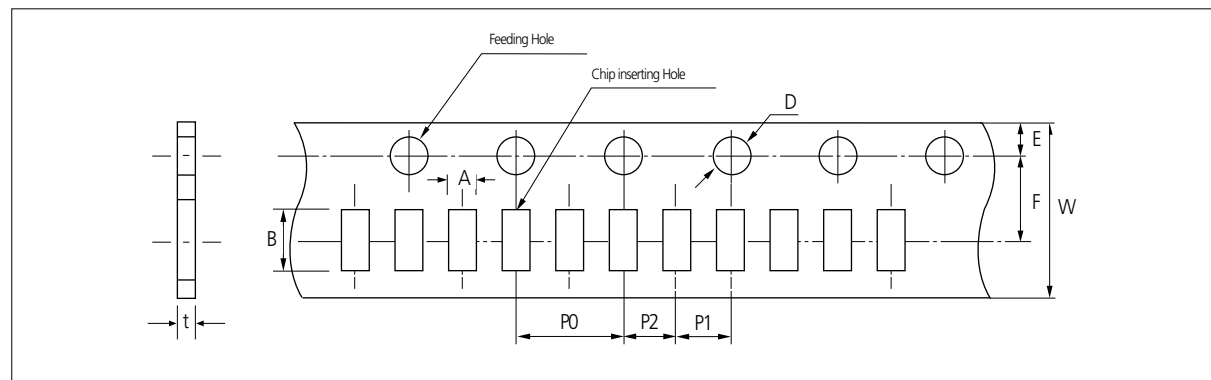

Unit: inch(mm)

Symbol Type	A	B	W	F	E	P1	P2	P0	D	t	
	Dimension	01005 (0402)	0.25 ±0.02	0.45 ±0.02	8.0 ±0.3	3.5 ±0.05	1.75 ±0.1	2.0 ±0.05	2.0 ±0.05	4.0 ±0.1	Ø1.5 +0.1/-0.03
0201 (0603)		0.38 ±0.03	0.68 ±0.03	0.37 ±0.03							
0402 (1005)		0.62 ±0.05	1.12 ±0.05	0.37 ±0.05							
				0.60 ±0.05							
0204 (0510)		0.62 +0.05/-0.10	1.12 +0.05/-0.10	0.37 ±0.03							

## Embossed Plastic Tape

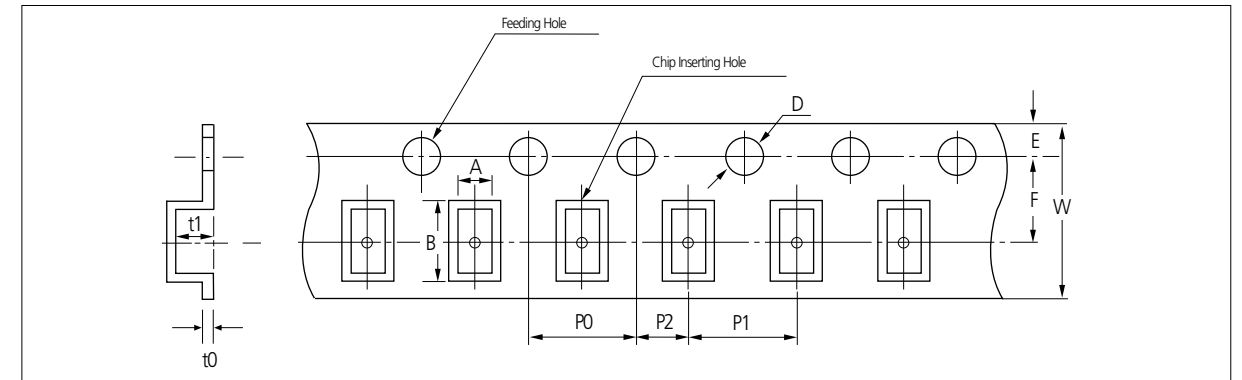

Unit: inch(mm)

Symbol Type	A	B	W	F	E	P1	P2	P0	D	t1	t0	
	Dimension	01005 (0402)	0.25 ±0.02	0.45 ±0.02	4.0 ±0.05	1.8 ±0.02	0.9 ±0.05	1.0 ±0.02	1.0 ±0.02	2.0 ±0.04	Ø0.8 ±0.04	0.25 ±0.02
0603 (1608)		1.05 ±0.15	1.9 ±0.15	8.0 ±0.3	3.5 ±0.05	4.0 ±0.1	2.0 ±0.05	4.0 ±0.1	Ø1.5 +0.1/-0.03	2.9 max	0.6 Below	
0805 (2012)		1.45 ±0.2	2.3 ±0.2									
1206 (3216)		1.9 ±0.2	3.5 ±0.2									
1210 (3225)		2.8 ±0.2	3.6 ±0.2									
1808 (4520)		2.3 ±0.2	4.9 ±0.2	12.0 ±0.3	5.60 ±0.05	1.75 ±0.1	8.0 ±0.1	2.0 ±0.05	4.0 ±0.1	3.8 max		
1812 (4532)		3.6 ±0.2	4.9 ±0.2									
2220 (5750)		5.5 ±0.2	6.2 ±0.2									
0204 (5010)		0.62 +0.05/-0.10	1.12 +0.05/-0.10	0.8 ±0.3	3.5 ±0.05	4.0 ±0.1	2.0 ±0.05	4.0 ±0.1	Ø1.5 +0.1/-0.03	2.5 max		
0306 (0816)		1.1 ±0.2	1.9 ±0.2									
0508 (1220)		1.45 ±0.2	2.3 ±0.2									
0612 (1632)		2.0 ±0.2	3.6 ±0.2									

## Peeling off of Cover Tape

• 5 g.f ≤ Peel off force ≤ 70 g.f

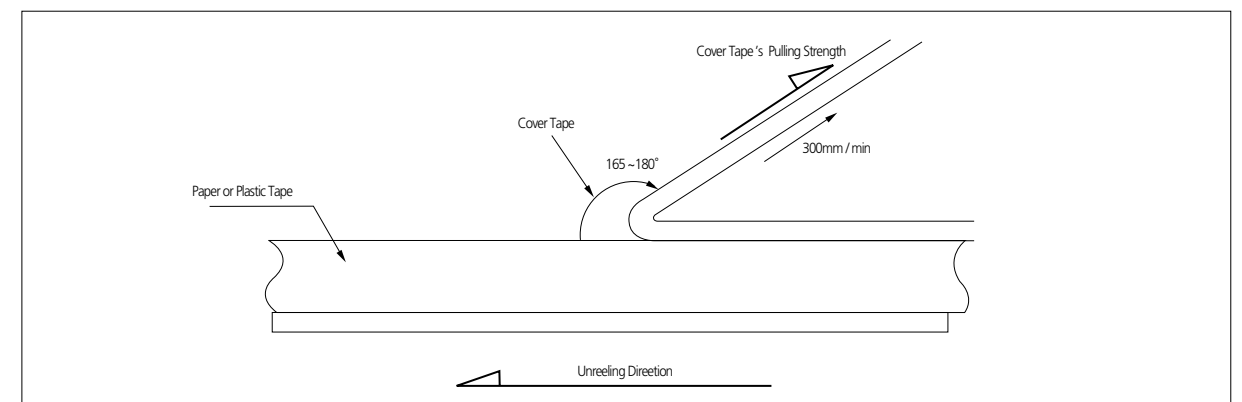

Part Numbering System

General Capacitors

High Capacitance Capacitors

Super Small Size Capacitors

Medium-High Voltage Capacitors

Array Type Capacitors

Low ESL Capacitors

Reliability Test Condition

Premium Capacitors for Automotive Applications

Packaging Specification

Application Manual for Surface Mounting



**Taping Size**

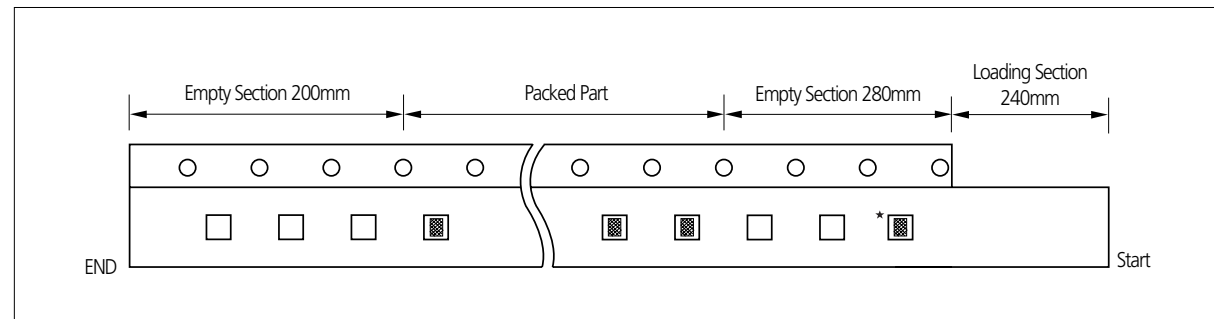

• The chip is only use for identifying the label and packaged products. Please don't use the chip.

Unit: kpcs

Size	T code	Quantity & Packing Code								
		Cardboard Paper Type					Embossed Plastic Type			
		C (7"reel)	H (7"reel)	O (10"reel)	D (13"reel)	L (13"reel)	E (7"reel)	G (7"reel)	F (13"reel)	S (10"reel)
01005(0402)	2	20	-	-	100	-	50	-	-	-
0201(0603)	3	10	15	30	50	-	-	-	-	-
0402(1005)	3	10	15	30	50	-	-	-	-	-
	5	10	15	30	50	40	-	-	-	-
0504(1410)	8	4	-	10	10	15	-	-	-	-
0603(1608)	5	4	-	10	10	-	-	-	-	-
	8	4	-	10	10	15	3	-	-	-
0604(1610)	D	-	-	-	-	-	3	-	10	6
0805(2012)	A, C	4	-	10	10	15	-	-	-	-
	E, F, Q	-	-	-	-	-	2	3	10	6
1206(3216)	C	4	-	10	10	15	-	-	-	-
	E, F, P	-	-	-	-	-	2	3	10	6
	H	-	-	-	-	-	2	-	8	4
1210(3225)	9, D, C, O	-	-	-	-	-	2	-	10	-
	E, F, M	-	-	-	-	-	2	-	10	-
	H, T	-	-	-	-	-	2	-	8	4
	I, U	-	-	-	-	-	2	-	4	-
	J, V	-	-	-	-	-	1	-	4	-
1808(4520)	S	-	-	-	-	-	2	-	8	-
	F	-	-	-	-	-	2	-	-	-
1812(4532)	F, H, I	-	-	-	-	-	1	-	4	-
	L, J	-	-	-	-	-	-	-	2	-
2220(5750)	H, I, J	-	-	-	-	-	-	-	2	-

**Reel Dimensions**

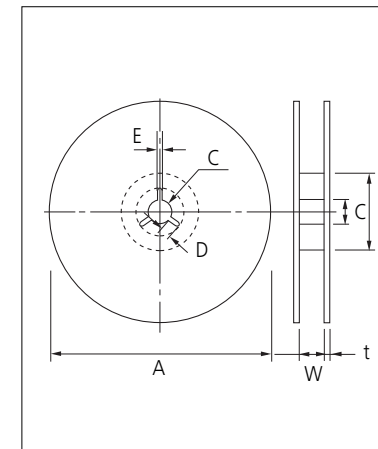

Unit: mm

Symbol	Tape Width	A	B	C	D
7" Reel	8mm	Ø180+0/-3	Ø60±1.0	Ø13±0.3	4±0.2
	12mm	Ø180+0/-3	Ø60+1/-0	Ø13±0.3	4±0.2
10" Reel	8mm	Ø258+0/-3	Ø80+1/-0	Ø13±0.3	4±0.2
	12mm	Ø258+0/-3	Ø80+1/-0	Ø13±0.3	4±0.2
13" Reel	8mm	Ø330±2.0	Ø80±1.0	Ø13±0.3	4±0.2
	12mm	Ø330±2.0	Ø80±1.0	Ø13±0.3	4±0.2

Symbol	Tape Width	E	W	t
7" Reel	8mm	2.0±0.5	9±0.5	1.2±0.2
	12mm	2.0±0.5	13±0.5	1.2±0.2
10" Reel	8mm	2.0±0.5	9±0.5	1.8±0.2
	12mm	2.0±0.5	13±0.5	1.8±0.2
13" Reel	8mm	2.0±0.5	9±0.5	2.2±0.2
	12mm	2.0±0.5	13±0.5	2.2±0.2

**Bulk Case Packaging**

- Bulk case packaging can reduce the stock space and transportation costs.
- The bulk feeding system can increase the productivity.
- It can eliminate the components loss.

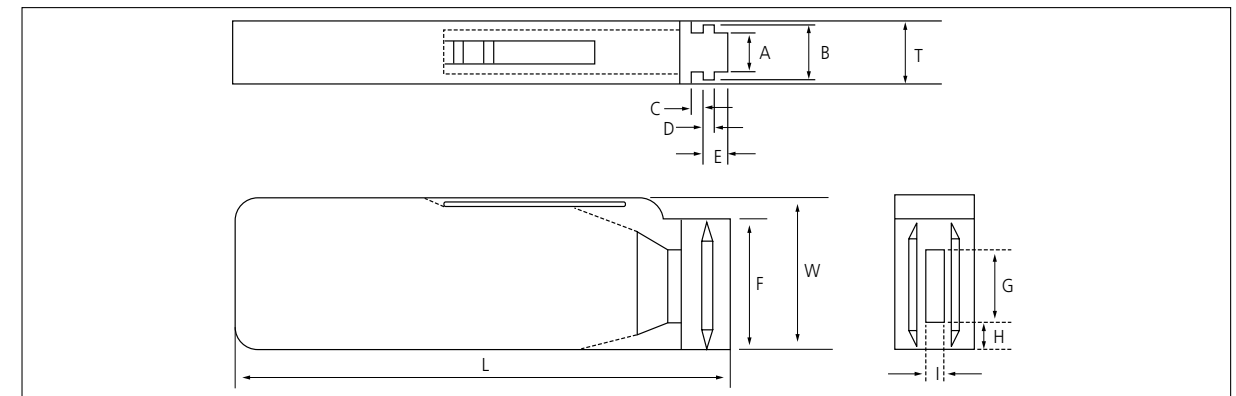

Unit: mm

Symbol	A	B	T	C	D	E
Dimension	6.8±0.1	8.8±0.1	12±0.1	1.5+0.1/-0	2+0/-0.1	3.0+0.2/-0

Symbol	F	W	G	H	L	I
Dimension	31.5+0.2/-0	36+0/-0.2	19±0.35	7±0.35	110±0.7	5±0.35

**• QUANTITY**

Unit: inch(mm) and pcs

Size	0402(1005)	0603(1608)	0805(2012)	
			T≤0.85mm	T≥1.0mm
Quantity	50,000	10,000 or 15,000	10,000	5,000

Part Numbering System

General Capacitors

High Capacitance Capacitors

Super Small Size Capacitors

Medium-High Voltage Capacitors

Array Type Capacitors

Low ESL Capacitors

Reliability Test Condition

Premium Capacitors for Automotive Applications

Packaging Specification

Application Manual for Surface Mounting

## 1. Storage of products

### 1-1. Storage Environment

Tape packing materials are designed to withstand long-term storage, but they will degrade more rapidly in the presence of high temperature or high humidity. Therefore, the products must be stored in an ambient 5~40°C with a relative humidity of 20~70%. Allowable storage period is within 6 months from the outgoing date of delivery.

### 1-2. Corrosive Gases

Since sulfur and chlorine may degrade the solderability of the end termination, it is important to store the capacitors in an environment free of these gases

### 1-3. Temperature Fluctuations

Since dew condensation may occur by the differences in temperature when the products are taken out of storage, it is important to maintain a temperature-controlled environment.

## 2. Design of Solder Land Pattern

When designing printed circuit boards, the shape and size of the solder lands must allow for the proper amount of solder on the capacitor. The amount of solder at the end terminations has a direct effect on the probability that the chip will crack. The greater amount of solder, the larger amount of stress on the chip, and the more likely that it will break. Use the following illustrations as guidelines for proper Solder land design.

Recommendation of solder Land Shape and Size

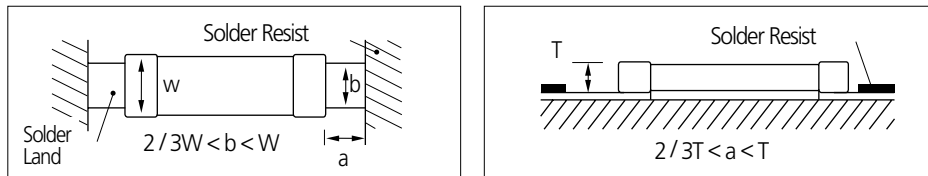

## 3. Adhesives

MLCCs generally require the use of an adhesive to position the chips to the circuit board prior to soldering.

### 3-1. Requirements for Adhesives

- They must have enough adhesion so that the chips will not fall off or move during the handling of the circuit board.
- They must maintain their adhesive strength when exposed to soldering temperatures.
- They should not spread or run when applied to the circuit board.
- They should have a long pot life.
- They should harden quickly.
- They should not corrode the circuit board or chip material.
- They should be a good insulator.
- They should be non-toxic, and not produce harmful gases, nor be harmful when touched.

### 3-2. Application Method

It is important to use the proper amount of adhesive. Too little will cause poor adhesion to the circuit board, and too much may strain the conductor pattern, thereby causing defective soldering. The following illustrations show the proper quantity of adhesive.

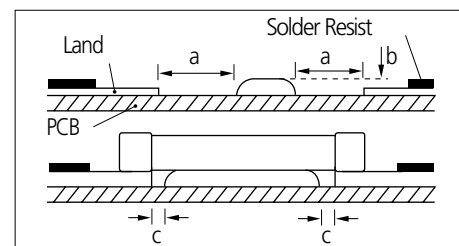

### 3-3. Adhesive hardening Characteristics

To prevent oxidation of the terminations, the adhesive must harden at 160°C or less, within 2 minutes or less.

Unit: mm

Type	21	31
a	0.2min	0.2min
b	70~100μm	70~100μm
c	>0	>0

## 4. Mounting

### 4-1. Mounting Head Pressure

Excessive pressure will cause chip capacitors to crack. The pressure between nozzle and chip capacitor will be 300g maximum during mounting.

### 4-2. Bending Stress

Bending of printed circuit board by mounting head when double-sided circuit boards are used, chip capacitors first are mounted and soldered onto one side of the board. When the capacitors are mounted onto the other side, it is important to support the board as shown in the illustration. If the circuit board is not supported, it may bend, causing the already-installed capacitors to crack.

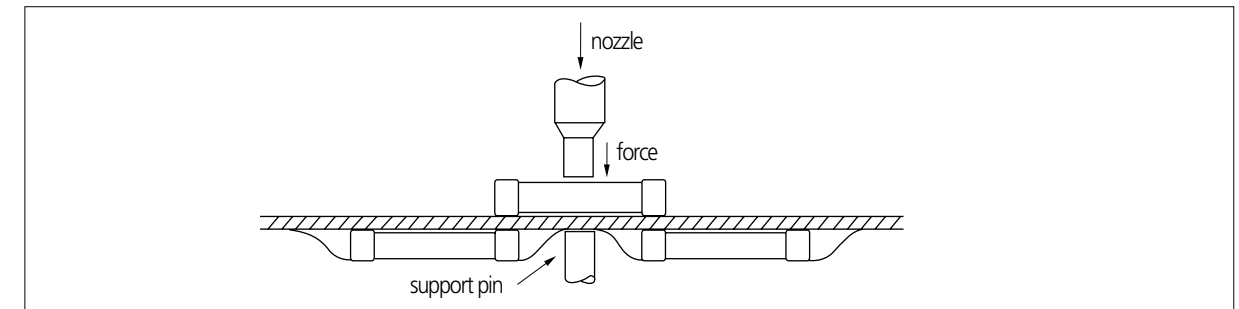

## 5. Flux

Although highly-activated flux gives better solderability, substances which increase activity may also degrade the insulation of the chip capacitors. To avoid such degradation, it is recommended that a mildly activated rosin flux (less than 0.2% chlorine) be used.

## 6. Soldering

Since a multilayer ceramic chip capacitor comes into direct contact with melted solder during soldering, it is exposed to potentially mechanical stress caused by the sudden temperature change. The capacitor may also be subject to silver migration, and to contamination by the flux. Because of these factors, soldering technique is critical.

### 6-1. Soldering Methods

Method	Classification	
Reflow soldering	· Overall heating	· Infrared rays · Hot plate · VPS (Vapor phase)
	· Local heating	· Air heater · Laser · Light beam
Flow Soldering	· Single wave · Double wave	

### 6-2. Soldering Profile

To avoid the crack problem by sudden temperature change, follow the temperature profile in the adjacent graph.

Part Numbering System

General Capacitors

High Capacitance Capacitors

Super Small Size Capacitors

Medium-High Voltage Capacitors

Array Type Capacitors

Low ESL Capacitors

Reliability Test Condition

Premium Capacitors for Automotive Applications

Packaging Specification

Application Manual for Surface Mounting

6-2-1 Pb-Free (Sn 100%) Plating

REFLOW SOLDERING

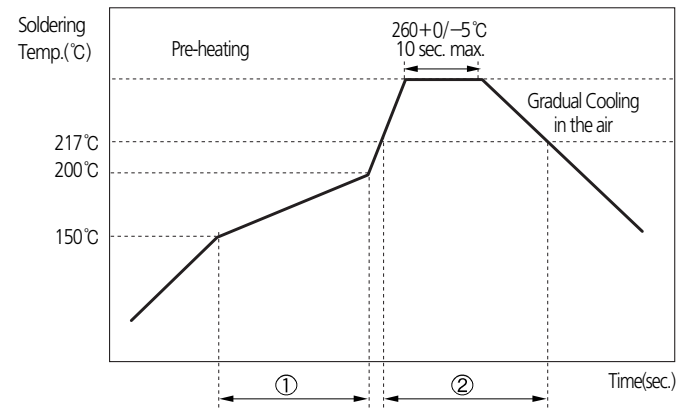

Soldering Temp. (°C)	Pre-heating Time (①, sec.)	Soldering Time (②, sec.)
260+0/-5°C	60~120	60~150

FLOW SOLDERING

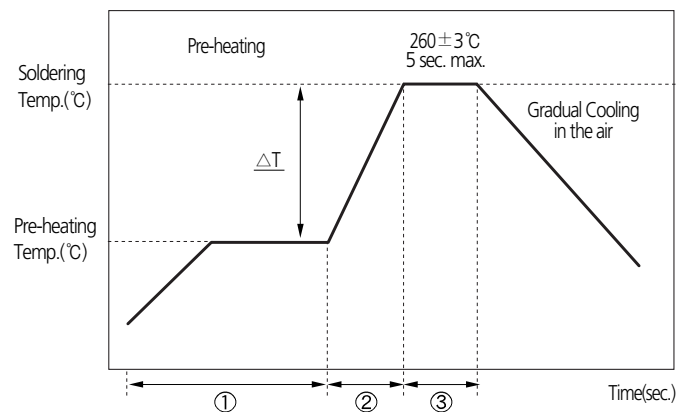

$\Delta T$ (°C)	Soldering Temp. (°C)	Pre-heating Time (①+②, sec.)	Soldering Time (③, sec.)
$\leq 150$ (1206 and below size)	260±3	$\geq 120$	$\leq 5$

SOLDER IRON(Hand Soldering)

Variation of Temp.(°C)	Soldering Temp(°C)	Pre-heating Time(sec.)	Soldering Time(sec.)	Cooling Time(sec.)	Condition of Iron Facilities		
					Wattage	Tip Diameter	Soldering Time
$\Delta T \leq 130$	300±10°C max.	$\geq 60$ sec.	$\leq 4$ sec.	-	20W max.	3mm max.	4 sec max.

※ Caution - Iron tip should not contact with ceramic body directly

6-3. Manual Soldering

Manual soldering can pose a great risk of creating thermal cracks in chip capacitors. The hot soldering iron tip comes into direct contact with the end terminations, and operator's carelessness may cause the tip of the soldering iron to come into direct contact with the ceramic body of the capacitor. Therefore the soldering iron must be handled carefully, and close attention must be paid to the selection of the soldering iron tip and to temperature control of the tip.

6-4. Amount of Solder

Too much Solder		Cracks tend to occur due to large stress.
Not enough solder		Weak holding force may cause bad connections or detaching of the capacitor

6-5. Cooling

Natural cooling using air is recommended. If the chips are dipped into solvent for cleaning, the temperature difference ( $\Delta T$ ) must be less than 100°C

6-6. Cleaning

If rosin flux is used, cleaning usually is unnecessary. When strongly activated flux is used, chlorine in the flux may dissolve into some types of cleaning fluids, thereby affecting the chip capacitors. This means that the cleaning fluid must be carefully selected, and should always be new.

7. Notes for Separating Multiple, Shared PC Boards

A multi-PC board is separated into many individual circuit boards after soldering has been completed. If the board is bent or distorted at the time of separation, cracks may occur in the chip capacitors. Carefully choose a separation method that minimizes the bending of the circuit board.

- Part Numbering System
- General Capacitors
- High Capacitance Capacitors
- Super Small Size Capacitors
- Medium-High Voltage Capacitors
- Array Type Capacitors
- Low ESL Capacitors
- Reliability Test Condition
- Premium Capacitors for Automotive Applications
- Packaging Specification
- Application Manual for Surface Mounting

**Attention**

1. This catalogue is valid only to the products purchased either from us or through our official distributors.
2. Product specifications included in this catalogue are effective as of March 1, 2013. Please be advised that they are standard product specifications for reference only. We may change, modify or discontinue the product specifications without notice at any time. So, you need to approve the product specifications before placing an order. Should you have any question regarding our product specifications, please contact our sales personnel or application engineers.
3. We may modify or cease to produce the products listed in this catalogue without notice. Should you have any question, please contact our sales personnel or application engineers.
4. Without obtaining our permission, you should not be allowed to reproduce, copy, use or transfer any content or information contained this catalogue in any manner whatsoever for any purpose.
5. In no event, will we be responsible for any claim, dispute, damage or liability whatsoever arising from, relating to or in connection with your misuse of the products or/and information included in this catalogue. We will also not assume any responsibilities whatsoever for any claim, dispute, damage or liability with regards to the intellectual property rights or other related rights of ours or any third party associated with your use of our products and/or information contained in this catalogue. We expressly disclaim that no license is granted regarding the aforementioned rights.
6. Please note that the products in this catalogue are not designed or intended to use for the applications set forth below. So, if you intend to use the products in this catalogue for the applications listed below, you should contact our sales personnel or application engineers before using. Please be aware that any misuse of the products deviating from product specifications or information provided in this catalogue may cause a serious property damage or a personal injury.

- ① Aerospace/Aviation equipment
- ② Transportation equipment (vehicles, trains, ships, etc)
- ③ Medical equipment
- ④ Military equipment
- ⑤ Disaster prevention/crime prevention equipment
- ⑥ Any other applications with the same as or similar complexity or reliability to the applications set forth above.



**Sony Green Partner**



**Quality System Certification status for each factory site**

Certification	Suwon (Korea)	Busan (Korea)	Calamba (Philippines)	Tianjin (China)	Binhai (China)
ISO / TS 16949	BSI TS 91430-000 2010-11-22 ~2013-11-21	BSI TS 91430-001 2010-08-14 ~2013-08-13	BSI TS 91430-005 2009-08-14 ~2012-08-13	BSI TS 91430-007 2011-11-29 ~2014-11-28	BSI FM 573288 2011-06-17 ~2014-06-16
ISO 14001	UL 20003847 UM 2010-07-12 ~2013-07-11	UL 20003857 UM 2010-07-11 ~2013-07-10	BSI EMS 77354 2009-08-04 ~2012-08-03	BSI EMS 585363 2012-04-17 ~2015-04-16	BSI EMS 585363 2012-04-17 ~2015-04-16
OHSAS 18001	UL 20003847 BSOH 2010-07-25 ~2013-07-24	UL 20003857 BSOH 2010-07-25 ~2013-07-24	BSI OHS 568723 2010-12-21 ~2013-12-20	BSI OHS 585364 2012-04-17 ~2015-04-16	BSI OHS 585364 2012-04-17 ~2015-04-16
Sony Green Partner	2012-06-01 ~2014-05-31	2012-06-01 ~2014-05-31	2012-06-01 ~2014-05-31	2012-06-01 ~2014-05-31	2012-06-01 ~2014-05-31
QC 080000	UL KR-HSPM-1011 2010-07-02 ~2013-07-01	UL KR-HSPM-1012 2010-07-20 ~2013-07-19	UL PI-HSPM-1001 2010-07-05 ~2013-07-04	UL PRC-HSPM-1767 2010-07-27 ~2013-07-26	