

## Complementary power transistors

### Features

- Complementary NPN-PNP devices

### Applications

- Power linear and switching

### Description

The device is manufactured in Planar technology with "Base Island" layout. The resulting transistor shows exceptional high gain performance coupled with very low saturation voltage. The PNP type is BD244C.

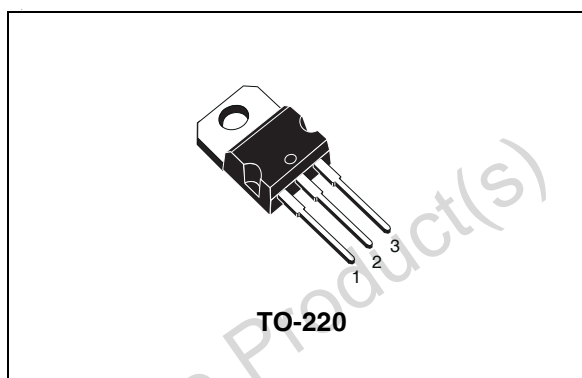

**Figure 1. Internal schematic diagram**

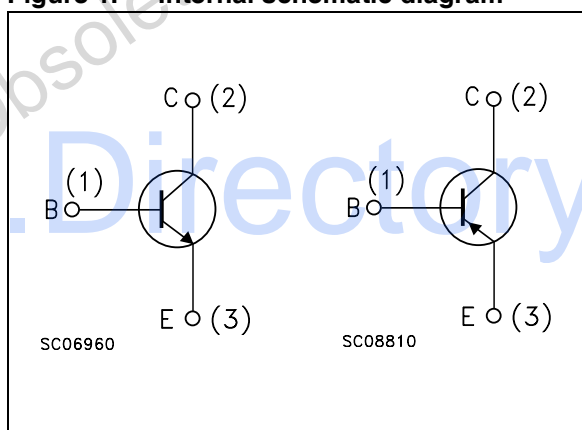

**Table 1. Device summary**

Order code	Marking	Package	Packaging
BD243C	BD243C	TO-220	Tube
BD244C	BD244C		

# 1 Absolute maximum ratings

**Table 2. Absolute maximum ratings**

Symbol	Parameter	Value		Unit
		BD243C (NPN)	BD244C (PNP)	
$V_{CBO}$	Collector-base voltage ( $I_E = 0$ )	100		V
$V_{CEO}$	Collector-emitter voltage ( $I_B = 0$ )	100		V
$V_{EBO}$	Emitte-base voltage ( $I_C = 0$ )	5		V
$I_C$	Collector current	6		A
$I_{CM}$	Collector peak current ( $t_P < 5\text{ms}$ )	10		A
$I_B$	Base current	2		A
$P_{TOT}$	Total dissipation at $T_C = 25^\circ\text{C}$	65		W
$T_{stg}$	Storage temperature	-65 to 150		$^\circ\text{C}$
$T_J$	Max. operating junction temperature	150		$^\circ\text{C}$

Note: For PNP types voltage and current values are negative

## 2 Electrical characteristics

( $T_{\text{case}} = 25^{\circ}\text{C}$ ; unless otherwise specified)

**Table 3. Electrical characteristics**

Symbol	Parameter	Test Conditions	Min.	Typ.	Max.	Unit
$I_{\text{CES}}$	Collector cut-off current ( $V_{\text{BE}} = 0$ )	$V_{\text{CE}} = 100\text{V}$			0.4	mA
$I_{\text{CEO}}$	Collector cut-off current ( $I_{\text{B}} = 0$ )	$V_{\text{CE}} = 60\text{V}$			0.7	mA
$I_{\text{EBO}}$	Emitter cut-off current ( $I_{\text{C}} = 0$ )	$V_{\text{EB}} = 5\text{V}$			1	mA
$V_{\text{CEO(sus)}}^{(1)}$	Collector-emitter sustaining voltage ( $I_{\text{B}} = 0$ )	$I_{\text{C}} = 30\text{mA}$	100			V
$V_{\text{CE(sat)}}^{(1)}$	Collector-emitter saturation voltage	$I_{\text{C}} = 6\text{A}$ $I_{\text{B}} = 1\text{A}$			1.5	V
$V_{\text{BE}}^{(1)}$	Base-emitter voltage	$I_{\text{C}} = 6\text{A}$ $I_{\text{B}} = 1\text{A}$			2	V
$h_{\text{FE}}^{(1)}$	DC current gain	$I_{\text{C}} = 0.3\text{mA}$ $V_{\text{CE}} = 4\text{V}$ $I_{\text{C}} = 3\text{A}$ $V_{\text{CE}} = 4\text{V}$	30 15			

1. Pulsed duration = 300 ms, duty cycle  $\leq 2\%$ .

Note: For PNP types voltage and current values are negative.

## 2.1 Typical characteristics

Figure 2. Safe operating area

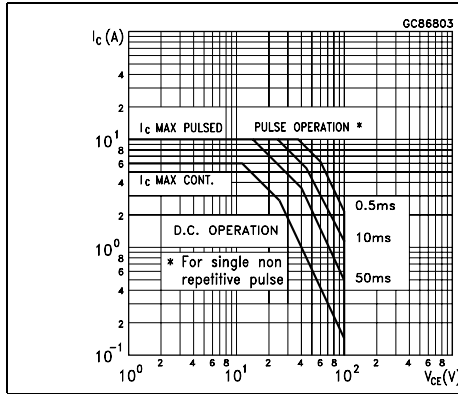

Figure 3. Derating curve

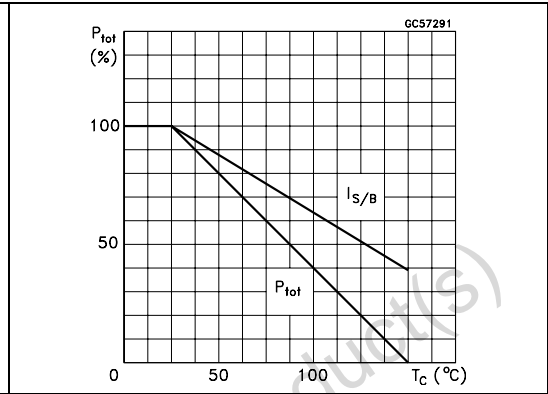

Figure 4. DC current gain (NPN)

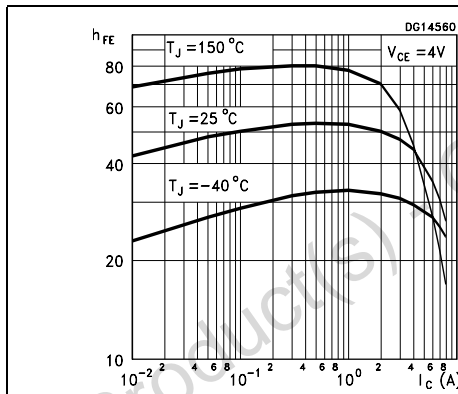

Figure 5. DC current gain (PNP)

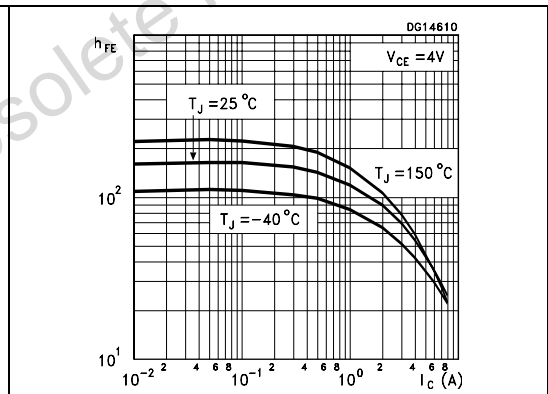

Figure 6. Collector-emitter saturation voltage (NPN)

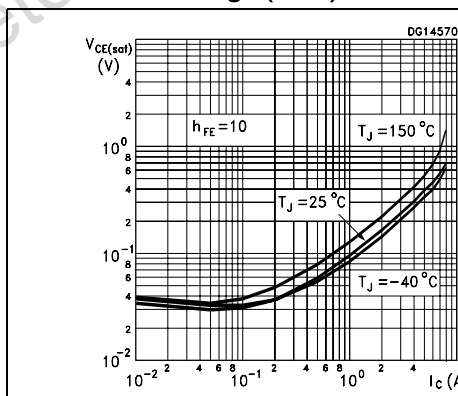

Figure 7. Collector-emitter saturation voltage (PNP)

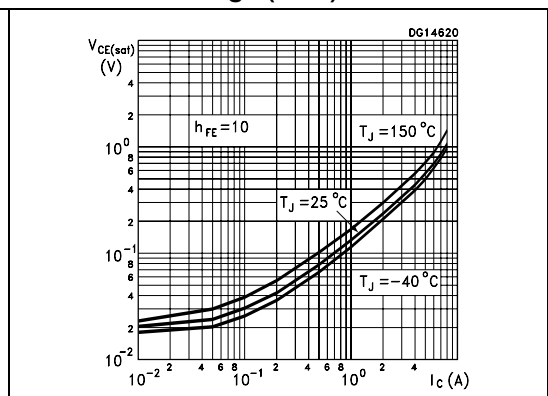

Figure 8. Base-emitter saturation voltage (NPN)

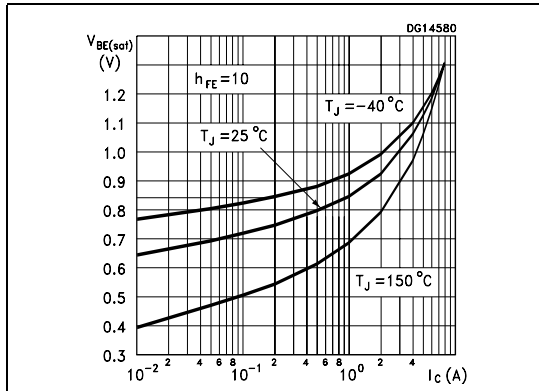

Figure 9. Base-emitter saturation voltage (PNP)

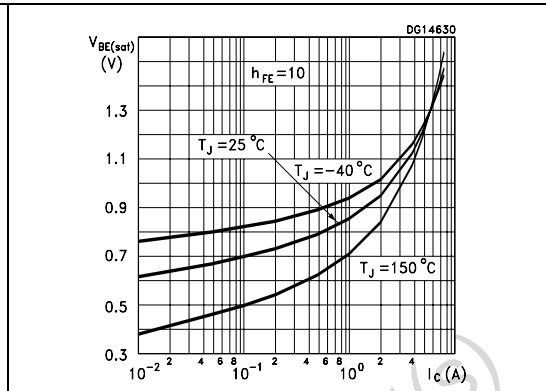

Figure 10. Base-emitter saturation voltage (NPN)

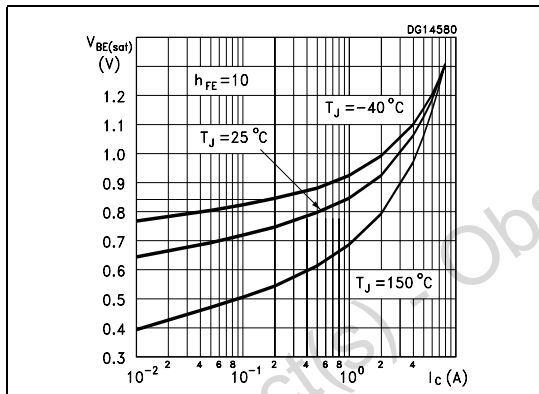

Figure 11. Base-emitter saturation voltage (PNP)

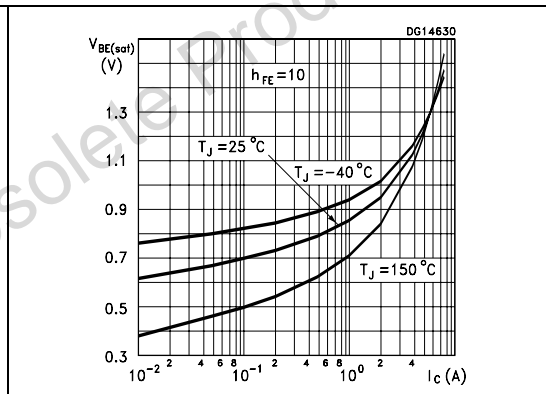

Figure 12.  $BT_{(ON)}$  time (NPN)

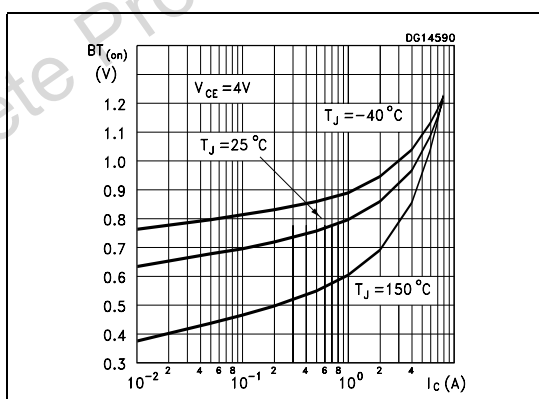

Figure 13.  $BT_{(ON)}$  time (PNP)

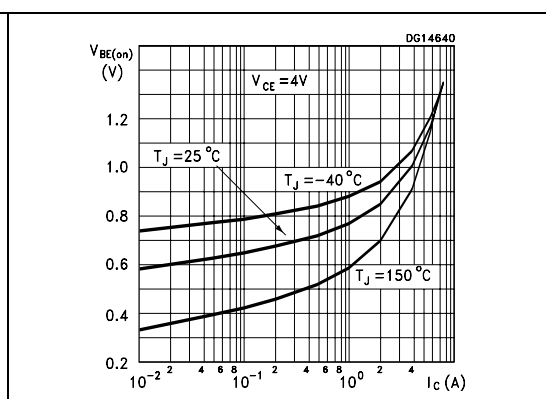

Figure 14. Resistive load switching time (NPN) Figure 15. Resistive load switching time (PNP)

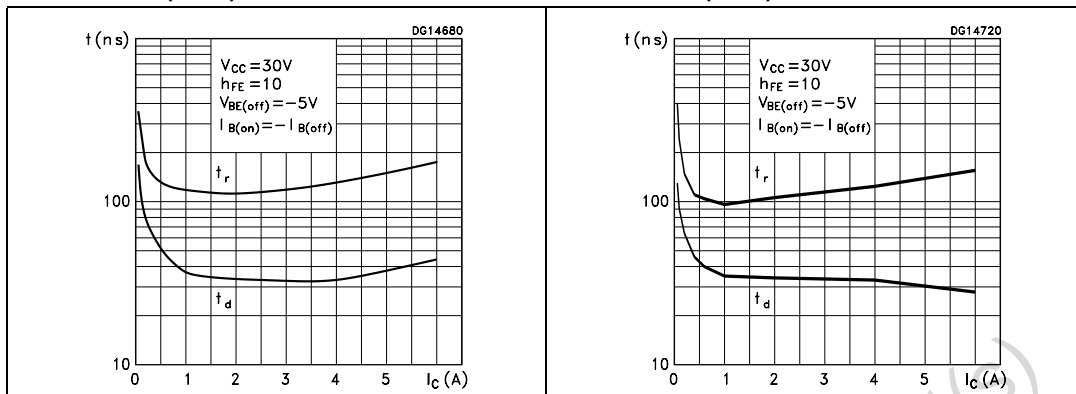

Figure 16. Resistive load switching time (NPN) Figure 17. Resistive load switching time (PNP)

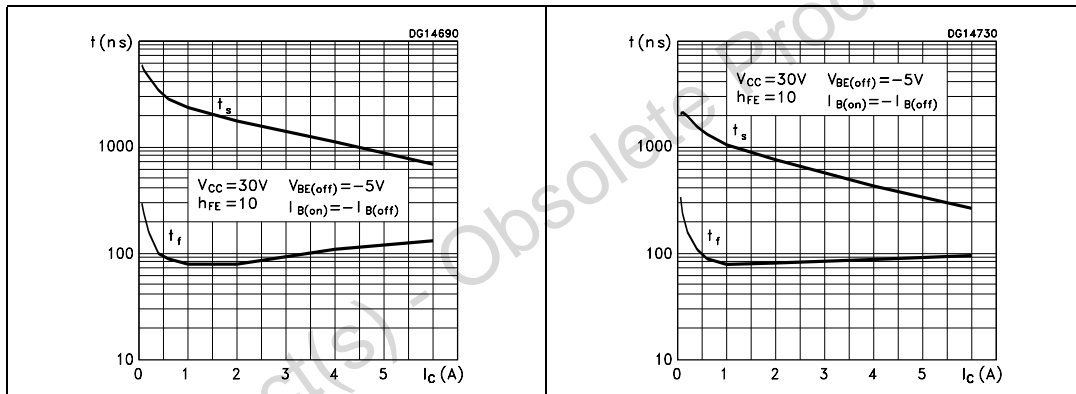
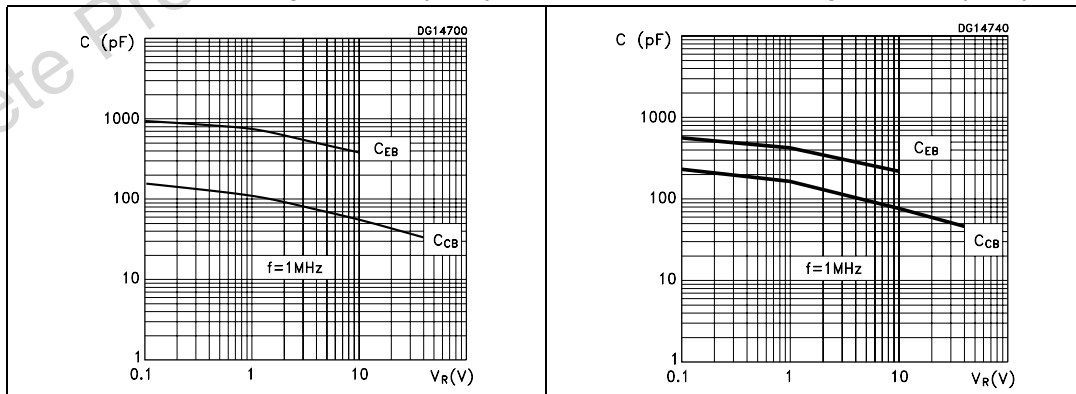

Figure 18. Collector-base and collector-emitter capacitance (NPN) Figure 19. Collector-base and collector-emitter capacitance (PNP)



### 3 Package mechanical data

In order to meet environmental requirements, ST offers these devices in ECOPACK® packages. These packages have a Lead-free second level interconnect . The category of second level interconnect is marked on the package and on the inner box label, in compliance with JEDEC Standard JESD97. The maximum ratings related to soldering conditions are also marked on the inner box label. ECOPACK is an ST trademark. ECOPACK specifications are available at: [www.st.com](http://www.st.com)

Obsolete Product(s) - Obsolete Product(s)

**TO-220 Mechanical data**

DIM.	mm.		
	MIN.	TYP	MAX.
A	4.40		4.60
b	0.61		0.88
b1	1.14		1.70
c	0.49		0.70
D	15.25		15.75
D1		1.27	
E	10		10.40
e	2.40		2.70
e1	4.95		5.15
F	1.23		1.32
H1	6.20		6.60
J1	2.40		2.72
L	13		14
L1	3.50		3.93
L20		16.40	
L30		28.90	
øP	3.75		3.85
Q	2.65		2.95

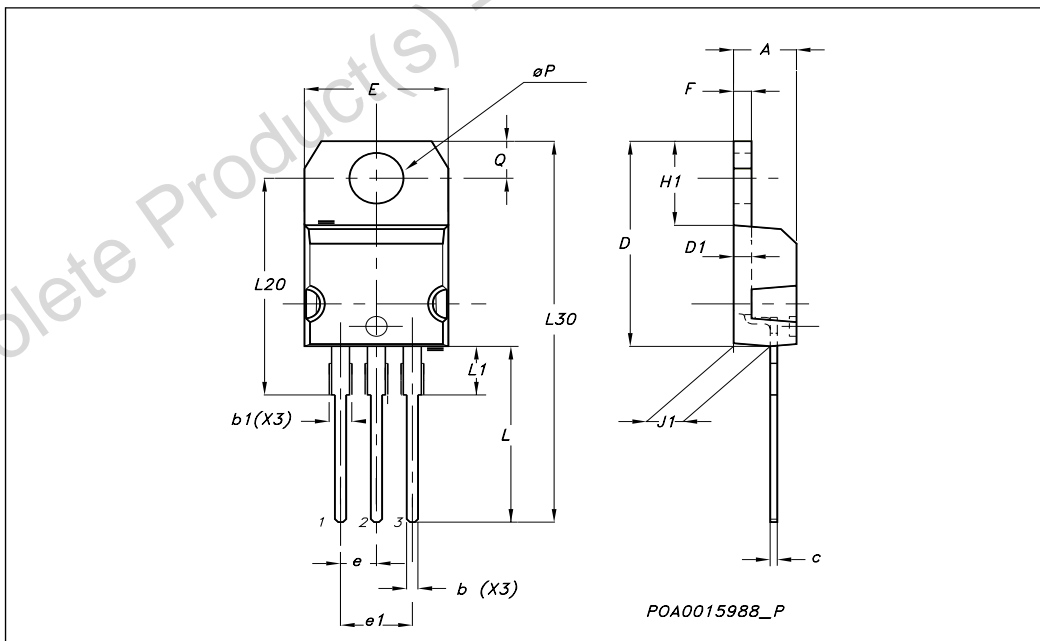



## 4 Revision history

Table 4. Revision history

Date	Revision	Changes
13-Sep-2005	4	New datasheet according to MLD-PWR/05/1267
25-Jul-2007	5	Figures 2, 3, 4, 5, 6, 7, 8, 9, 10, 11, 12, 13, 14, 15, 16, 17, 18 and figure 19, added

Obsolete Product(s) - Obsolete Product(s)

**Please Read Carefully:**

Information in this document is provided solely in connection with ST products. STMicroelectronics NV and its subsidiaries ("ST") reserve the right to make changes, corrections, modifications or improvements, to this document, and the products and services described herein at any time, without notice.

All ST products are sold pursuant to ST's terms and conditions of sale.

Purchasers are solely responsible for the choice, selection and use of the ST products and services described herein, and ST assumes no liability whatsoever relating to the choice, selection or use of the ST products and services described herein.

No license, express or implied, by estoppel or otherwise, to any intellectual property rights is granted under this document. If any part of this document refers to any third party products or services it shall not be deemed a license grant by ST for the use of such third party products or services, or any intellectual property contained therein or considered as a warranty covering the use in any manner whatsoever of such third party products or services or any intellectual property contained therein.

**UNLESS OTHERWISE SET FORTH IN ST'S TERMS AND CONDITIONS OF SALE ST DISCLAIMS ANY EXPRESS OR IMPLIED WARRANTY WITH RESPECT TO THE USE AND/OR SALE OF ST PRODUCTS INCLUDING WITHOUT LIMITATION IMPLIED WARRANTIES OF MERCHANTABILITY, FITNESS FOR A PARTICULAR PURPOSE (AND THEIR EQUIVALENTS UNDER THE LAWS OF ANY JURISDICTION), OR INFRINGEMENT OF ANY PATENT, COPYRIGHT OR OTHER INTELLECTUAL PROPERTY RIGHT.**

**UNLESS EXPRESSLY APPROVED IN WRITING BY AN AUTHORIZED ST REPRESENTATIVE, ST PRODUCTS ARE NOT RECOMMENDED, AUTHORIZED OR WARRANTED FOR USE IN MILITARY, AIR CRAFT, SPACE, LIFE SAVING, OR LIFE SUSTAINING APPLICATIONS, NOR IN PRODUCTS OR SYSTEMS WHERE FAILURE OR MALFUNCTION MAY RESULT IN PERSONAL INJURY, DEATH, OR SEVERE PROPERTY OR ENVIRONMENTAL DAMAGE. ST PRODUCTS WHICH ARE NOT SPECIFIED AS "AUTOMOTIVE GRADE" MAY ONLY BE USED IN AUTOMOTIVE APPLICATIONS AT USER'S OWN RISK.**

Resale of ST products with provisions different from the statements and/or technical features set forth in this document shall immediately void any warranty granted by ST for the ST product or service described herein and shall not create or extend in any manner whatsoever, any liability of ST.

ST and the ST logo are trademarks or registered trademarks of ST in various countries.

Information in this document supersedes and replaces all information previously supplied.

The ST logo is a registered trademark of STMicroelectronics. All other names are the property of their respective owners.

© 2007 STMicroelectronics - All rights reserved

STMicroelectronics group of companies

Australia - Belgium - Brazil - Canada - China - Czech Republic - Finland - France - Germany - Hong Kong - India - Israel - Italy - Japan - Malaysia - Malta - Morocco - Singapore - Spain - Sweden - Switzerland - United Kingdom - United States of America

[www.st.com](http://www.st.com)

# Mouser Electronics

Authorized Distributor

Click to View Pricing, Inventory, Delivery & Lifecycle Information:

[STMicroelectronics:](#)

[BD243C](#) [BD244C](#)