





1.3 W Surface Mount Glass Passivated Zener Diode

<p>DO-214AC (SMA)</p> 	<p>Voltage 6.2 to 240 V</p>	<p>Current 1.3 W</p>	
			
	<p>FEATURES</p> <ul style="list-style-type: none"> • Low profile package • Ideal for automated placement • Low leakage current • High surge current and zener capability • Low differential resistance • Tolerance series $\pm 5\%$ • Low forward voltage drop • Solder dip 260°C, 10s • AEC-Q101 qualified • Component in accordance to RoHS 2011/65/EU and WEEE 2002/96/EC • Meets MSL level 1, per J-STD-020, LF maximum peak of 260° C 		   RoHS COMPLIANT
	<p>MECHANICAL DATA</p> <ul style="list-style-type: none"> • Case: DO-214AC (SMA). Epoxy meets UL 94V-0 flammability rating. • Polarity: Color band denotes cathode end. • Terminals: Matte tin plated leads, solderable per MIL-STD-750 Method 2026, J-STD-002 and JESD22-B102. Consumer grade, meets JESD 201 class 1A whisker test. • HE3 suffix for high reliability grade, meets JESD 201 class 2 whisker test. 		
<p>TYPICAL APPLICATIONS</p> <p>Used for basic regulation functions in most electronic applications, Zener diodes offer a cheaper alternative to IC solutions.</p>			

Maximum Ratings and Electrical Characteristics at 25 °C

P_{tot}	Power dissipation at $T_{amb} = 25\text{ °C}$ $R_{th\ j-a} = 100\text{ °C/W}$	1.3 W
P_{tot}	Power dissipation at $T_{amb} = 25\text{ °C}$ $R_{th\ j-a} = 25\text{ °C/W}$	3.25 W
T_j	Operating temperature range	- 65 to + 150 °C
T_{stg}	Storage temperature range	- 65 to + 150 °C
V_F	Max. forward voltage drop at $I_F = 0.5\text{ A}$	1.0 V
$R_{th\ j-c}$	Typical Thermal Resistance	25 °C/W
$R_{th\ j-a}$	PCB epoxy-glass path 1.5 mm	150 °C/W
	PCB epoxy-glass path 5 x 10 mm	125 °C/W
	Ceramic Plate Al_2O_3) path 5 x 10 mm	100 °C/W

Other voltages upon request

1.3 W Surface Mount Glass Passivated Zener Diode

Ordering information

PREFERRED P/N	PACKAGE CODE	DELIVERY MODE	BASE QUANTITY	UNIT WEIGHT (g)
Z1SMA51 TRTB	TRTB	13" diameter tape and reel	7,500	0.060
Z1SMA51 TRTS	TRTS	7" diameter tape and reel	1,500	0.060
Z1SMA51 HE3 TRTB	TRTB	13" diameter tape and reel	7,500	0.060

Package Outline Dimensions: (mm) DO-214AC (SMA)

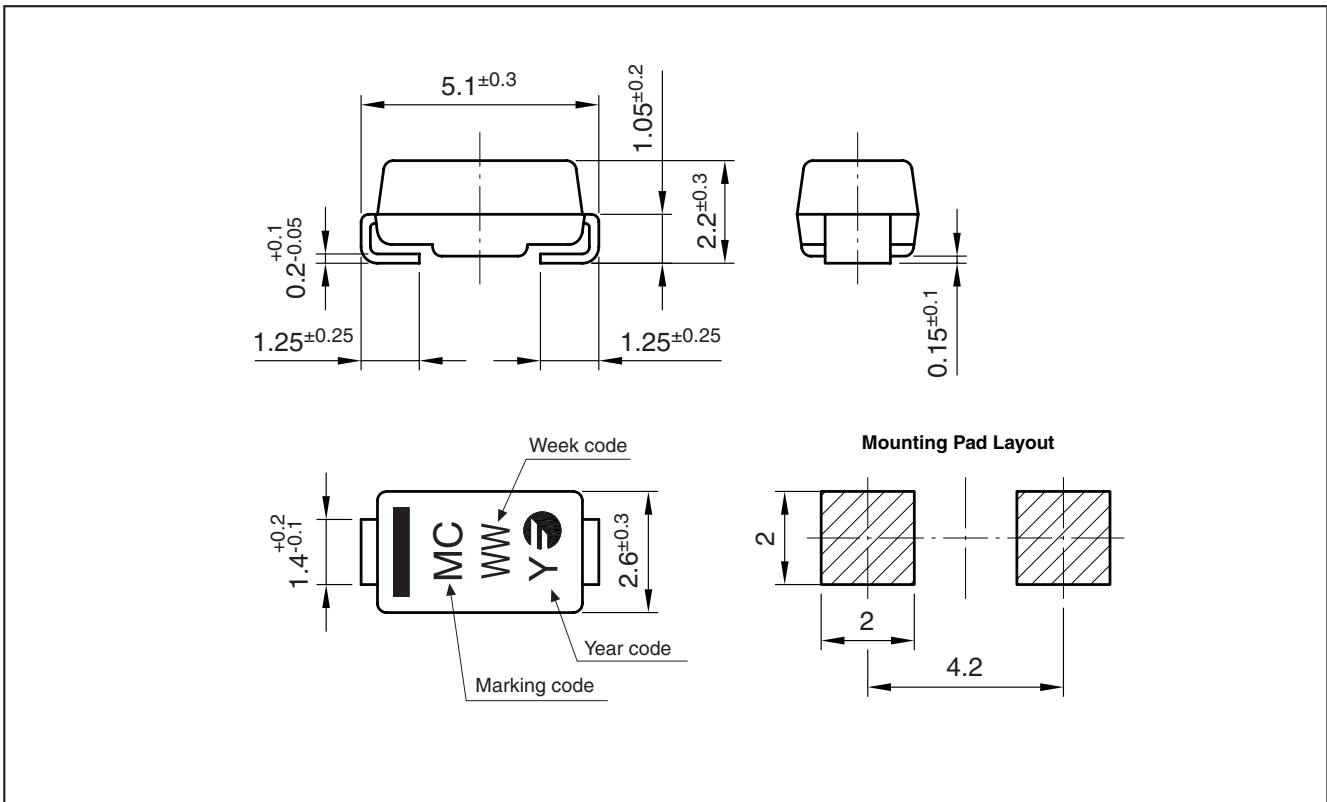

1.3 W Surface Mount Glass Passivated Zener Diode
Ratings and Characteristics (Ta 25 °C unless otherwise noted)

Type	Marking Code	Zener (1) Voltage Range V _Z at I _{ZT}	Maximum Zener Impedance Z _{ZT} at I _{ZT}	Typical Temperature Coefficient at I _{ZT}	Test Current I _{ZT}	Max Reverse Leakage Current		Max Regulator Current at 45 °C I _{ZM}
		(V)	(Ω)	(% / °C)	(mA)	I _R (μA)	@ V _R (V)	(mA)
Z1SMA6V2	EC	5.8-6.6	2	+0.025	100	10	3	161
Z1SMA6V8	EE	6.4-7.2	2.5	+0.035	100	10	4	147
Z1SMA7V5	ED	7.0-7.9	3	+0.035	100	10	5	133
Z1SMA8V2	EF	7.7-8.7	3.5	+0.055	100	10	6	122
Z1SMA9V1	EG	8.5-9.6	4	+0.055	50	10	7	110
Z1SMA10	EH	9.4-10.6	4	+0.070	50	1	7.5	105
Z1SMA11	EK	10.4-11.6	7	+0.075	50	1	8.2	97
Z1SMA12	EL	11.4-12.7	7	+0.075	50	1	9.1	88
Z1SMA13	EM	12.4-14.1	10	+0.075	50	1	10	79
Z1SMA15	EN	13.8-15.6	10	+0.075	50	1	11	71
Z1SMA16	EP	15.3-17.1	15	+0.085	25	1	12	66
Z1SMA18	EQ	16.8-19.1	15	+0.085	25	1	13	62
Z1SMA20	ER	18.8-21.2	15	+0.085	25	1	15	56
Z1SMA22	ES	20.8-23.3	15	+0.085	25	1	16	52
Z1SMA24	ET	22.8-25.6	15	+0.085	25	1	18	47
Z1SMA27	EU	25.1-28.9	15	+0.085	25	1	20	41
Z1SMA30	EV	28-32	15	+0.085	25	1	22	36
Z1SMA33	EW	31-35	15	+0.085	25	1	24	33
Z1SMA36	EX	34-38	40	+0.085	10	1	27	30
Z1SMA39	EY	37-41	40	+0.085	10	1	30	28
Z1SMA43	EZ	40-46	45	+0.095	10	1	33	26
Z1SMA47	FD	44-50	45	+0.095	10	1	36	23
Z1SMA51	FF	48-54	60	+0.095	10	1	39	21
Z1SMA56	FG	52-60	60	+0.095	10	1	43	19
Z1SMA62	FH	58-66	80	+0.105	10	1	47	16
Z1SMA68	FK	64-72	80	+0.105	10	1	51	15
Z1SMA75	FL	70-80	100	+0.105	10	1	56	14
Z1SMA82	FM	77-87	100	+0.105	10	1	62	12
Z1SMA91	FN	85-96	200	+0.110	5	1	68	10
Z1SMA100	FP	94-106	200	+0.110	5	1	75	9.4
Z1SMA110	FQ	104-116	250	+0.110	5	1	82	8.6
Z1SMA120	FR	114-127	250	+0.110	5	1	91	7.8
Z1SMA130	FS	124-141	300	+0.110	5	1	100	7.0
Z1SMA150	FT	138-156	300	+0.110	5	1	110	6.4
Z1SMA160	FU	158-171	350	+0.110	5	1	120	5.8
Z1SMA180	FV	168-191	500	+0.110	5	1	130	5.2
Z1SMA200	FW	188-212	500	+0.110	5	1	150	4.7
Z1SMA220	FE	208-233	2500	+0.110	1	1	160	4.5
Z1SMA240	FZ	228-256	2550	+0.110	1	1	180	4.2

(1) Tested with pulses.
Pulse test: t_p ≤ 50 ms; δ < 2%

1.3 W Surface Mount Glass Passivated Zener Diode

Ratings and Characteristics (Ta 25 °C unless otherwise noted)

MAXIMUM CONTINUOUS POWER DISSIPATION

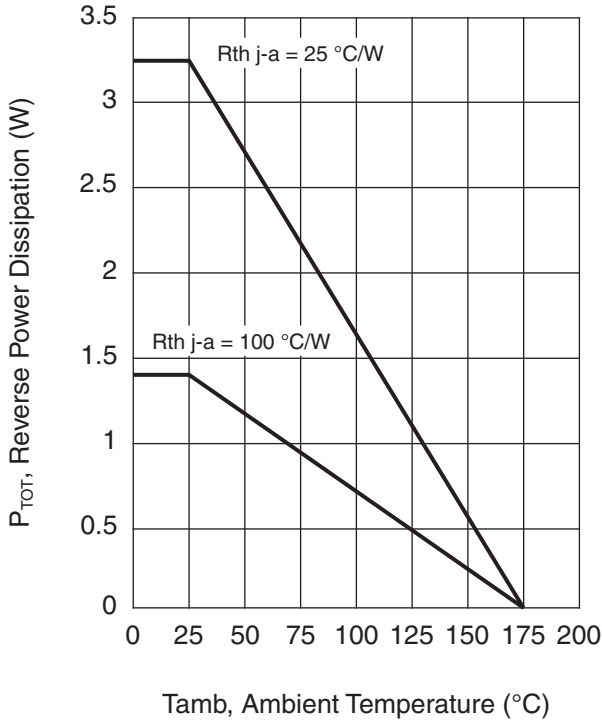

TYPICAL FORWARD CHARACTERISTIC

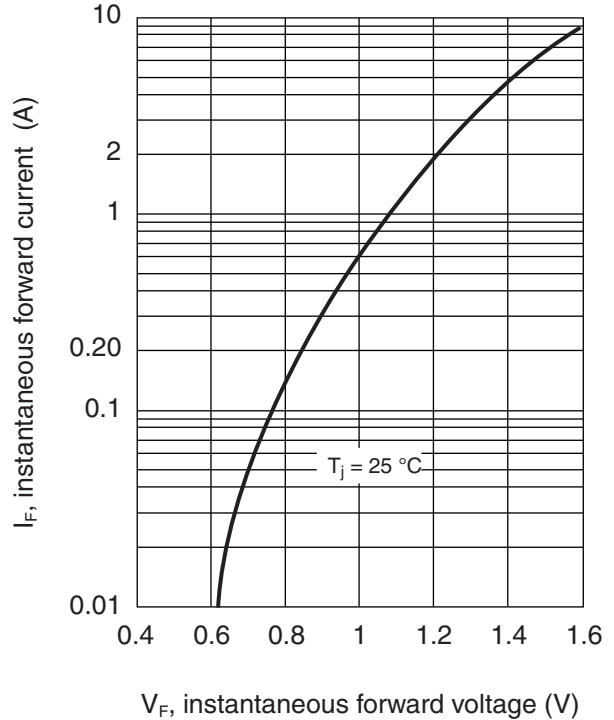

TYPICAL ZENER IMPEDANCE

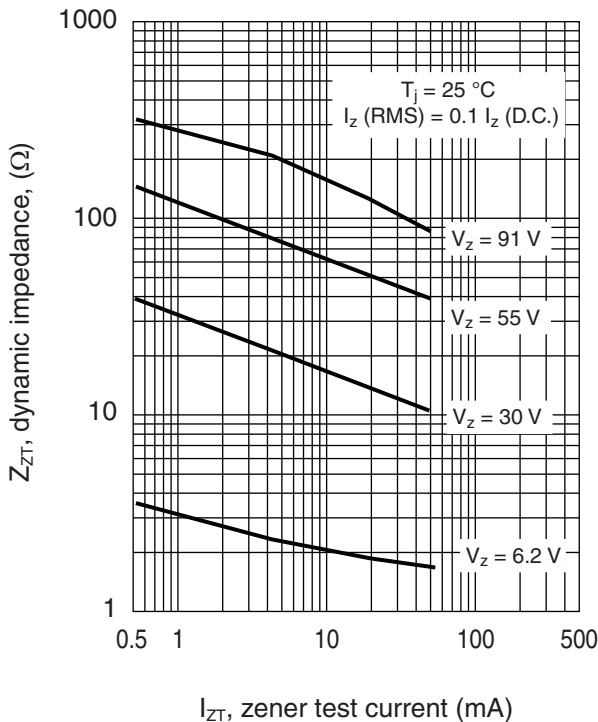

TYPICAL REVERSE CHARACTERISTIC

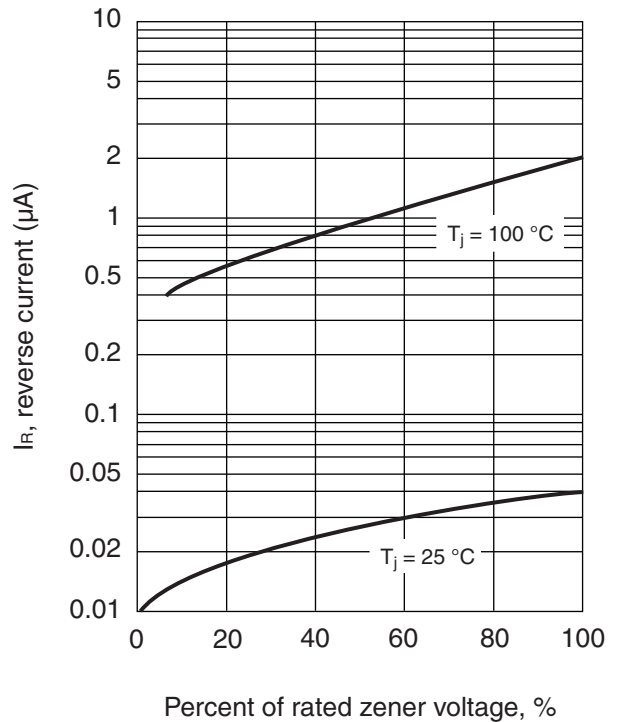

2.0 W Surface Mount Glass Passivated Zener

Disclaimer

All product, product specifications and data are subject to change without notice to improve reliability, function or design or otherwise.

Fagor Electrónica, S.Coop., its affiliates, agents, and employees, and all persons acting on its or their behalf (collectively, "Fagor"), disclaim any and all liability for any errors, inaccuracies or incompleteness contained in any datasheet or in any other disclosure relating to any product.

Fagor makes no warranty, representation or guarantee regarding the suitability of the products for any particular purpose or the continuing production of any product. To the maximum extent permitted by applicable law, Fagor disclaims (i) any and all liability arising out of the application or use of any product, (ii) any and all liability, including without limitation special, consequential or incidental damages, and (iii) any and all implied warranties, including warranties of fitness for particular purpose, non-infringement and merchantability.

Statements regarding the suitability of products for certain types of applications are based on Fagor's knowledge of typical requirements that are often placed on Fagor products in generic applications. Such statements are not binding statements about the suitability of products for a particular application. It is the customer's responsibility to validate that a particular product with the properties described in the product specification is suitable for use in a particular application. Parameters provided in datasheets and/or specifications may vary in different applications and performance may vary over time. All operating parameters, including typical parameters, must be validated for each customer application by the customer's technical experts. Product specifications do not expand or otherwise modify Fagor's terms and conditions of purchase, including but not limited to the warranty expressed therein.

Except as expressly indicated in writing, Fagor products are not designed for use in medical, life-saving, or life-sustaining applications or for any other application in which the failure of the Fagor product could result in personal injury or death. Customers using or selling Fagor products not expressly indicated for use in such applications do so at their own risk and agree to fully indemnify and hold Fagor and its distributors harmless from and against any and all claims, liabilities, expenses and damages arising or resulting in connection with such use or sale, including attorneys fees, even if such claim alleges that Fagor or its distributor was negligent regarding the design or manufacture of the part. Please contact authorized Fagor personnel to obtain written terms and conditions regarding products designed for such applications.

No license, express or implied, by estoppel or otherwise, to any intellectual property rights is granted by this document or by any conduct of Fagor, Product names and markings noted herein may be trademarks of their respective owners.