

TRANSIENT VOLTAGE SUPPRESSOR

BREAKDOWN VOLTAGE: 6.8 --- 440 V
PEAK PULSE POWER: 600 W

FEATURES

- ◇ Plastic package has underwriters laboratory flammability classification 94V-0
- ◇ Glass passivated junction
- ◇ 600W peak pulse power capability with a 10/1000µs waveform, repetition rate (duty cycle): 0.01%
- ◇ Excellent clamping capability
- ◇ Low incremental surge resistance
- ◇ Fast response time: typically less than 1.0ps from 0 Volts to $V_{(BR)}$ for uni-directional and 5.0ns for bi-directional types
- ◇ Typical I_D less than 1 µA above 10V
- ◇ High temperature soldering guaranteed: 265 °C / 10 seconds, 0.375"(9.5mm) lead length, 5lbs. (2.3kg) tension

MECHANICAL DATA

- ◇ Case: JEDEC DO-15, molded plastic body over passivated junction
- ◇ Terminals: axial leads, solderable per MIL-STD-750, method 2026
- ◇ Polarity: for uni-directional types the color band denotes the cathode, which is positive with respect to the anode under normal TVS operation
- ◇ Weight: 0.015 ounces, 0.39 grams
- ◇ Mounting position: any

DO-15

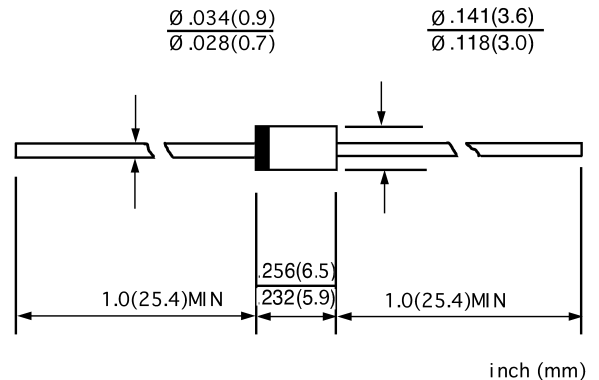

DEVICES FOR BIDIRECTIONAL APPLICATIONS

For bi-directional use C or CA suffix for types P6KE 6.8 thru types P6KE 440 (e.g. P6KE 6.8CA, P6KE 440CA).
 Electrical characteristics apply in both directions.

MAXIMUM RATINGS AND CHARACTERISTICS

Ratings at 25°C ambient temperature unless otherwise specified.

	SYMBOL	VALUE	UNIT
Peak power dissipation with a 10/1000µs waveform (NOTE 1, FIG.1)	P_{PPM}	Minimum 600	W
Peak pulse current with a 10/1000µs waveform (NOTE 1)	I_{PPM}	See table 1	A
Steady state power dissipation at $T_L=75^\circ\text{C}$ Lead lengths 0.375"(9.5mm) (NOTE 2)	$P_{M(AV)}$	5.0	W
Peak forward surge current, 8.3ms single half Sine-wave superimposed on rated load (JEDEC Method) (NOTE 3)	I_{FSM}	100.0	A
Maximum Instantaneous forward voltage at 50A for unidirectional only (NOTE 4)	V_F	3.5/5.0	V
Operating junction and storage temperature range	T_J, T_{STG}	-50---+175	°C

NOTES: (1) Non-repetitive current pulses, per Fig. 3 and derated above $T_A=25^\circ\text{C}$ per Fig. 2

(2) Mounted on copper pad area of 1.6" x 1.6"(40 x 40mm²) per Fig. 5

(3) Measured of 8.3ms single half sine-wave or square wave, duty cycle=4 pulses per minute maximum

(4) $V_F=3.5$ Volt max. for devices of $V_{(BR)} \leq 220V$, and $V_F=5.0$ Volt max. for devices of $V_{(BR)} > 220V$

www.galaxycn.com

ELECTRICAL CHARACTERISTICS (at $T_A=25$ unless otherwise noted)

TABLE 1

Type	$V_{(BR)}$		$@I_T$	V_{WM}	I_{DM}	I_{PPM}	V_C	$\alpha V_{(BR)}$
	V				$@V_{WM}$		$@I_{PPM}$	
	Min	Max	mA	V	μA	A	V	%/
P6KE6.8	6.12	7.48	10	5.50	1000	55.6	10.8	0.057
P6KE6.8A	6.45	7.14	10	5.80	1000	57.1	10.5	0.057
P6KE7.5	6.75	8.25	10	6.05	500	51.3	11.7	0.061
P6KE7.5A	7.13	7.88	10	6.40	500	53.1	11.3	0.061
P6KE8.2	7.38	9.02	10	6.63	200	48.0	12.5	0.065
P6KE8.2A	7.79	8.61	10	7.02	200	49.6	12.1	0.065
P6KE9.1	8.19	10.0	1.0	7.37	50	43.5	13.8	0.068
P6KE9.1A	8.65	9.55	1.0	7.78	50	44.8	13.4	0.068
P6KE10	9.0	11.0	1.0	8.10	10	40.0	15.0	0.073
P6KE10A	9.5	10.5	1.0	8.55	10	41.4	14.5	0.073
P6KE11	9.9	12.1	1.0	8.92	5.0	37.0	16.2	0.075
P6KE11A	10.5	11.6	1.0	9.40	5.0	38.5	15.6	0.075
P6KE12	10.8	13.2	1.0	9.72	5.0	34.7	17.3	0.078
P6KE12A	11.4	12.6	1.0	10.2	5.0	35.9	16.7	0.078
P6KE13	11.7	14.3	1.0	10.5	5.0	31.6	19.0	0.081
P6KE13A	12.4	13.7	1.0	11.1	5.0	33.0	18.2	0.081
P6KE15	13.5	16.5	1.0	12.1	5.0	27.3	22.0	0.084
P6KE15A	14.3	15.8	1.0	12.8	5.0	28.3	21.2	0.084
P6KE16	14.4	17.6	1.0	12.9	5.0	25.5	23.6	0.086
P6KE16A	15.2	16.8	1.0	13.6	5.0	26.7	22.5	0.086
P6KE18	16.2	19.8	1.0	14.5	5.0	22.6	26.5	0.088
P6KE18A	17.1	18.9	1.0	15.3	5.0	23.8	25.2	0.088
P6KE20	18.0	22.0	1.0	16.2	5.0	20.6	29.1	0.090
P6KE20A	19.0	21.0	1.0	17.1	5.0	21.7	27.7	0.090
P6KE22	19.8	24.2	1.0	17.8	5.0	18.8	31.9	0.092
P6KE22A	20.9	23.1	1.0	18.8	5.0	19.6	30.6	0.092
P6KE24	21.6	26.4	1.0	19.4	5.0	17.3	34.7	0.094
P6KE24A	22.8	25.2	1.0	20.5	5.0	18.1	33.2	0.094
P6KE27	24.3	29.7	1.0	21.8	5.0	15.3	39.1	0.096
P6KE27A	25.7	28.4	1.0	23.1	5.0	16.0	37.5	0.096
P6KE30	27.0	33.0	1.0	24.3	5.0	13.8	43.5	0.097
P6KE30A	28.5	31.5	1.0	25.6	5.0	14.5	41.4	0.097
P6KE33	29.7	36.3	1.0	26.8	5.0	12.6	47.7	0.098
P6KE33A	31.4	34.7	1.0	28.2	5.0	13.1	45.7	0.098
P6KE36	32.4	39.6	1.0	29.1	5.0	11.5	52.0	0.099
P6KE36A	34.2	37.8	1.0	30.8	5.0	12.0	49.9	0.099
P6KE39	35.1	42.9	1.0	31.6	5.0	10.6	56.4	0.100
P6KE39A	37.1	41.0	1.0	33.3	5.0	11.1	53.9	0.100
P6KE43	38.7	47.3	1.0	34.8	5.0	9.7	61.9	0.101
P6KE43A	40.9	45.2	1.0	36.8	5.0	10.1	59.3	0.101
P6KE47	42.3	51.7	1.0	38.1	5.0	8.8	67.8	0.101
P6KE47A	44.7	49.4	1.0	40.2	5.0	9.3	64.8	0.101
P6KE51	45.9	56.1	1.0	41.3	5.0	8.2	73.5	0.102
P6KE51A	48.5	53.6	1.0	43.6	5.0	8.6	70.1	0.102
P6KE56	50.4	61.6	1.0	45.4	5.0	7.5	80.5	0.103
P6KE56A	53.2	58.8	1.0	47.8	5.0	7.8	77.0	0.103

www.galaxycn.com

ELECTRICAL CHARACTERISTICS (at $T_A=25$ unless otherwise noted)

TABLE1(Cont'd)

Type	$V_{(BR)}$ (Note 1)		V_{WM}	I_{DM} (Note 3)	I_{PPM} (Note 2)	V_C	$\alpha V_{(BR)}$	
	V			@ V_{WM}		@ I_{PPM}		
	Min	Max	@ I_T mA	V	μA	A		V
P6KE62	55.8	68.2	1.0	50.2	5.0	6.7	89.0	0.104
P6KE62A	58.9	65.1	1.0	53.0	5.0	7.1	85.0	0.104
P6KE68	61.2	74.8	1.0	55.1	5.0	6.1	98.0	0.104
P6KE68A	64.6	71.4	1.0	58.1	5.0	6.5	92.0	0.104
P6KE75	67.5	82.5	1.0	60.7	5.0	5.6	108	0.105
P6KE75A	71.3	78.8	1.0	64.1	5.0	5.8	103	0.105
P6KE82	73.8	90.2	1.0	66.4	5.0	5.1	118	0.105
P6KE82A	77.9	86.1	1.0	70.1	5.0	5.3	113	0.105
P6KE91	81.9	100	1.0	73.7	5.0	4.6	131	0.106
P6KE91A	86.5	95.5	1.0	77.8	5.0	4.8	125	0.106
P6KE100	90.0	110	1.0	81.0	5.0	4.2	144	0.106
P6KE100A	95.0	105	1.0	85.5	5.0	4.4	137	0.106
P6KE110	99.0	121	1.0	89.2	5.0	3.8	158	0.107
P6KE110A	105	116	1.0	94.0	5.0	3.9	152	0.107
P6KE120	108	132	1.0	97.2	5.0	3.5	173	0.107
P6KE120A	114	126	1.0	102	5.0	3.6	165	0.107
P6KE130	117	143	1.0	105	5.0	3.2	187	0.107
P6KE130A	124	137	1.0	111	5.0	3.6	179	0.107
P6KE150	135	165	1.0	121	5.0	2.8	215	0.108
P6KE150A	143	158	1.0	128	5.0	2.9	207	0.108
P6KE160	144	176	1.0	130	5.0	2.6	230	0.108
P6KE160A	152	168	1.0	136	5.0	2.7	219	0.108
P6KE170	153	187	1.0	138	5.0	2.5	244	0.108
P6KE170A	162	179	1.0	145	5.0	2.6	234	0.108
P6KE180	162	198	1.0	146	5.0	2.3	258	0.108
P6KE180A	171	189	1.0	154	5.0	2.4	246	0.108
P6KE200	180	220	1.0	162	5.0	2.1	287	0.108
P6KE200A	190	210	1.0	171	5.0	2.2	274	0.108
P6KE220	198	242	1.0	175	5.0	1.7	344	0.108
P6KE220A	209	231	1.0	185	5.0	1.8	328	0.108
P6KE250	225	275	1.0	202	5.0	1.7	360	0.110
P6KE250A	237	263	1.0	214	5.0	1.7	344	0.110
P6KE300	270	330	1.0	243	5.0	1.4	430	0.110
P6KE300A	285	315	1.0	256	5.0	1.4	414	0.110
P6KE350	315	385	1.0	284	5.0	1.2	504	0.110
P6KE350A	332	368	1.0	300	5.0	1.2	482	0.110
P6KE400	360	440	1.0	324	5.0	1.0	574	0.110
P6KE400A	380	420	1.0	342	5.0	1.1	548	0.110
P6KE440	396	484	1.0	356	5.0	0.95	631	0.110
P6KE440A	418	462	1.0	376	5.0	1.0	602	0.110

 Notes:(1) $V_{(BR)}$ measured after I_T applied for 300 μs , I_T =square wave pulse or equivalent

www.galaxycn.com

(2) Surge current waveform per Fig. 3 and derated Fig. 2

 (3) For bidirectional types having V_{WM} of 10 volts and less, the I_D limit is doubled

FIG.1 – PEAK PULSE POWER RATING CURVE

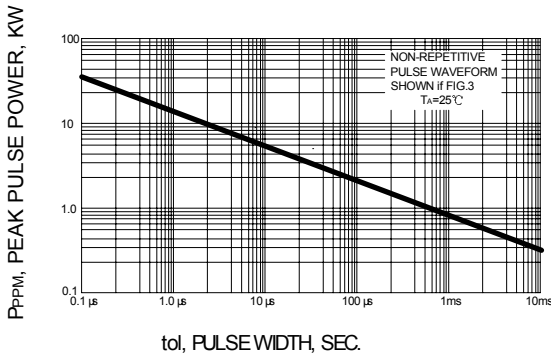

FIG.3 – PULSE WAVEFORM

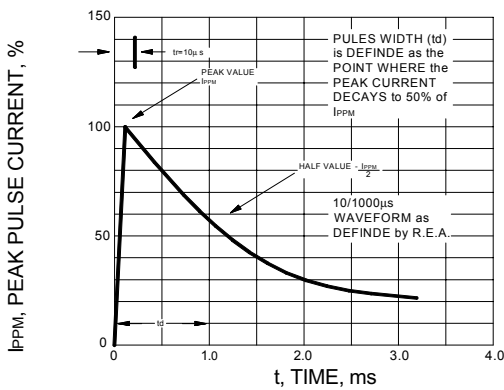

FIG.5 – STEADY STATE POWER DERATING CURVE

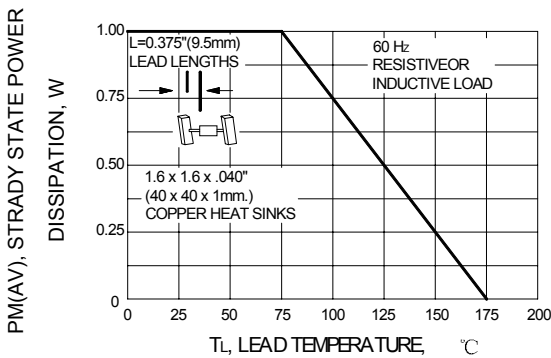

FIG.7 – TYPICAL REVERSE LEAKAGE CHARACTERISTICS

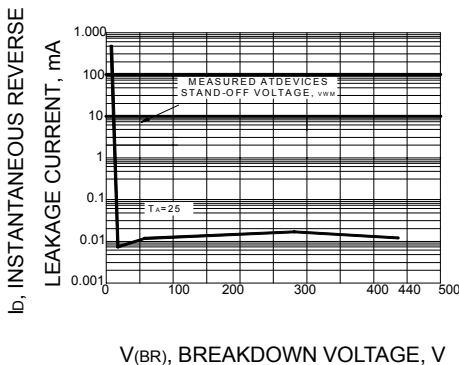

FIG.2 – PULSE DERATING CURVE

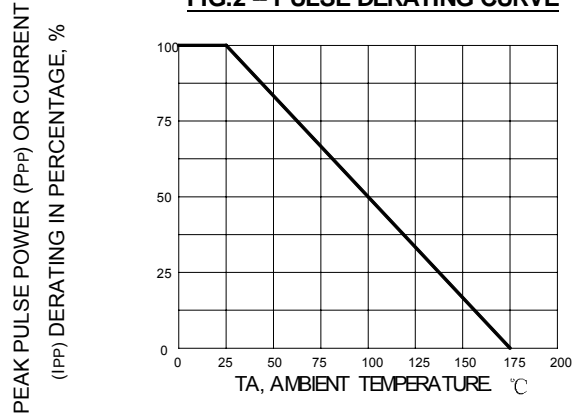

FIG.4 – TYPICAL JUNCTION CAPACITANCE UNIDIRECTIONAL

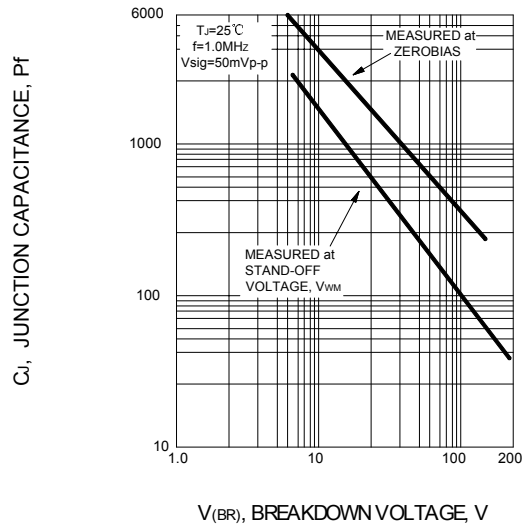

FIG.6 – MAXIMUM NON-REPETITIVE FORWARD SURGE CURRENT UNIDIRECTIONAL ONLY

