

SN54AHC540, SN74AHC540 OCTAL BUFFERS/DRIVERS WITH 3-STATE OUTPUTS

SCLS260J – DECEMBER 1995 – REVISED JULY 2003

- Operating Range 2-V to 5.5-V V_{CC}
- Latch-Up Performance Exceeds 250 mA Per JESD 17

description/ordering information

The 'AHC540 octal buffers/drivers are ideal for driving bus lines or buffer memory address registers. These devices feature inputs and outputs on opposite sides of the package to facilitate printed circuit board layout.

The 3-state control gate is a two-input AND gate with active-low inputs so that, if either output-enable ($\overline{OE1}$ or $\overline{OE2}$) input is high, all corresponding outputs are in the high-impedance state. The outputs provide inverted data when they are not in the high-impedance state.

To ensure the high-impedance state during power up or power down, \overline{OE} should be tied to V_{CC} through a pullup resistor; the minimum value of the resistor is determined by the current-sinking capability of the driver.

SN54AHC540 . . . J OR W PACKAGE
SN74AHC540 . . . DB, DGV, DW, N, NS, OR PW PACKAGE
(TOP VIEW)

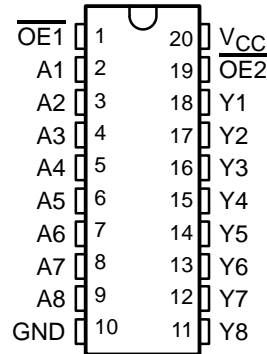

SN54AHC540 . . . FK PACKAGE
(TOP VIEW)

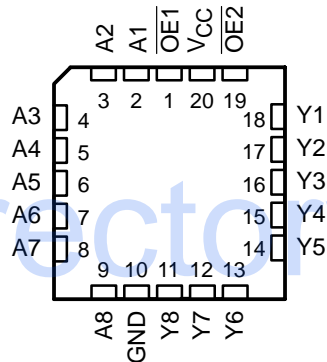

ORDERING INFORMATION

T_A	PACKAGE†		ORDERABLE PART NUMBER	TOP-SIDE MARKING
-40°C to 85°C	PDIP – N	Tube	SN74AHC540N	SN74AHC540N
	SOIC – DW	Tube	SN74AHC540DW	AHC540
		Tape and reel	SN74AHC540DWR	
	SOP – NS	Tape and reel	SN74AHC540NSR	AHC540
	SSOP – DB	Tape and reel	SN74AHC540DBR	HA540
	TSSOP – PW	Tube	SN74AHC540PW	HA540
		Tape and reel	SN74AHC540PWR	
TVSOP – DGV	Tape and reel	SN74AHC540DGV	HA540	
-55°C to 125°C	CDIP – J	Tube	SNJ54AHC540J	SNJ54AHC540J
	CFP – W	Tube	SNJ54AHC540W	SNJ54AHC540W
	LCCC – FK	Tube	SNJ54AHC540FK	SNJ54AHC540FK

† Package drawings, standard packing quantities, thermal data, symbolization, and PCB design guidelines are available at www.ti.com/sc/package.



Please be aware that an important notice concerning availability, standard warranty, and use in critical applications of Texas Instruments semiconductor products and disclaimers thereto appears at the end of this data sheet.

PRODUCTION DATA information is current as of publication date. Products conform to specifications per the terms of Texas Instruments standard warranty. Production processing does not necessarily include testing of all parameters.

 **TEXAS
INSTRUMENTS**

POST OFFICE BOX 655303 • DALLAS, TEXAS 75265

Copyright © 2003, Texas Instruments Incorporated
On products compliant to MIL-PRF-38535, all parameters are tested unless otherwise noted. On all other products, production processing does not necessarily include testing of all parameters.

**SN54AHC540, SN74AHC540
OCTAL BUFFERS/DRIVERS
WITH 3-STATE OUTPUTS**

SCLS260J – DECEMBER 1995 – REVISED JULY 2003

**FUNCTION TABLE
(each buffer/driver)**

INPUTS			OUTPUT
$\overline{OE1}$	$\overline{OE2}$	A	Y
L	L	L	H
L	L	H	L
H	X	X	Z
X	H	X	Z

logic diagram (positive logic)

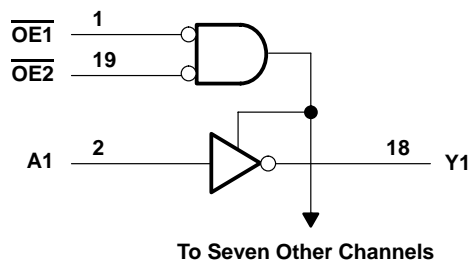

absolute maximum ratings over operating free-air temperature range (unless otherwise noted)†

Supply voltage range, V_{CC}	-0.5 V to 7 V
Input voltage range, V_I (see Note 1)	-0.5 V to 7 V
Output voltage range, V_O (see Note 1)	-0.5 V to $V_{CC} + 0.5$ V
Input clamp current, I_{IK} ($V_I < 0$)	-20 mA
Output clamp current, I_{OK} ($V_O < 0$ or $V_O > V_{CC}$)	± 20 mA
Continuous output current, I_O ($V_O = 0$ to V_{CC})	± 25 mA
Continuous current through V_{CC} or GND	± 75 mA
Package thermal impedance, θ_{JA} (see Note 2):	
DB package	70°C/W
DGV package	92°C/W
DW package	58°C/W
N package	69°C/W
NS package	60°C/W
PW package	83°C/W
Storage temperature range, T_{stg}	-65°C to 150°C

† Stresses beyond those listed under "absolute maximum ratings" may cause permanent damage to the device. These are stress ratings only, and functional operation of the device at these or any other conditions beyond those indicated under "recommended operating conditions" is not implied. Exposure to absolute-maximum-rated conditions for extended periods may affect device reliability.

- NOTES: 1. The input and output voltage ratings may be exceeded if the input and output current ratings are observed.
2. The package thermal impedance is calculated in accordance with JESD 51-7.

SN54AHC540, SN74AHC540 OCTAL BUFFERS/DRIVERS WITH 3-STATE OUTPUTS

SCLS260J – DECEMBER 1995 – REVISED JULY 2003

recommended operating conditions (see Note 3)

		SN54AHC540		SN74AHC540		UNIT
		MIN	MAX	MIN	MAX	
V _{CC}	Supply voltage	2	5.5	2	5.5	V
V _{IH}	High-level input voltage	V _{CC} = 2 V		1.5		V
		V _{CC} = 3 V		2.1		
		V _{CC} = 5.5 V		3.85		
V _{IL}	Low-level input voltage	V _{CC} = 2 V		0.5		V
		V _{CC} = 3 V		0.9		
		V _{CC} = 5.5 V		1.65		
V _I	Input voltage	0	5.5	0	5.5	V
V _O	Output voltage	0	V _{CC}	0	V _{CC}	V
I _{OH}	High-level output current	V _{CC} = 2 V		-50		μA
		V _{CC} = 3.3 V ± 0.3 V		-4		
		V _{CC} = 5 V ± 0.5 V		-8		
I _{OL}	Low-level output current	V _{CC} = 2 V		50		μA
		V _{CC} = 3.3 V ± 0.3 V		4		
		V _{CC} = 5 V ± 0.5 V		8		
Δt/Δv	Input transition rise or fall rate	V _{CC} = 3.3 V ± 0.3 V		100		ns/V
		V _{CC} = 5 V ± 0.5 V		20		
T _A	Operating free-air temperature	-55	125	-40	85	°C

NOTE 3: All unused inputs of the device must be held at V_{CC} or GND to ensure proper device operation. Refer to the TI application report, *Implications of Slow or Floating CMOS Inputs*, literature number SCBA004.

electrical characteristics over recommended operating free-air temperature range (unless otherwise noted)

PARAMETER	TEST CONDITIONS	V _{CC}	T _A = 25°C			SN54AHC540		SN74AHC540		UNIT
			MIN	TYP	MAX	MIN	MAX	MIN	MAX	
V _{OH}	I _{OH} = -50 μA	2 V	1.9	2		1.9		1.9	V	
		3 V	2.9	3		2.9		2.9		
		4.5 V	4.4	4.5		4.4		4.4		
	I _{OH} = -4 mA	3 V	2.58			2.48		2.48		
	I _{OH} = -8 mA	4.5 V	3.94			3.8		3.8		
V _{OL}	I _{OL} = 50 μA	2 V			0.1		0.1	0.1	V	
		3 V			0.1		0.1	0.1		
		4.5 V			0.1		0.1	0.1		
	I _{OL} = 4 mA	3 V			0.36		0.5	0.44		
	I _{OL} = 8 mA	4.5 V			0.36		0.5	0.44		
I _I	V _I = 5.5 V or GND	0 V to 5.5 V			±0.1		±1*	±1	μA	
I _{OZ} †	V _O = V _{CC} or GND, V _I (OE) = V _{IL} or V _{IH}	5.5 V			±0.25		±2.5	±2.5	μA	
I _{CC}	V _I = V _{CC} or GND, I _O = 0	5.5 V			4		40	40	μA	
C _i	V _I = V _{CC} or GND	5 V		2	10			10	pF	
C _o	V _O = V _{CC} or GND	5 V		4					pF	

* On products compliant to MIL-PRF-38535, this parameter is not production tested at V_{CC} = 0 V.

† For I/O pins, the parameter I_{OZ} includes the input leakage current.



SN54AHC540, SN74AHC540 OCTAL BUFFERS/DRIVERS WITH 3-STATE OUTPUTS

SCLS260J – DECEMBER 1995 – REVISED JULY 2003

switching characteristics over recommended operating free-air temperature range,
 $V_{CC} = 3.3\text{ V} \pm 0.3\text{ V}$ (unless otherwise noted) (see Figure 1)

PARAMETER	FROM (INPUT)	TO (OUTPUT)	LOAD CAPACITANCE	$T_A = 25^\circ\text{C}$			SN54AHC540		SN74AHC540		UNIT
				MIN	TYP	MAX	MIN	MAX	MIN	MAX	
t_{PLH}	A	Y	$C_L = 15\text{ pF}$	4.8*	7*	1*	8.5*	1	8.5	ns	
t_{PHL}				4.8*	7*	1*	8.5*	1	8.5		
t_{PZH}	\overline{OE}	Y	$C_L = 15\text{ pF}$	6.8*	10.5*	1*	12.5*	1	12.5	ns	
t_{PZL}				6.8*	10.5*	1*	12.5*	1	12.5		
t_{PHZ}	\overline{OE}	Y	$C_L = 15\text{ pF}$	6.8*	10.5*	1*	12.5*	1	12.5	ns	
t_{PLZ}				6.8*	10.5*	1*	12.5*	1	12.5		
t_{PLH}	A	Y	$C_L = 50\text{ pF}$	7.3	10.5	1	12	1	12	ns	
t_{PHL}				7.3	10.5	1	12	1	12		
t_{PZH}	\overline{OE}	Y	$C_L = 50\text{ pF}$	8	14	1	16	1	16	ns	
t_{PZL}				8	14	1	16	1	16		
t_{PHZ}	\overline{OE}	Y	$C_L = 50\text{ pF}$	8	15.4	1	17.5	1	17.5	ns	
t_{PLZ}				8	15.4	1	17.5	1	17.5		
$t_{sk(o)}$			$C_L = 50\text{ pF}$		1.5**				1.5	ns	

* On products compliant to MIL-PRF-38535, this parameter is not production tested.

** On products compliant to MIL-PRF-38535, this parameter does not apply.

switching characteristics over recommended operating free-air temperature range,
 $V_{CC} = 5\text{ V} \pm 0.5\text{ V}$ (unless otherwise noted) (see Figure 1)

PARAMETER	FROM (INPUT)	TO (OUTPUT)	LOAD CAPACITANCE	$T_A = 25^\circ\text{C}$			SN54AHC540		SN74AHC540		UNIT
				MIN	TYP	MAX	MIN	MAX	MIN	MAX	
t_{PLH}	A	Y	$C_L = 15\text{ pF}$	3.7*	5*	1*	6*	1	6	ns	
t_{PHL}				3.7*	5*	1*	6*	1	6		
t_{PZH}	\overline{OE}	Y	$C_L = 15\text{ pF}$	4.7*	7.2*	1*	8.5*	1	8.5	ns	
t_{PZL}				4.7*	7.2*	1*	8.5*	1	8.5		
t_{PHZ}	\overline{OE}	Y	$C_L = 15\text{ pF}$	4.5*	6.8*	1*	8*	1	8	ns	
t_{PLZ}				4.5*	6.8*	1*	8*	1	8		
t_{PLH}	A	Y	$C_L = 50\text{ pF}$	5.2	7	1	8	1	8	ns	
t_{PHL}				5.2	7	1	8	1	8		
t_{PZH}	\overline{OE}	Y	$C_L = 50\text{ pF}$	6.2	9.2	1	10.5	1	10.5	ns	
t_{PZL}				6.2	9.2	1	10.5	1	10.5		
t_{PHZ}	\overline{OE}	Y	$C_L = 50\text{ pF}$	6	8.8	1	10	1	10	ns	
t_{PLZ}				6	8.8	1	10	1	10		
$t_{sk(o)}$			$C_L = 50\text{ pF}$		1**				1	ns	

* On products compliant to MIL-PRF-38535, this parameter is not production tested.

** On products compliant to MIL-PRF-38535, this parameter does not apply.



**SN54AHC540, SN74AHC540
OCTAL BUFFERS/DRIVERS
WITH 3-STATE OUTPUTS**

SCLS260J – DECEMBER 1995 – REVISED JULY 2003

noise characteristics, $V_{CC} = 5\text{ V}$, $C_L = 50\text{ pF}$, $T_A = 25^\circ\text{C}$ (see Note 4)

PARAMETER	SN74AHC540		UNIT
	MIN	MAX	
$V_{OL(P)}$ Quiet output, maximum dynamic V_{OL}	0.8		V
$V_{OL(V)}$ Quiet output, minimum dynamic V_{OL}	-0.8		V
$V_{OH(V)}$ Quiet output, minimum dynamic V_{OH}	4.7		V
$V_{IH(D)}$ High-level dynamic input voltage	3.5		V
$V_{IL(D)}$ Low-level dynamic input voltage	1.5		V

NOTE 4: Characteristics are for surface-mount packages only.

operating characteristics, $V_{CC} = 5\text{ V}$, $T_A = 25^\circ\text{C}$

PARAMETER	TEST CONDITIONS	TYP	UNIT
C_{pd} Power dissipation capacitance	No load, $f = 1\text{ MHz}$	12	pF

SN54AHC540, SN74AHC540 OCTAL BUFFERS/DRIVERS WITH 3-STATE OUTPUTS

SCLS260J – DECEMBER 1995 – REVISED JULY 2003

PARAMETER MEASUREMENT INFORMATION

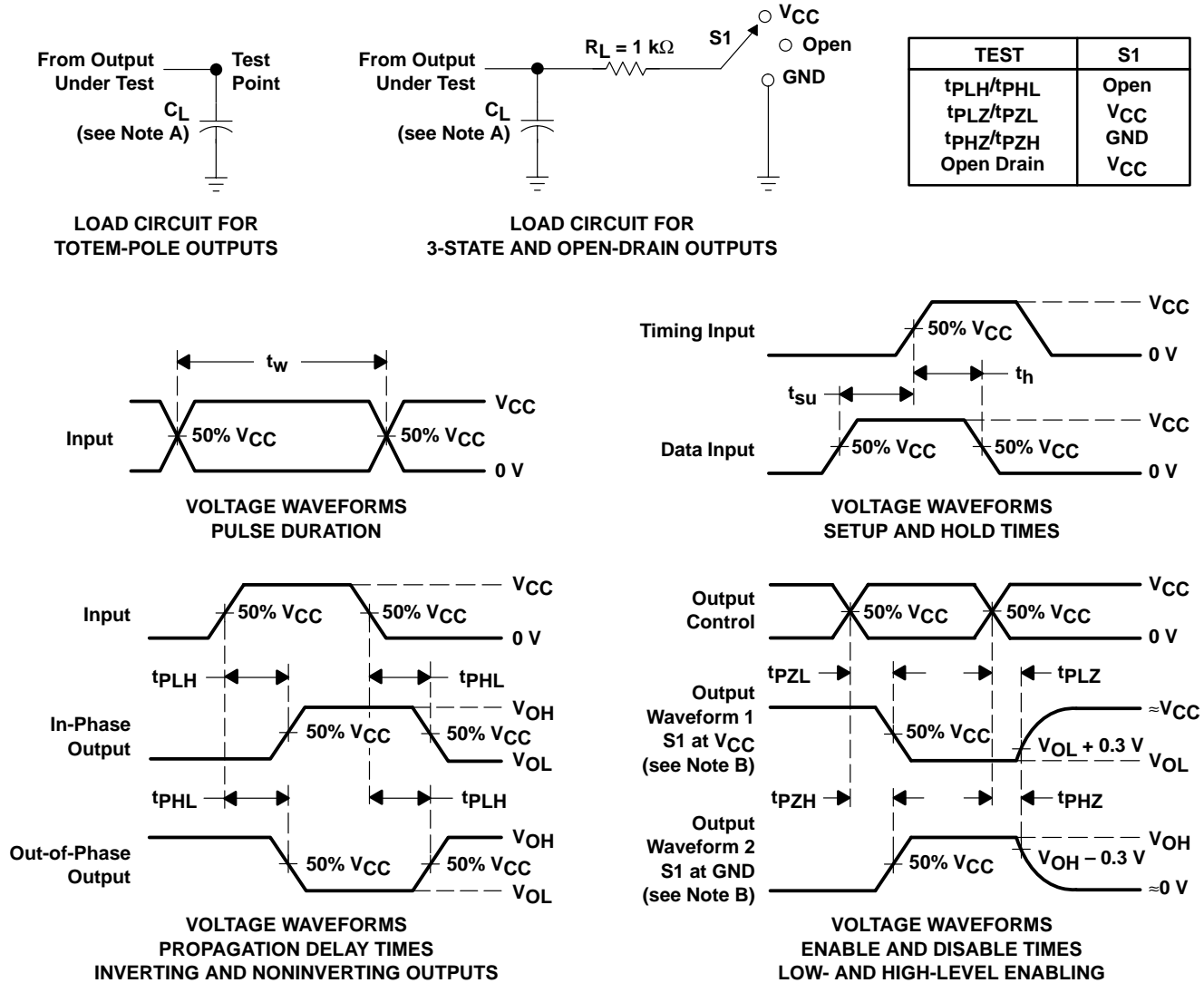

- NOTES:
- A. C_L includes probe and jig capacitance.
 - B. Waveform 1 is for an output with internal conditions such that the output is low except when disabled by the output control. Waveform 2 is for an output with internal conditions such that the output is high except when disabled by the output control.
 - C. All input pulses are supplied by generators having the following characteristics: $PRR \leq 1\text{ MHz}$, $Z_O = 50\ \Omega$, $t_r \leq 3\text{ ns}$, $t_f \leq 3\text{ ns}$.
 - D. The outputs are measured one at a time with one input transition per measurement.
 - E. All parameters and waveforms are not applicable to all devices.

Figure 1. Load Circuit and Voltage Waveforms

PACKAGING INFORMATION

Orderable Device	Status ⁽¹⁾	Package Type	Package Drawing	Pins	Package Qty	Eco Plan ⁽²⁾	Lead/ Ball Finish	MSL Peak Temp ⁽³⁾	Samples (Requires Login)
5962-9685001Q2A	ACTIVE	LCCC	FK	20	1	TBD	Call TI	Call TI	
5962-9685001QRA	ACTIVE	CDIP	J	20	1	TBD	Call TI	Call TI	
5962-9685001QSA	ACTIVE	CFP	W	20	1	TBD	Call TI	Call TI	
SN74AHC540DBLE	OBSOLETE	SSOP	DB	20		TBD	Call TI	Call TI	
SN74AHC540DBR	ACTIVE	SSOP	DB	20	2000	Green (RoHS & no Sb/Br)	CU NIPDAU	Level-1-260C-UNLIM	
SN74AHC540DBRE4	ACTIVE	SSOP	DB	20	2000	Green (RoHS & no Sb/Br)	CU NIPDAU	Level-1-260C-UNLIM	
SN74AHC540DBRG4	ACTIVE	SSOP	DB	20	2000	Green (RoHS & no Sb/Br)	CU NIPDAU	Level-1-260C-UNLIM	
SN74AHC540DGVR	ACTIVE	TVSOP	DGV	20	2000	Green (RoHS & no Sb/Br)	CU NIPDAU	Level-1-260C-UNLIM	
SN74AHC540DGVRE4	ACTIVE	TVSOP	DGV	20	2000	Green (RoHS & no Sb/Br)	CU NIPDAU	Level-1-260C-UNLIM	
SN74AHC540DGVRG4	ACTIVE	TVSOP	DGV	20	2000	Green (RoHS & no Sb/Br)	CU NIPDAU	Level-1-260C-UNLIM	
SN74AHC540DW	ACTIVE	SOIC	DW	20	25	Green (RoHS & no Sb/Br)	CU NIPDAU	Level-1-260C-UNLIM	
SN74AHC540DWE4	ACTIVE	SOIC	DW	20	25	Green (RoHS & no Sb/Br)	CU NIPDAU	Level-1-260C-UNLIM	
SN74AHC540DWG4	ACTIVE	SOIC	DW	20	25	Green (RoHS & no Sb/Br)	CU NIPDAU	Level-1-260C-UNLIM	
SN74AHC540DWR	ACTIVE	SOIC	DW	20	2000	Green (RoHS & no Sb/Br)	CU NIPDAU	Level-1-260C-UNLIM	
SN74AHC540DWRE4	ACTIVE	SOIC	DW	20	2000	Green (RoHS & no Sb/Br)	CU NIPDAU	Level-1-260C-UNLIM	
SN74AHC540DWRG4	ACTIVE	SOIC	DW	20	2000	Green (RoHS & no Sb/Br)	CU NIPDAU	Level-1-260C-UNLIM	
SN74AHC540N	ACTIVE	PDIP	N	20	20	Pb-Free (RoHS)	CU NIPDAU	N / A for Pkg Type	
SN74AHC540NE4	ACTIVE	PDIP	N	20	20	Pb-Free (RoHS)	CU NIPDAU	N / A for Pkg Type	
SN74AHC540PW	ACTIVE	TSSOP	PW	20	70	Green (RoHS & no Sb/Br)	CU NIPDAU	Level-1-260C-UNLIM	

Orderable Device	Status ⁽¹⁾	Package Type	Package Drawing	Pins	Package Qty	Eco Plan ⁽²⁾	Lead/ Ball Finish	MSL Peak Temp ⁽³⁾	Samples (Requires Login)
SN74AHC540PWE4	ACTIVE	TSSOP	PW	20	70	Green (RoHS & no Sb/Br)	CU NIPDAU	Level-1-260C-UNLIM	
SN74AHC540PWG4	ACTIVE	TSSOP	PW	20	70	Green (RoHS & no Sb/Br)	CU NIPDAU	Level-1-260C-UNLIM	
SN74AHC540PWLE	OBSOLETE	TSSOP	PW	20		TBD	Call TI	Call TI	
SN74AHC540PWR	ACTIVE	TSSOP	PW	20	2000	Green (RoHS & no Sb/Br)	CU NIPDAU	Level-1-260C-UNLIM	
SN74AHC540PWRE4	ACTIVE	TSSOP	PW	20	2000	Green (RoHS & no Sb/Br)	CU NIPDAU	Level-1-260C-UNLIM	
SN74AHC540PWRG4	ACTIVE	TSSOP	PW	20	2000	Green (RoHS & no Sb/Br)	CU NIPDAU	Level-1-260C-UNLIM	
SNJ54AHC540FK	ACTIVE	LCCC	FK	20	1	TBD	POST-PLATE	N / A for Pkg Type	
SNJ54AHC540J	ACTIVE	CDIP	J	20	1	TBD	A42	N / A for Pkg Type	
SNJ54AHC540W	ACTIVE	CFP	W	20	1	TBD	Call TI	N / A for Pkg Type	

⁽¹⁾ The marketing status values are defined as follows:

ACTIVE: Product device recommended for new designs.

LIFEBUY: TI has announced that the device will be discontinued, and a lifetime-buy period is in effect.

NRND: Not recommended for new designs. Device is in production to support existing customers, but TI does not recommend using this part in a new design.

PREVIEW: Device has been announced but is not in production. Samples may or may not be available.

OBSOLETE: TI has discontinued the production of the device.

⁽²⁾ Eco Plan - The planned eco-friendly classification: Pb-Free (RoHS), Pb-Free (RoHS Exempt), or Green (RoHS & no Sb/Br) - please check <http://www.ti.com/productcontent> for the latest availability information and additional product content details.

TBD: The Pb-Free/Green conversion plan has not been defined.

Pb-Free (RoHS): TI's terms "Lead-Free" or "Pb-Free" mean semiconductor products that are compatible with the current RoHS requirements for all 6 substances, including the requirement that lead not exceed 0.1% by weight in homogeneous materials. Where designed to be soldered at high temperatures, TI Pb-Free products are suitable for use in specified lead-free processes.

Pb-Free (RoHS Exempt): This component has a RoHS exemption for either 1) lead-based flip-chip solder bumps used between the die and package, or 2) lead-based die adhesive used between the die and leadframe. The component is otherwise considered Pb-Free (RoHS compatible) as defined above.

Green (RoHS & no Sb/Br): TI defines "Green" to mean Pb-Free (RoHS compatible), and free of Bromine (Br) and Antimony (Sb) based flame retardants (Br or Sb do not exceed 0.1% by weight in homogeneous material)

⁽³⁾ MSL, Peak Temp. -- The Moisture Sensitivity Level rating according to the JEDEC industry standard classifications, and peak solder temperature.

Important Information and Disclaimer: The information provided on this page represents TI's knowledge and belief as of the date that it is provided. TI bases its knowledge and belief on information provided by third parties, and makes no representation or warranty as to the accuracy of such information. Efforts are underway to better integrate information from third parties. TI has taken and continues to take reasonable steps to provide representative and accurate information but may not have conducted destructive testing or chemical analysis on incoming materials and chemicals. TI and TI suppliers consider certain information to be proprietary, and thus CAS numbers and other limited information may not be available for release.

In no event shall TI's liability arising out of such information exceed the total purchase price of the TI part(s) at issue in this document sold by TI to Customer on an annual basis.

OTHER QUALIFIED VERSIONS OF SN54AHC540, SN74AHC540 :

- Catalog: [SN74AHC540](#)
- Military: [SN54AHC540](#)

NOTE: Qualified Version Definitions:

- Catalog - TI's standard catalog product
- Military - QML certified for Military and Defense Applications

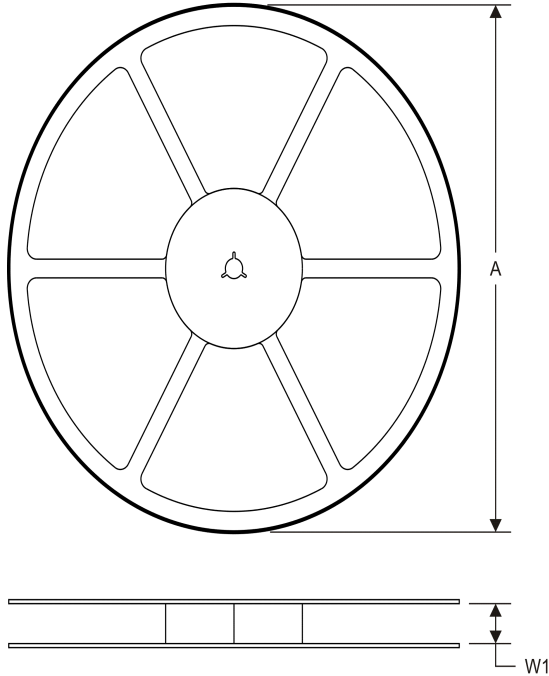
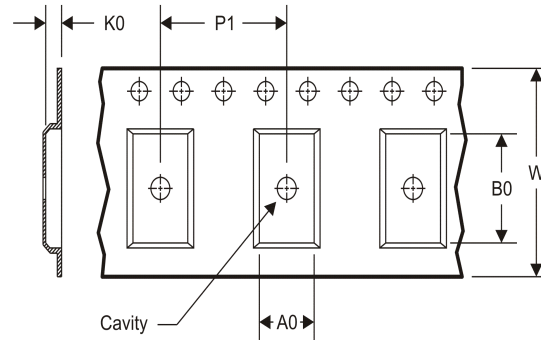
TAPE AND REEL INFORMATION
REEL DIMENSIONS

TAPE DIMENSIONS

A0	Dimension designed to accommodate the component width
B0	Dimension designed to accommodate the component length
K0	Dimension designed to accommodate the component thickness
W	Overall width of the carrier tape
P1	Pitch between successive cavity centers

TAPE AND REEL INFORMATION

*All dimensions are nominal

Device	Package Type	Package Drawing	Pins	SPQ	Reel Diameter (mm)	Reel Width W1 (mm)	A0 (mm)	B0 (mm)	K0 (mm)	P1 (mm)	W (mm)	Pin1 Quadrant
SN74AHC540DBR	SSOP	DB	20	2000	330.0	16.4	8.2	7.5	2.5	12.0	16.0	Q1
SN74AHC540DGV	TVSOP	DGV	20	2000	330.0	12.4	6.9	5.6	1.6	8.0	12.0	Q1
SN74AHC540DWR	SOIC	DW	20	2000	330.0	24.4	10.8	13.0	2.7	12.0	24.0	Q1
SN74AHC540PWR	TSSOP	PW	20	2000	330.0	16.4	6.95	7.1	1.6	8.0	16.0	Q1

TAPE AND REEL BOX DIMENSIONS

*All dimensions are nominal

Device	Package Type	Package Drawing	Pins	SPQ	Length (mm)	Width (mm)	Height (mm)
SN74AHC540DBR	SSOP	DB	20	2000	367.0	367.0	38.0
SN74AHC540DGVR	TVSOP	DGV	20	2000	367.0	367.0	35.0
SN74AHC540DWR	SOIC	DW	20	2000	367.0	367.0	45.0
SN74AHC540PWR	TSSOP	PW	20	2000	367.0	367.0	38.0

J (R-GDIP-T**)

14 LEADS SHOWN

CERAMIC DUAL IN-LINE PACKAGE



DIM \ PINS **	14	16	18	20
A	0.300 (7,62) BSC	0.300 (7,62) BSC	0.300 (7,62) BSC	0.300 (7,62) BSC
B MAX	0.785 (19,94)	.840 (21,34)	0.960 (24,38)	1.060 (26,92)
B MIN	—	—	—	—
C MAX	0.300 (7,62)	0.300 (7,62)	0.310 (7,87)	0.300 (7,62)
C MIN	0.245 (6,22)	0.245 (6,22)	0.220 (5,59)	0.245 (6,22)



4040083/F 03/03

- NOTES:
- All linear dimensions are in inches (millimeters).
 - This drawing is subject to change without notice.
 - This package is hermetically sealed with a ceramic lid using glass frit.
 - Index point is provided on cap for terminal identification only on press ceramic glass frit seal only.
 - Falls within MIL STD 1835 GDIP1-T14, GDIP1-T16, GDIP1-T18 and GDIP1-T20.

W (R-GDFP-F20)

CERAMIC DUAL FLATPACK



- NOTES:
- A. All linear dimensions are in inches (millimeters).
 - B. This drawing is subject to change without notice.
 - C. This package can be hermetically sealed with a ceramic lid using glass frit.
 - D. Index point is provided on cap for terminal identification only.
 - E. Falls within Mil-Std 1835 GDFP2-F20

FK (S-CQCC-N**)

LEADLESS CERAMIC CHIP CARRIER

28 TERMINAL SHOWN



NO. OF TERMINALS **	A		B	
	MIN	MAX	MIN	MAX
20	0.342 (8,69)	0.358 (9,09)	0.307 (7,80)	0.358 (9,09)
28	0.442 (11,23)	0.458 (11,63)	0.406 (10,31)	0.458 (11,63)
44	0.640 (16,26)	0.660 (16,76)	0.495 (12,58)	0.560 (14,22)
52	0.740 (18,78)	0.761 (19,32)	0.495 (12,58)	0.560 (14,22)
68	0.938 (23,83)	0.962 (24,43)	0.850 (21,6)	0.858 (21,8)
84	1.141 (28,99)	1.165 (29,59)	1.047 (26,6)	1.063 (27,0)



4040140/D 01/11

- NOTES:
- All linear dimensions are in inches (millimeters).
 - This drawing is subject to change without notice.
 - This package can be hermetically sealed with a metal lid.
 - Falls within JEDEC MS-004

N (R-PDIP-T**)

PLASTIC DUAL-IN-LINE PACKAGE

16 PINS SHOWN



- NOTES:
- A. All linear dimensions are in inches (millimeters).
 - B. This drawing is subject to change without notice.
 - Falls within JEDEC MS-001, except 18 and 20 pin minimum body length (Dim A).
 - The 20 pin end lead shoulder width is a vendor option, either half or full width.

DGV (R-PDSO-G**)

PLASTIC SMALL-OUTLINE

24 PINS SHOWN



4073251/E 08/00

- NOTES: A. All linear dimensions are in millimeters.
 B. This drawing is subject to change without notice.
 C. Body dimensions do not include mold flash or protrusion, not to exceed 0,15 per side.
 D. Falls within JEDEC: 24/48 Pins – MO-153
 14/16/20/56 Pins – MO-194

DW (R-PDSO-G20)

PLASTIC SMALL OUTLINE



- NOTES:
- A. All linear dimensions are in inches (millimeters). Dimensioning and tolerancing per ASME Y14.5M-1994.
 - B. This drawing is subject to change without notice.
 - C. Body dimensions do not include mold flash or protrusion not to exceed 0.006 (0,15).
 - D. Falls within JEDEC MS-013 variation AC.

DW (R-PDSO-G20)

PLASTIC SMALL OUTLINE

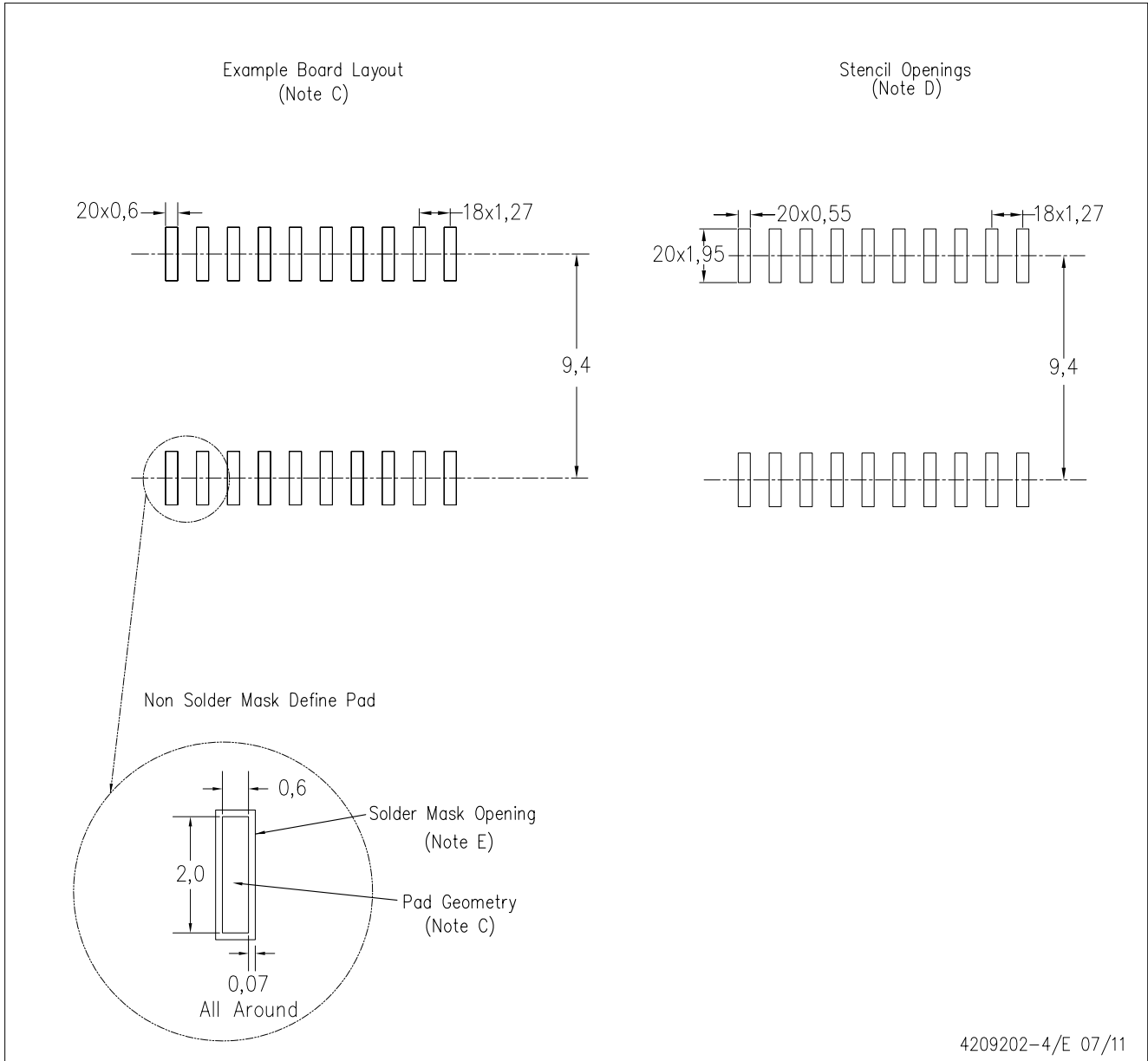

- NOTES:
- A. All linear dimensions are in millimeters.
 - B. This drawing is subject to change without notice.
 - C. Refer to IPC7351 for alternate board design.
 - D. Laser cutting apertures with trapezoidal walls and also rounding corners will offer better paste release. Customers should contact their board assembly site for stencil design recommendations. Refer to IPC-7525
 - E. Customers should contact their board fabrication site for solder mask tolerances between and around signal pads.

PW (R-PDSO-G20)

PLASTIC SMALL OUTLINE



4040064-5/G 02/11

- NOTES:
- A. All linear dimensions are in millimeters. Dimensioning and tolerancing per ASME Y14.5M-1994.
 - B. This drawing is subject to change without notice.
 - C. Body length does not include mold flash, protrusions, or gate burrs. Mold flash, protrusions, or gate burrs shall not exceed 0,15 each side.
 - D. Body width does not include interlead flash. Interlead flash shall not exceed 0,25 each side.
 - E. Falls within JEDEC MO-153

PW (R-PDSO-G20)

PLASTIC SMALL OUTLINE

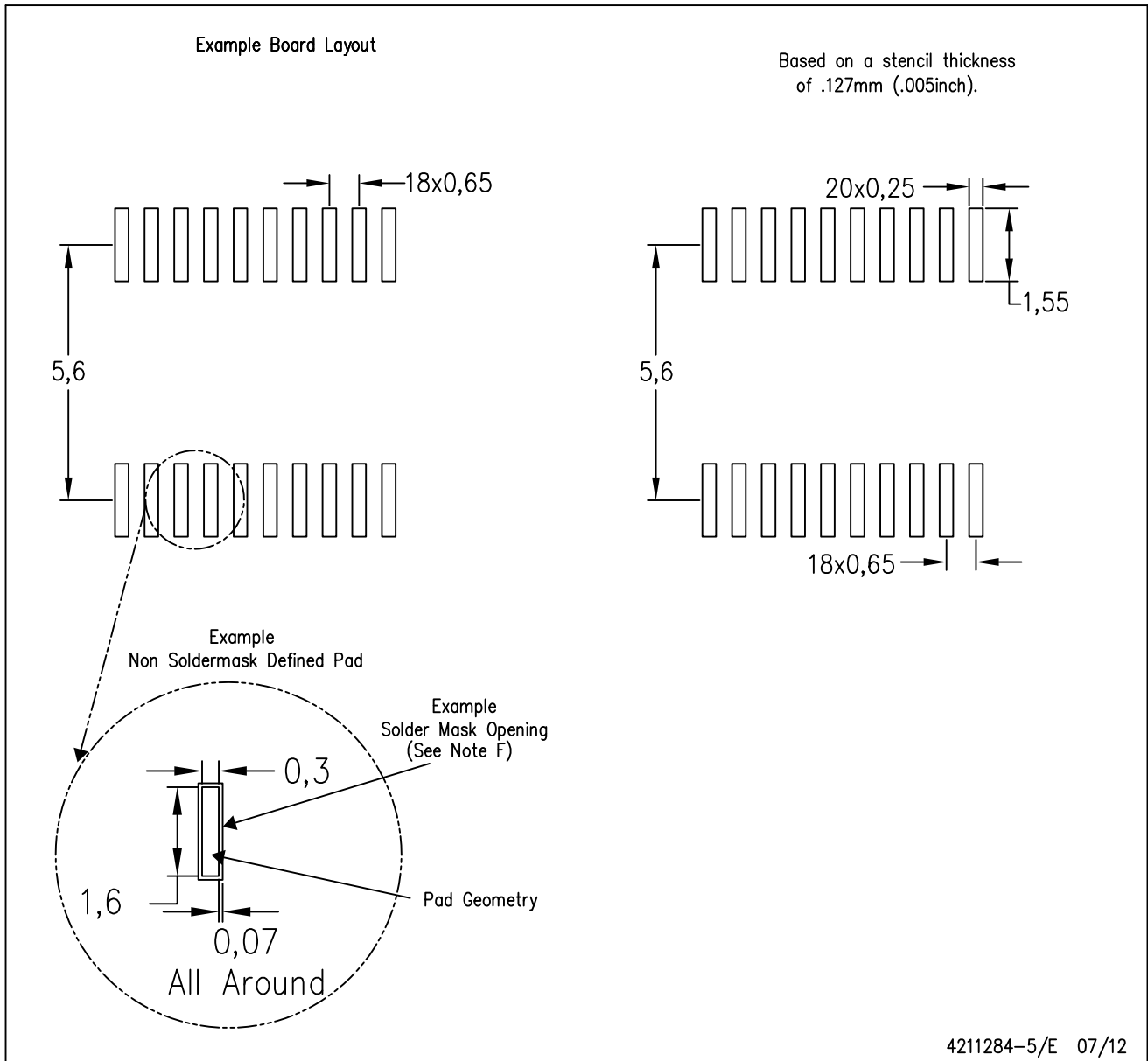

- NOTES:
- A. All linear dimensions are in millimeters.
 - B. This drawing is subject to change without notice.
 - C. Publication IPC-7351 is recommended for alternate design.
 - D. Laser cutting apertures with trapezoidal walls and also rounding corners will offer better paste release. Customers should contact their board assembly site for stencil design recommendations. Refer to IPC-7525 for other stencil recommendations.
 - E. Customers should contact their board fabrication site for solder mask tolerances between and around signal pads.

DB (R-PDSO-G**)

PLASTIC SMALL-OUTLINE

28 PINS SHOWN



- NOTES: A. All linear dimensions are in millimeters.
 B. This drawing is subject to change without notice.
 C. Body dimensions do not include mold flash or protrusion not to exceed 0,15.
 D. Falls within JEDEC MO-150

IMPORTANT NOTICE

Texas Instruments Incorporated and its subsidiaries (TI) reserve the right to make corrections, enhancements, improvements and other changes to its semiconductor products and services per JESD46C and to discontinue any product or service per JESD48B. Buyers should obtain the latest relevant information before placing orders and should verify that such information is current and complete. All semiconductor products (also referred to herein as "components") are sold subject to TI's terms and conditions of sale supplied at the time of order acknowledgment.

TI warrants performance of its components to the specifications applicable at the time of sale, in accordance with the warranty in TI's terms and conditions of sale of semiconductor products. Testing and other quality control techniques are used to the extent TI deems necessary to support this warranty. Except where mandated by applicable law, testing of all parameters of each component is not necessarily performed.

TI assumes no liability for applications assistance or the design of Buyers' products. Buyers are responsible for their products and applications using TI components. To minimize the risks associated with Buyers' products and applications, Buyers should provide adequate design and operating safeguards.

TI does not warrant or represent that any license, either express or implied, is granted under any patent right, copyright, mask work right, or other intellectual property right relating to any combination, machine, or process in which TI components or services are used. Information published by TI regarding third-party products or services does not constitute a license to use such products or services or a warranty or endorsement thereof. Use of such information may require a license from a third party under the patents or other intellectual property of the third party, or a license from TI under the patents or other intellectual property of TI.

Reproduction of significant portions of TI information in TI data books or data sheets is permissible only if reproduction is without alteration and is accompanied by all associated warranties, conditions, limitations, and notices. TI is not responsible or liable for such altered documentation. Information of third parties may be subject to additional restrictions.

Resale of TI components or services with statements different from or beyond the parameters stated by TI for that component or service voids all express and any implied warranties for the associated TI component or service and is an unfair and deceptive business practice. TI is not responsible or liable for any such statements.

Buyer acknowledges and agrees that it is solely responsible for compliance with all legal, regulatory and safety-related requirements concerning its products, and any use of TI components in its applications, notwithstanding any applications-related information or support that may be provided by TI. Buyer represents and agrees that it has all the necessary expertise to create and implement safeguards which anticipate dangerous consequences of failures, monitor failures and their consequences, lessen the likelihood of failures that might cause harm and take appropriate remedial actions. Buyer will fully indemnify TI and its representatives against any damages arising out of the use of any TI components in safety-critical applications.

In some cases, TI components may be promoted specifically to facilitate safety-related applications. With such components, TI's goal is to help enable customers to design and create their own end-product solutions that meet applicable functional safety standards and requirements. Nonetheless, such components are subject to these terms.

No TI components are authorized for use in FDA Class III (or similar life-critical medical equipment) unless authorized officers of the parties have executed a special agreement specifically governing such use.

Only those TI components which TI has specifically designated as military grade or "enhanced plastic" are designed and intended for use in military/aerospace applications or environments. Buyer acknowledges and agrees that any military or aerospace use of TI components which have **not** been so designated is solely at the Buyer's risk, and that Buyer is solely responsible for compliance with all legal and regulatory requirements in connection with such use.

TI has specifically designated certain components which meet ISO/TS16949 requirements, mainly for automotive use. Components which have not been so designated are neither designed nor intended for automotive use; and TI will not be responsible for any failure of such components to meet such requirements.

Products

Audio	www.ti.com/audio
Amplifiers	amplifier.ti.com
Data Converters	dataconverter.ti.com
DLP® Products	www.dlp.com
DSP	dsp.ti.com
Clocks and Timers	www.ti.com/clocks
Interface	interface.ti.com
Logic	logic.ti.com
Power Mgmt	power.ti.com
Microcontrollers	microcontroller.ti.com
RFID	www.ti-rfid.com
OMAP Mobile Processors	www.ti.com/omap
Wireless Connectivity	www.ti.com/wirelessconnectivity

Applications

Automotive and Transportation	www.ti.com/automotive
Communications and Telecom	www.ti.com/communications
Computers and Peripherals	www.ti.com/computers
Consumer Electronics	www.ti.com/consumer-apps
Energy and Lighting	www.ti.com/energy
Industrial	www.ti.com/industrial
Medical	www.ti.com/medical
Security	www.ti.com/security
Space, Avionics and Defense	www.ti.com/space-avionics-defense
Video and Imaging	www.ti.com/video

TI E2E Community e2e.ti.com