

N-Channel 60 V (D-S) MOSFET

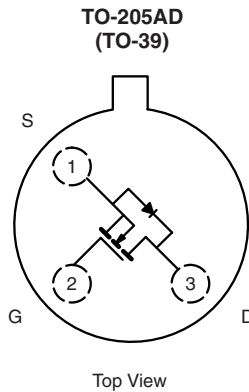

PRODUCT SUMMARY	
V_{DS} (V)	60
$R_{DS(on)}$ (Ω) at $V_{GS} = 10$ V	3
Configuration	Single



FEATURES

- Military Qualified
- Low On-Resistance: 1.3Ω
- Low Threshold: 1.7 V
- Low Input Capacitance: 35 pF
- Fast Switching Speed: 8 ns
- Low Input and Output Leakage

BENEFITS

- Guaranteed Reliability
- Low Offset Voltage
- Low-Voltage Operation
- Easily Driven Without Buffer
- High-Speed Circuits
- Low Error Voltage

APPLICATIONS

- Hi-Rel Systems
- Direct Logic-Level Interface: TTL/CMOS
- Drivers: Relays, Solenoids, Lamps, Hammers, Displays, Memories, Transistors, etc.
- Battery Operated Systems
- Solid-State Relays

ORDERING INFORMATION

PART	PACKAGE	DESCRIPTION/DSCC PART NUMBER	VISHAY ORDERING PART NUMBER
2N6660	TO-205AD (TO-39)	Commercial	2N6660
2N6660-2		Commercial, Lead (Pb)-free	2N6660-E3
2N6660JANTX		See -2 Flow Document	2N6660-2
2N6660JANTXV		JANTX2N6660 (std Au leads)	2N6660JTX02
		JANTX2N6660 (with solder)	2N6660JTXL02
		JANTX2N6660P (with PIND)	2N6660JTXP02
		JANTXV2N6660 (std Au leads)	2N6660JTXV02
JANTXV2N6660P (with PIND)		2N6660JTVP02	

ABSOLUTE MAXIMUM RATINGS ($T_A = 25^\circ\text{C}$, unless otherwise noted)

PARAMETER	SYMBOL	LIMIT	UNIT
Drain-Source Voltage	V_{DS}	60	V
Gate-Source Voltage	V_{GS}	± 20	
Continuous Drain Current ($T_J = 150^\circ\text{C}$)	I_D	$T_C = 25^\circ\text{C}$	A
		$T_C = 100^\circ\text{C}$	
Pulsed Drain Current ^a	I_{DM}	3	
Maximum Power Dissipation	P_D	$T_C = 25^\circ\text{C}$	W
		$T_A = 25^\circ\text{C}$	
Thermal Resistance, Junction-to-Ambient ^b	R_{thJA}	170	$^\circ\text{C/W}$
Thermal Resistance, Junction-to-Case	R_{thJC}	20	
Operating Junction and Storage Temperature Range	T_J, T_{stg}	- 55 to 150	$^\circ\text{C}$

Notes

- Pulse width limited by maximum junction temperature.
- Not required by military spec.



SPECIFICATIONS (T _A = 25 °C, unless otherwise noted)							
PARAMETER	SYMBOL	TEST CONDITIONS	LIMITS			UNIT	
			MIN.	TYP. ^a	MAX.		
Static							
Drain-Source Breakdown Voltage	V _{DS}	V _{DS} = 0 V, I _D = 10 μA	60	75	-	V	
Gate-Source Threshold Voltage	V _{GS(th)}	V _{DS} = V _{GS} , I _D = 1 mA	0.8	1.7	2		
			T _C = -55 °C	-	-		2.5
			T _C = 125 °C	0.3	-	-	
Gate-Body Leakage	I _{GSS}	V _{GS} = ±20 V	V _{DS} = 0 V	-	-	±100	nA
			T _C = 125 °C	-	-	±500	
Zero Gate Voltage Drain Current	I _{DSS}	V _{GS} = 0 V	V _{DS} = 48 V	-	-	1	μA
			T _C = 125 °C	-	-	100	
On-State Drain Current	I _{D(on)}	V _{GS} = 10 V	V _{DS} = 10 V	-	2	-	A
Drain-Source On-State Resistance ^b	R _{DS(on)}	V _{GS} = 5 V	I _D = 0.3 A	-	2	5	Ω
		V _{GS} = 10 V	I _D = 1 A	-	1.3	3	
				T _C = 125 °C	-	2.4	
Forward Transconductance ^b	g _{fs}	V _{DS} = 7.5 V, I _D = 0.525 A	170	350	-	mS	
Diode Forward Voltage	V _{SD}	I _S = 0.99 A, V _{GS} = 0 V	0.7	0.8	1.6	V	
Dynamic							
Input Capacitance	C _{iss}	V _{GS} = 0 V	V _{DS} = 25 V, f = 1 MHz	-	35	50	pF
Output Capacitance	C _{oss}			-	25	40	
Reverse Transfer Capacitance	C _{rss}			-	7	10	
Drain-Source Capacitance	C _{ds}			-	30	-	
Switching^c							
Turn-On Time	t _{ON}	V _{DD} = 25 V, R _L = 23 Ω I _D ≅ 1 A, V _{GEN} = 10 V, R _g = 25 Ω	-	8	10	ns	
Turn-Off Time	t _{OFF}		-	8.5	10		

Notes

- a. FOR DESIGN AID ONLY, not subject to production testing.
- b. Pulse test: PW ≤ 300 μs duty cycle ≤ 2 %.
- c. Switching time is essentially independent of operating temperature.

Stresses beyond those listed under "Absolute Maximum Ratings" may cause permanent damage to the device. These are stress ratings only, and functional operation of the device at these or any other conditions beyond those indicated in the operational sections of the specifications is not implied. Exposure to absolute maximum rating conditions for extended periods may affect device reliability.



TYPICAL CHARACTERISTICS (25 °C, unless otherwise noted)



Ohmic Region Characteristics

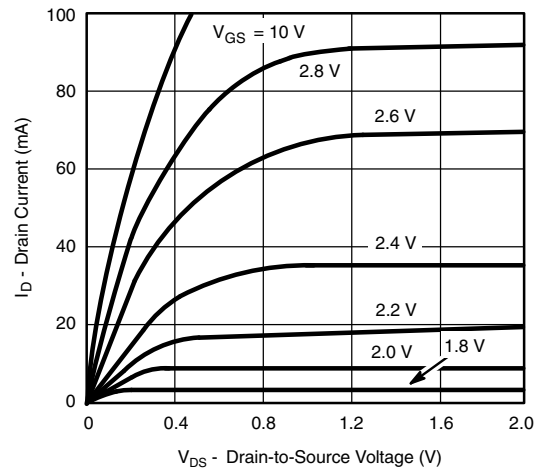

Output Characteristics for Low Gate Drive



Transfer Characteristics

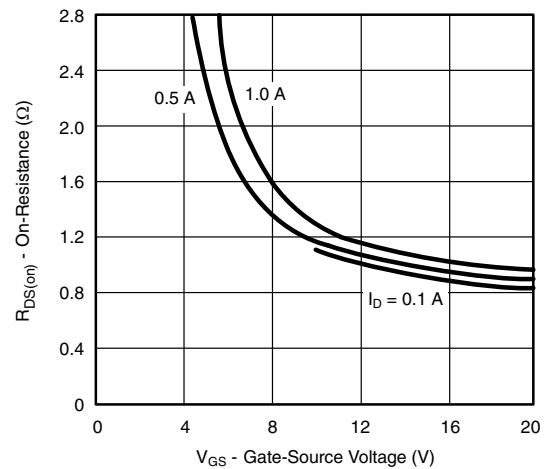

On-Resistance vs. Gate-to-Source Voltage

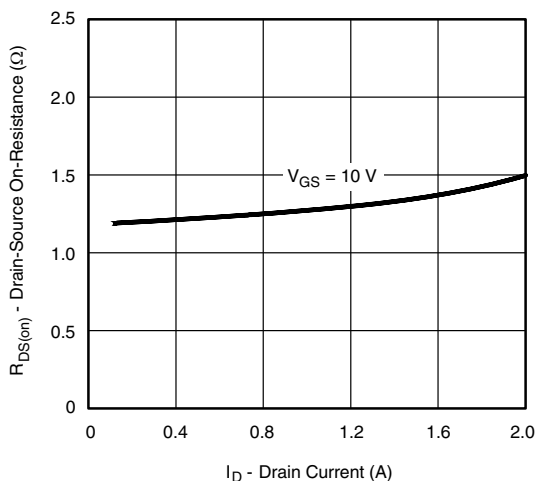

On-Resistance vs. Drain Current

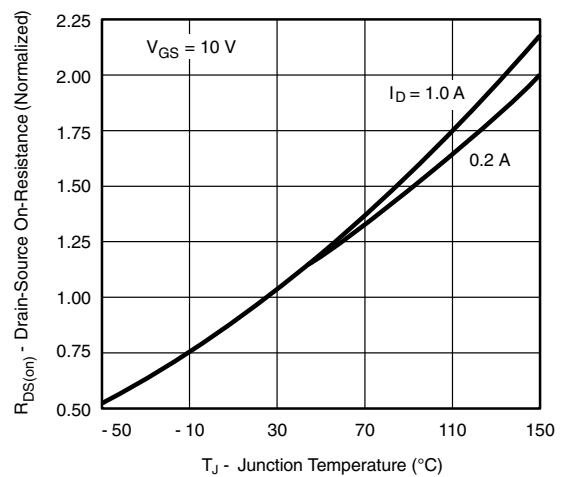

Normalized On-Resistance vs. Junction Temperature



TYPICAL CHARACTERISTICS (25 °C, unless otherwise noted)

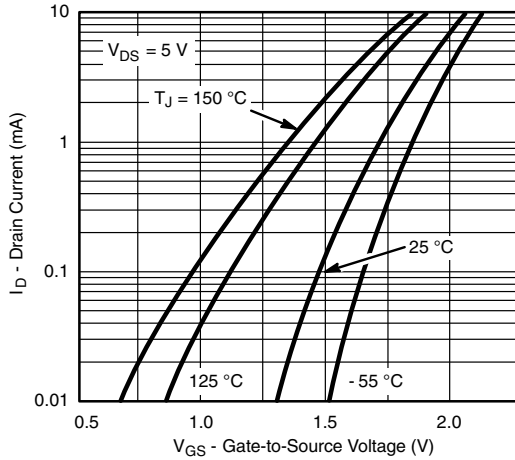

Threshold Region



Capacitance

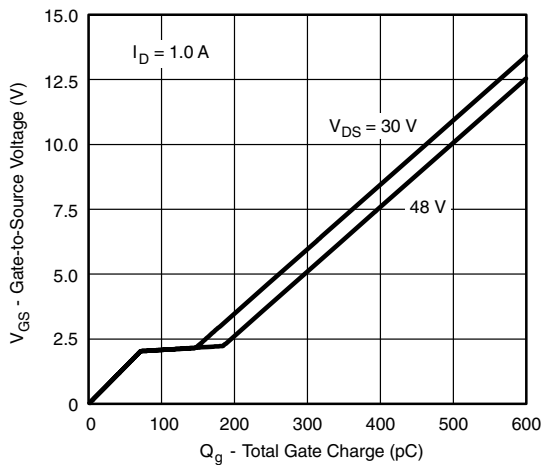

Gate Charge

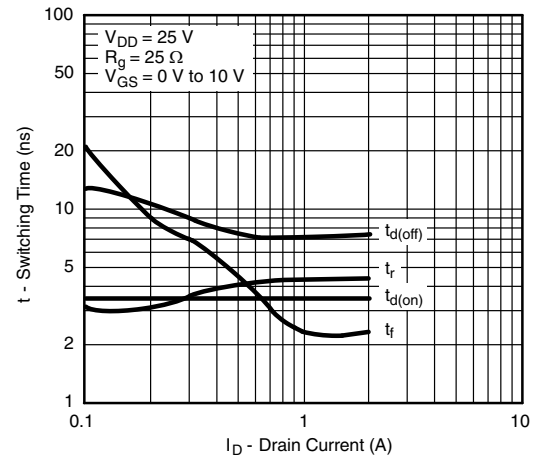

Load Condition Effects on Switching



Normalized Thermal Transient Impedance, Junction-to-Ambient

Vishay Siliconix maintains worldwide manufacturing capability. Products may be manufactured at one of several qualified locations. Reliability data for Silicon Technology and Package Reliability represent a composite of all qualified locations. For related documents such as package/tape drawings, part marking, and reliability data, see www.vishay.com/ppg?70223.

TO-205AD (TO-39 TALL LID)

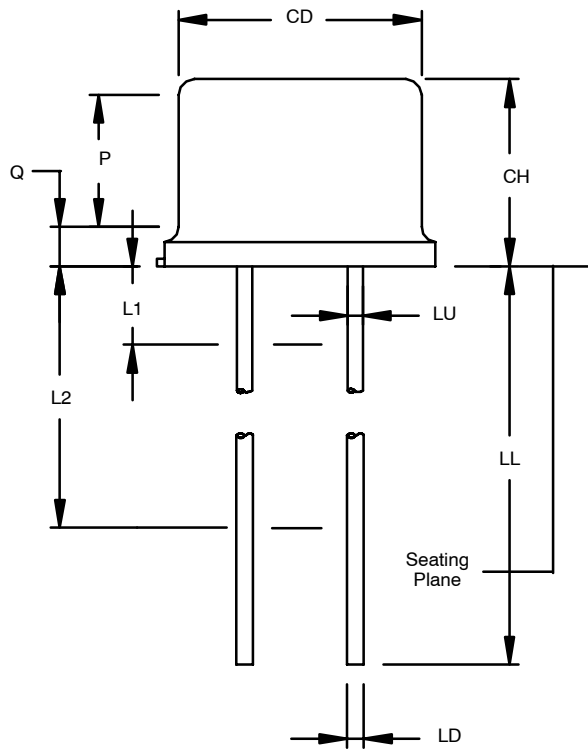

Dim	INCHES		MILLIMETERS		Notes
	Min	Max	Min	Max	
CD	0.305	0.335	7.75	8.51	
CH	0.240	0.260	6.10	6.60	
HD	0.335	0.370	8.51	9.40	
LC	0.200 TP		5.08 TP		6
LD	0.016	0.021	0.41	0.53	7, 8
LL	0.500	0.750	12.70	19.05	7, 8
LU	0.016	0.019	0.41	0.48	7, 8
L1	—	0.050	—	1.27	7, 8
L2	0.250	—	6.35	—	7, 8
P	0.100	—	2.54	—	5
Q	—	0.050	—	1.27	4
r	—	0.010	—	0.25	9
TL	0.029	0.045	0.74	1.14	3
TW	0.028	0.034	0.71	0.86	2
α	45° TP		45° TP		6

Dimensions (see notes 1, 2, 9, 11, 12)
 ECN: S-40373—Rev. C, 15-Mar-04
 DWG: 5511

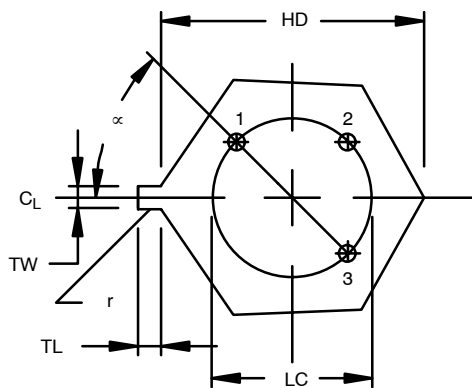

NOTES:

- Dimensions are in inches. Metric equivalents are given for general information only.
- Beyond radius (r) maximum, TW shall be held for a minimum length of 0.011 (0.028 mm).
- Dimension TL measured from maximum HD.
- Outline in this zone is not controlled.
- Dimension CD shall not vary more than 0.010 (0.25 mm) in zone P. This zone is controlled for automatic handling.
- Leads at gauge plane $0.054+0.001, -0.000$ ($1.37+0.03, -0.00$ mm) below seating plane shall be within 0.007 (0.18 mm) radius of true position (TP) at maximum material condition (MMC) relative to tab at MMC.
- LU applies between L1 and L2, LD applies between L2 and L maximum. Diameter is uncontrolled in L1 and beyond LL minimum.
- All three leads.
- Radius (r) applies to both inside corners of tab.
- Drain is electrically connected to the case.



Disclaimer

ALL PRODUCT, PRODUCT SPECIFICATIONS AND DATA ARE SUBJECT TO CHANGE WITHOUT NOTICE TO IMPROVE RELIABILITY, FUNCTION OR DESIGN OR OTHERWISE.

Vishay Intertechnology, Inc., its affiliates, agents, and employees, and all persons acting on its or their behalf (collectively, "Vishay"), disclaim any and all liability for any errors, inaccuracies or incompleteness contained in any datasheet or in any other disclosure relating to any product.

Vishay makes no warranty, representation or guarantee regarding the suitability of the products for any particular purpose or the continuing production of any product. To the maximum extent permitted by applicable law, Vishay disclaims (i) any and all liability arising out of the application or use of any product, (ii) any and all liability, including without limitation special, consequential or incidental damages, and (iii) any and all implied warranties, including warranties of fitness for particular purpose, non-infringement and merchantability.

Statements regarding the suitability of products for certain types of applications are based on Vishay's knowledge of typical requirements that are often placed on Vishay products in generic applications. Such statements are not binding statements about the suitability of products for a particular application. It is the customer's responsibility to validate that a particular product with the properties described in the product specification is suitable for use in a particular application. Parameters provided in datasheets and/or specifications may vary in different applications and performance may vary over time. All operating parameters, including typical parameters, must be validated for each customer application by the customer's technical experts. Product specifications do not expand or otherwise modify Vishay's terms and conditions of purchase, including but not limited to the warranty expressed therein.

Except as expressly indicated in writing, Vishay products are not designed for use in medical, life-saving, or life-sustaining applications or for any other application in which the failure of the Vishay product could result in personal injury or death. Customers using or selling Vishay products not expressly indicated for use in such applications do so at their own risk and agree to fully indemnify and hold Vishay and its distributors harmless from and against any and all claims, liabilities, expenses and damages arising or resulting in connection with such use or sale, including attorneys fees, even if such claim alleges that Vishay or its distributor was negligent regarding the design or manufacture of the part. Please contact authorized Vishay personnel to obtain written terms and conditions regarding products designed for such applications.

No license, express or implied, by estoppel or otherwise, to any intellectual property rights is granted by this document or by any conduct of Vishay. Product names and markings noted herein may be trademarks of their respective owners.