

## LINEAR INTEGRATED CIRCUITS

### DESCRIPTION

The LM101A and LM301A are high performance operational amplifiers featuring high gain, short circuit protection, simplified compensation and excellent temperature stability.

### FEATURES

- SHORT CIRCUIT PROTECTION
- OFFSET VOLTAGE NULL CAPABILITY
- LARGE COMMON-MODE AND DIFFERENTIAL VOLTAGE RANGES
- LOW POWER CONSUMPTION
- NO LATCH UP

### ABSOLUTE MAXIMUM RATINGS

Supply Voltage	LM101A	±22V
	LM301A	±18V
Power Dissipation (Note 1)		500mW
Differential Input Voltage		±30V
Input Voltage (Note 2)		±15V
Output Short Circuit Duration		Indefinite
Operating Temperature Range	LM101A	-55°C to 125°C
	LM301A	0°C to 70°C
Storage Temperature Range		-65°C to 150°C
Lead Temperature (Soldering, 60 sec.)		300°C

### NOTES:

1. Absolute maximum rating holds for all packages. The maximum junction temperature is 150°C for the LM101A and 100°C for the LM301A. For operation at elevated temperatures, derate according to appropriate thermal resistances given under package information.
2. For supply voltages less than ±15V, the absolute maximum input voltage is equal to the supply voltage.

### EQUIVALENT CIRCUIT

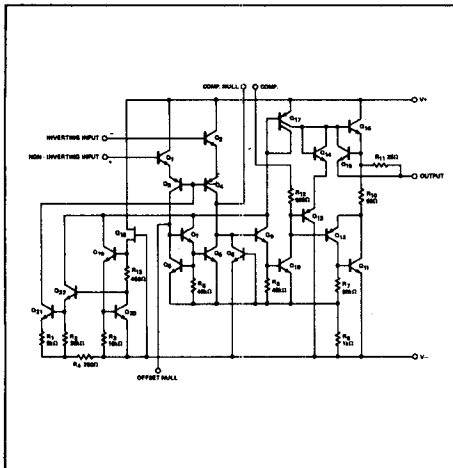

### PIN CONFIGURATIONS

#### A & F PACKAGE (Top View)

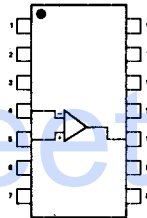

1. NC
2. NC
3. Freq. Comp./Offset Null
4. Inverting Input
5. Noninverting Input
6. V<sup>-</sup>
7. NC
8. NC
9. Offset Null
10. Output
11. V<sup>+</sup>
12. Freq. Comp.
13. NC
14. NC

#### ORDER PART NOS.

LM101AD/LM301AD LM101AN-14/LM301AN-14

#### G PACKAGE

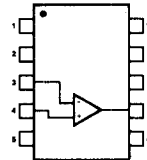

1. NC
2. Bal/Comp
3. Input
4. Input
5. V<sup>-</sup>
6. Bal
7. Output
8. V<sup>+</sup>
9. Comp
10. NC

#### ORDER PART NOS.

LM101AF/LM301AF

#### T PACKAGE

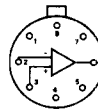

1. Freq. Comp./Offset Null
2. Inverting Input
3. Noninverting Input
4. V<sup>-</sup>
5. Offset Null
6. Output
7. V<sup>+</sup>
8. Freq. Comp.

#### ORDER PART NOS.

LM101AH/LM301AH

#### V PACKAGE

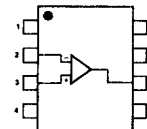

1. Freq. Comp./Offset Null
2. Inverting Input
3. Noninverting Input
4. V<sup>-</sup>
5. Offset Null
6. Output
7. V<sup>+</sup>
8. Freq. Comp.

#### ORDER PART NO.

LM301AN

**SIGNETICS = LM101A/301A – HIGH PERFORMANCE OPERATIONAL AMPLIFIER**

**LM101A**

**ELECTRICAL CHARACTERISTICS** ( $-55^{\circ}\text{C} < T_A < 125^{\circ}\text{C}$ ,  $\pm 5\text{V} < V_S < \pm 20\text{V}$  and  $C_1 = 30\text{pF}$  unless otherwise specified.)

PARAMETER	CONDITIONS	MIN	TYP	MAX	UNITS
Input Offset Voltage	$T_A = 25^{\circ}\text{C}$ , $R_S < 50\text{k}\Omega$		0.7	2.0	mV
Input Offset Current	$T_A = 25^{\circ}\text{C}$		1.5	10	nA
Input Bias Current	$T_A = 25^{\circ}\text{C}$		30	75	nA
Input Resistance	$T_A = 25^{\circ}\text{C}$	1.5	4		M $\Omega$
Supply Current	$T_A = 25^{\circ}\text{C}$ , $V_S = \pm 20\text{V}$		1.8	3.0	mA
Large Signal Voltage Gain	$T_A = 25^{\circ}\text{C}$ , $V_S = \pm 15\text{V}$ $V_{OUT} = \pm 10\text{V}$ , $R_L > 2\text{k}\Omega$	50	160		V/mV
Input Offset Voltage	$R_S < 50\text{k}\Omega$			3.0	mV
Average Temperature Coefficient of Input Offset Voltage			3.0	15	$\mu\text{V}/^{\circ}\text{C}$
Input Offset Current				20	nA
Average Temperature Coefficient of Input Offset Current	$25^{\circ}\text{C} < T_A < 125^{\circ}\text{C}$ $-55^{\circ}\text{C} < T_A < 25^{\circ}\text{C}$		0.01 0.02	0.1 0.2	nA/ $^{\circ}\text{C}$ nA/ $^{\circ}\text{C}$
Input Bias Current				100	nA
Supply Current	$T_A = +125^{\circ}\text{C}$ , $V_S = \pm 20\text{V}$		1.2	2.5	mA
Large Signal Voltage Gain	$V_S = \pm 15\text{V}$ , $V_{OUT} = \pm 10\text{V}$ $R_L > 2\text{k}\Omega$	25			V/mV
Output Voltage Swing	$V_S = \pm 15\text{V}$ , $R_L = 10\text{k}\Omega$ $R_L = 2\text{k}\Omega$	$\pm 12$ $\pm 10$	$\pm 14$ $\pm 13$		V V
Input Voltage Range	$V_S = \pm 20\text{V}$	$\pm 15$			V
Common Mode Rejection Ratio	$R_S < 50\text{k}\Omega$	80	96		dB
Supply Voltage Rejection Ratio	$R_S < 50\text{k}\Omega$	80	96		dB

**LM301A**

**ELECTRICAL CHARACTERISTICS** ( $0^{\circ}\text{C} < T_A < 70^{\circ}\text{C}$ ,  $\pm 5\text{V} < V_S < \pm 15\text{V}$  and  $C_1 = 30\text{pF}$  unless otherwise specified.)

PARAMETER	CONDITIONS	MIN	TYP	MAX	UNIT
Input Offset Voltage	$T_A = 25^{\circ}\text{C}$ , $R_S < 50\text{k}\Omega$		2.0	7.5	mV
Input Offset Current	$T_A = 25^{\circ}\text{C}$		3	50	nA
Input Bias Current	$T_A = 25^{\circ}\text{C}$		70	250	nA
Input Resistance	$T_A = 25^{\circ}\text{C}$	0.6	2		M $\Omega$
Supply Current	$T_A = 25^{\circ}\text{C}$ , $V_S = \pm 15\text{V}$		1.8	3.0	mA
Large Signal Voltage Gain	$T_A = 25^{\circ}\text{C}$ , $V_S = \pm 15\text{V}$ $V_{OUT} = \pm 10\text{V}$ ; $R_L > 2\text{k}\Omega$	25	160		V/mV
Input Offset Voltage	$R_S < 50\text{k}\Omega$			10	mV
Average Temperature Coefficient of Input Offset Voltage			6.0	30	$\mu\text{V}/^{\circ}\text{C}$
Input Offset Current				70	nA
Average Temperature Coefficient of Input Offset Current	$25^{\circ}\text{C} < T_A < 70^{\circ}\text{C}$ $0^{\circ}\text{C} < T_A < 25^{\circ}\text{C}$		0.01 0.02	0.3 0.6	nA/ $^{\circ}\text{C}$ nA/ $^{\circ}\text{C}$
Input Bias Current				300	nA
Large Signal Voltage Gain	$V_S = \pm 15\text{V}$ , $V_{OUT} = \pm 10\text{V}$ $R_L > 2\text{k}\Omega$	15			V/mV
Output Voltage Swing	$V_S = \pm 15\text{V}$ , $R_L = 10\text{k}\Omega$ $R_L = 2\text{k}\Omega$	$\pm 12$ $\pm 10$	$\pm 14$ $\pm 13$		V V
Input Voltage Range	$V_S = \pm 15\text{V}$	$\pm 12$			V
Common Mode Rejection Ratio	$R_S < 50\text{k}\Omega$	70	90		dB
Supply Voltage Rejection Ratio	$R_S < 50\text{k}\Omega$	70	96		dB

TYPICAL CHARACTERISTIC CURVES

LM101A

INPUT VOLTAGE RANGE VERSUS SUPPLY VOLTAGE

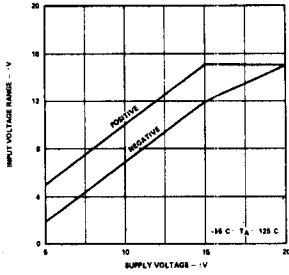

OUTPUT SWING VERSUS SUPPLY VOLTAGE

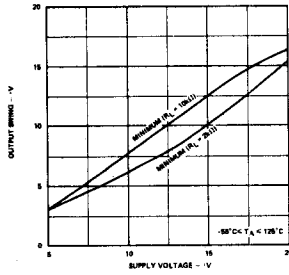

VOLTAGE GAIN VERSUS SUPPLY VOLTAGE

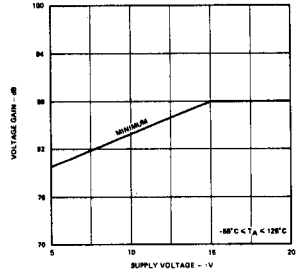

LM301A

INPUT VOLTAGE RANGE VERSUS SUPPLY VOLTAGE

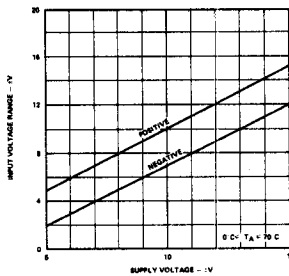

OUTPUT SWING VERSUS SUPPLY VOLTAGE

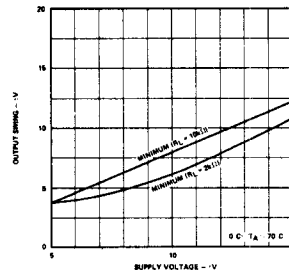

VOLTAGE GAIN VERSUS SUPPLY VOLTAGE

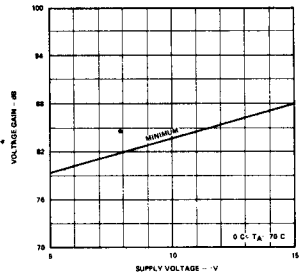

LM101A

VOLTAGE GAIN

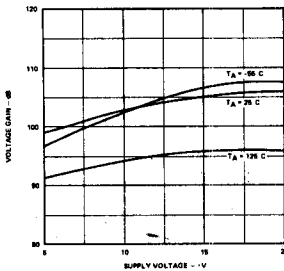

SUPPLY CURRENT

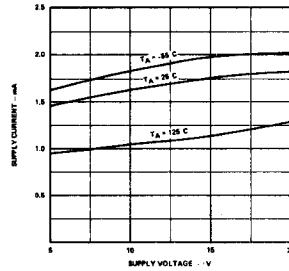

INPUT CURRENT

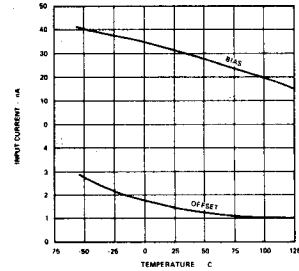

**SIGNETICS - LM101A/301A - HIGH PERFORMANCE OPERATIONAL AMPLIFIER**

**TYPICAL CHARACTERISTIC CURVES (Cont'd.)**

**LM301A**

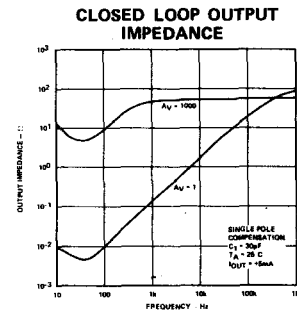
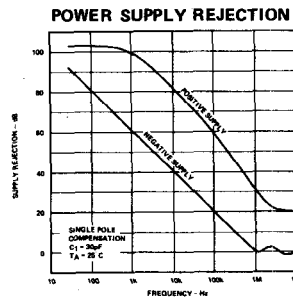
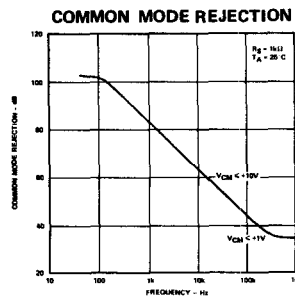
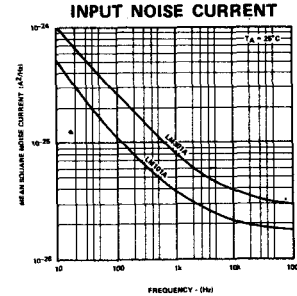
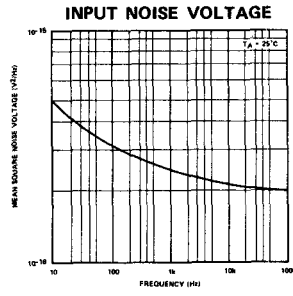
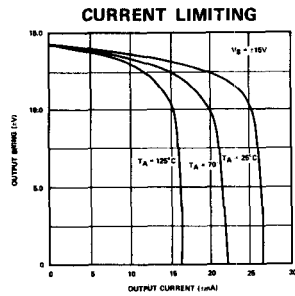
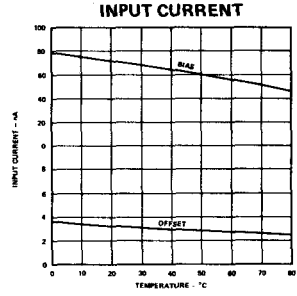
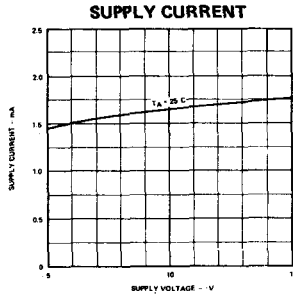
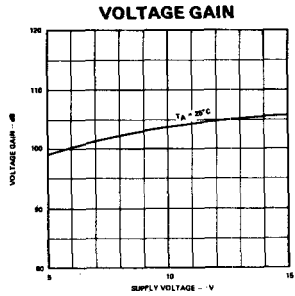

TYPICAL CHARACTERISTIC CURVES (Cont'd.)

SINGLE POLE COMPENSATION

OPEN LOOP FREQUENCY RESPONSE

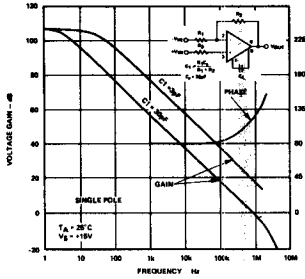

LARGE SIGNAL FREQUENCY RESPONSE

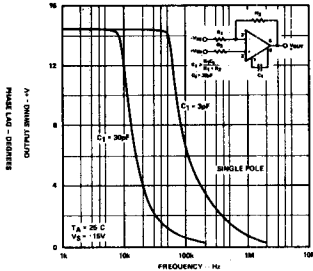

VOLTAGE FOLLOWER PULSE RESPONSE

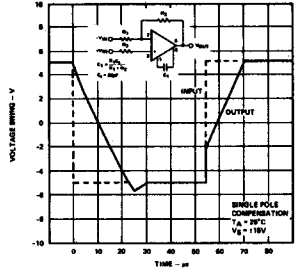

TWO POLE COMPENSATION

OPEN LOOP FREQUENCY RESPONSE

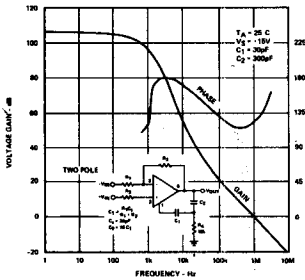

LARGE SIGNAL FREQUENCY RESPONSE

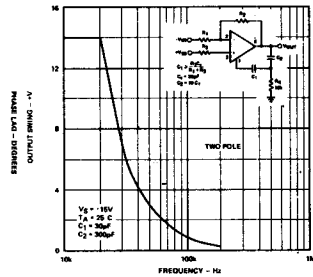

VOLTAGE FOLLOWER PULSE RESPONSE

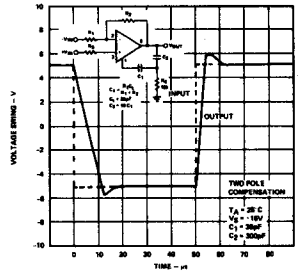

FEED FORWARD COMPENSATION

OPEN LOOP FREQUENCY RESPONSE

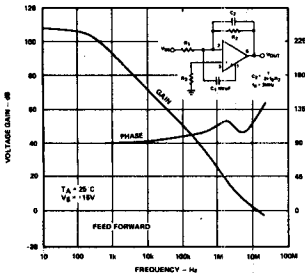

LARGE SIGNAL FREQUENCY RESPONSE

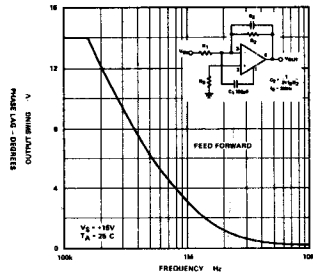

INVERTER PULSE RESPONSE

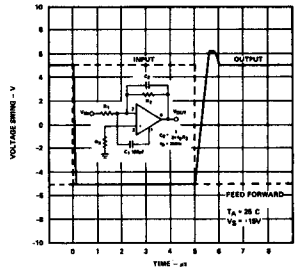

**SIGNETICS ■ LM101A/301A – HIGH PERFORMANCE OPERATIONAL AMPLIFIER**

**TYPICAL APPLICATIONS** (Pin numbers shown refer to T or V package only)

**FAST SUMMING AMPLIFIER**

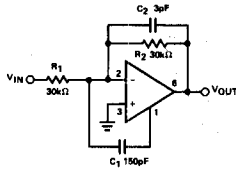

Power Bandwidth: 250kHz  
Small Signal Bandwidth: 3.5MHz  
Slew Rate: 10V/ $\mu$ s

**LOW FREQUENCY SQUARE WAVE GENERATOR**

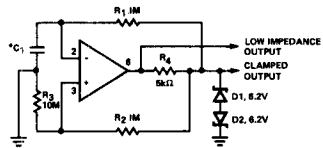

\*Adjust  $C_1$  for frequency

**PRACTICAL DIFFERENTIATOR**

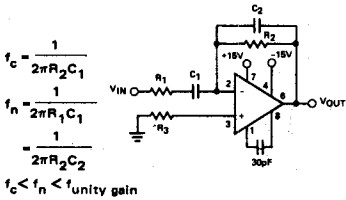

**FREE-RUNNING MULTIVIBRATOR**

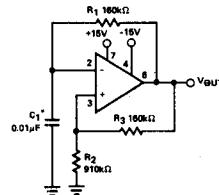

\*Chosen for oscillation at 100Hz

**PULSE WIDTH MODULATOR**

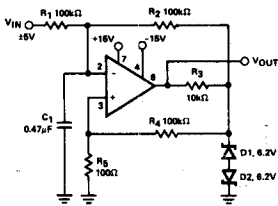

**GAIN TEST CIRCUIT**

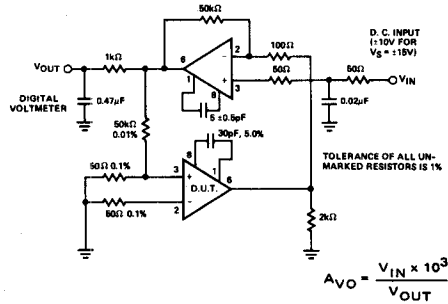

**VOLTAGE COMPARATOR FOR DRIVING RTL LOGIC OR HIGH CURRENT DRIVER**

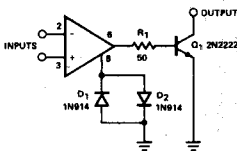

**INVERTING AMPLIFIER WITH BALANCING CIRCUIT**

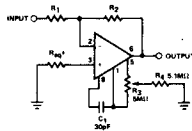

\*May be zero or equal to parallel combination of  $R_1$  and  $R_2$  for minimum offset.

**FAST VOLTAGE FOLLOWER**

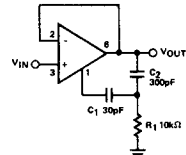

Power Bandwidth: 15KHz  
Slew Rate: 1V/ $\mu$ s