

Small Signal Diode

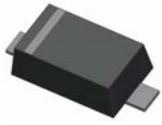

SOD-323

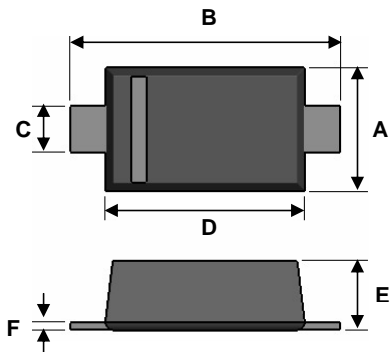

Features

- ↪ Fast switching device ($T_{rr} < 4.0nS$)
- ↪ Surface device type mounting
- ↪ Moisture sensitivity level 1
- ↪ Matte Tin (Sn) lead finish with Nickel (Ni) underplate
- ↪ Pb free version and RoHS compliant
- ↪ Green compound (Halogen free) with suffix "G" on packing code and prefix "G" on date code

Mechanical Data

- ↪ Case : Flat lead SOD-323F small outline plastic package
- ↪ Terminal: Matte tin plated, solderable per MIL-STD-202, Method 208 guaranteed
- ↪ High temperature soldering guaranteed: 260°C/10s
- ↪ Polarity : Indicated by cathode band
- ↪ Weight : 4.85±0.5 mg
- ↪ Marking Code : S1, S2, S3

Dimensions	Unit (mm)		Unit (inch)	
	Min	Max	Min	Max
A	1.15	1.35	0.045	0.053
B	2.30	2.70	0.091	0.106
C	0.25	0.40	0.010	0.016
D	1.60	1.80	0.063	0.071
E	0.80	1.00	0.031	0.039
F	0.05	0.20	0.002	0.008

Ordering Information

Package	Part No.	Packing	Marking
SOD-323F	1N4148WS RR	3K / 7" Reel	S1
SOD-323F	1N4448WS RR	3K / 7" Reel	S2
SOD-323F	1N914BWS RR	3K / 7" Reel	S3
SOD-323F	1N4148WS RRG	3K / 7" Reel	S1
SOD-323F	1N4448WS RRG	3K / 7" Reel	S2
SOD-323F	1N914BWS RRG	3K / 7" Reel	S3

Pin Configuration



Suggested PAD Layout

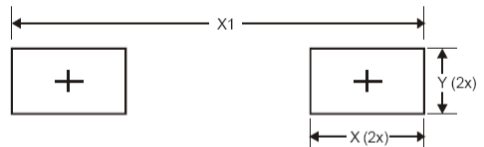

Dimensions	Value (in mm)
X	0.710
X1	2.900
Y	0.403

Maximum Ratings and Electrical Characteristics

Rating at 25°C ambient temperature unless otherwise specified.

Maximum Ratings

Type Number	Symbol	Value	Units
Power Dissipation	P_D	200	mW
Repetitive Peak Reverse Voltage	V_{RRM}	100	V
Reverse Voltage	V_R	100	V
Non-Repetitive Peak Forward Current	I_{FRM}	300	mA
Mean Forward Current	I_o	150	mA
Thermal Resistance (Junction to Ambient)	$R_{\theta JA}$	500	°C/W
Junction and Storage Temperature Range	T_J, T_{STG}	-65 to +150	°C

Notes: 1. The suggested land pattern dimensions have been provided for reference only, as actual pad layouts may vary depending on application.

Small Signal Diode

Electrical Characteristics

Type Number		Symbol	Min	Max	Units
Reverse Breakdown Voltage	$I_R = 100\mu A$	$V_{(BR)}$	100	-	V
	$I_R = 5\mu A$		75	-	
Forward Voltage	1N4448WS, 1N914BWS	V_F	0.62	0.72	V
	1N4148WS		-	1.0	
	1N4448WS, 1N914BWS		-	1.0	
Reverse Leakage Current	$V_R = 20V$	I_R	-	25	nA
	$V_R = 75V$		-	5.0	μA
Junction Capacitance	$V_R = 0, f = 1.0MHz$	C_J	-	4.0	pF
Reverse Recovery Time	$I_F = 10mA, I_R = 60mA, R_L = 100\Omega, I_{RR} = 1mA$	T_{rr}	-	4.0	ns

Tape & Reel specification

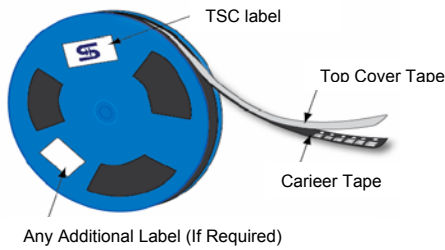

Item	Symbol	Dimension(mm)
Carrier depth	K	2.40 Max.
Sprocket hole	D	1.5 ± 0.1
Reel outside diameter	A	178 ± 1
Reel inner diameter	D1	50 Min.
Feed hole width	D2	13.0 ± 0.5
Sprocket hole position	E	1.75 ± 0.10
Punch hole position	F	3.50 ± 0.05
Sprocket hole pitch	P0	4.00 ± 0.10
Embossment center	P1	2.00 ± 0.10
Overall tape thickness	T	0.6 Max.
Tape width	W	8.30 Max.
Reel width	W1	14.4 Max

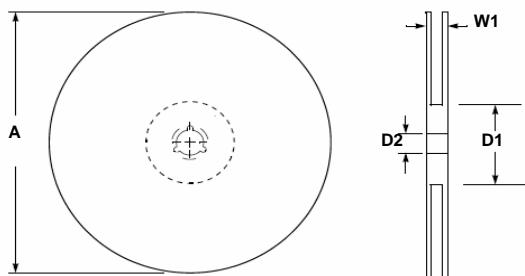
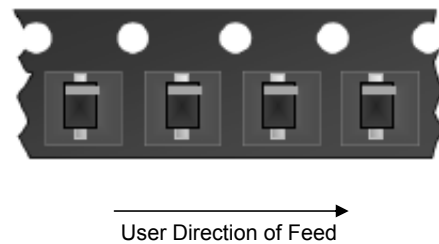
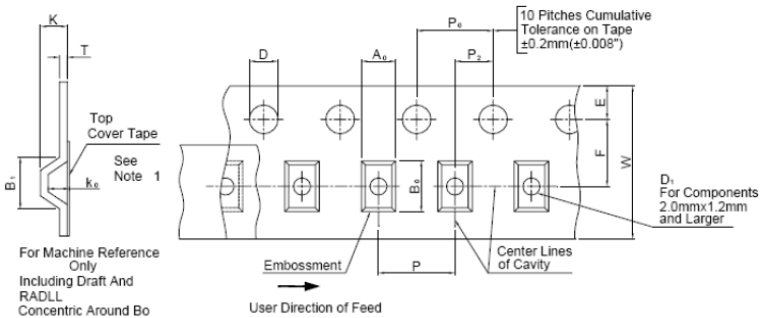

Note 1: A0, B0, and K0 are determined by component size. The clearance between the components and the cavity must be within 0.05 mm min. to 0.5 mm max. The component cannot rotate more than 10° within the determined cavity.

Note 2: If B1 exceeds 4.2 mm(0.165") for 8 mm embossed tape, the tape may not feed through all tape feeders.

Small Signal Diode

Rating and Characteristic Curves

FIG 1 Forward Voltage vs Forward Current

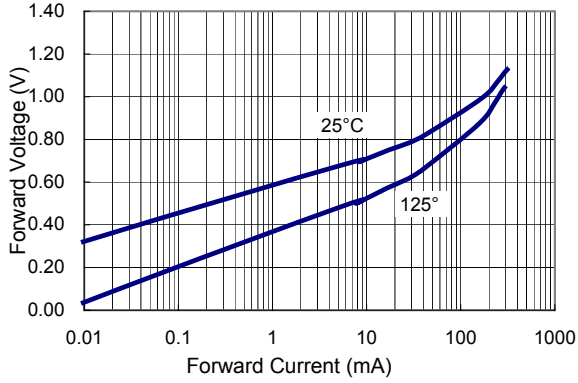

FIG 2 Reverse Current vs Reverse Voltage

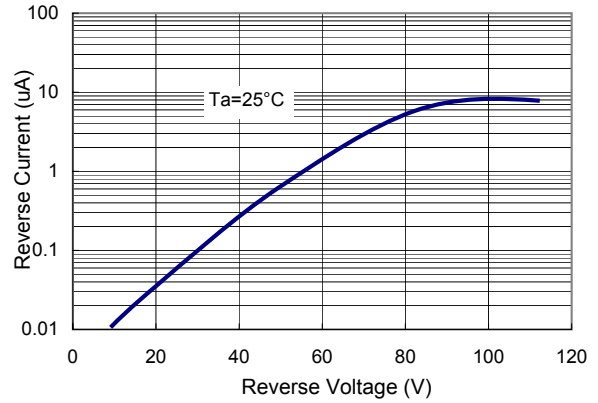

FIG 3 Admissible Power Dissipation Curve

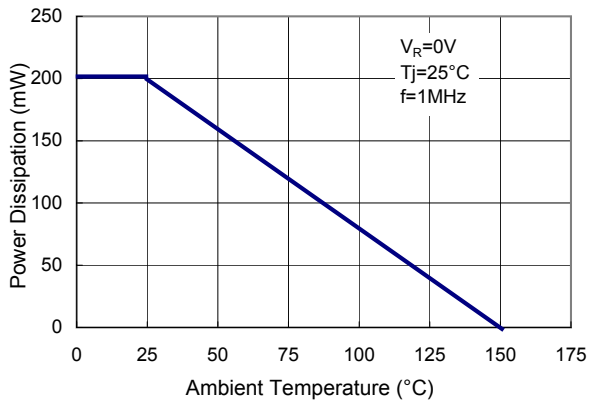

FIG 4 Typical Junction Capacitance

