

MOTOROLA SEMICONDUCTOR TECHNICAL DATA

2

Internally Compensated, High Performance Operational Amplifiers

The MC1741 and MC1741C were designed for use as summing amplifiers, integrators, or amplifiers with operating characteristics as a function of the external feedback components.

- No Frequency Compensation Required
- Short Circuit Protection
- Offset Voltage Null Capability
- Wide Common Mode and Differential Voltage Ranges
- Low Power Consumption
- No Latch Up

MAXIMUM RATINGS ($T_A = +25^\circ\text{C}$, unless otherwise noted.)

Rating	Symbol	MC1741C	MC1741	Unit
Power Supply Voltage	V_{CC}, V_{EE}	± 18	± 22	V_{dc}
Input Differential Voltage	V_{ID}	± 30		V
Input Common Mode Voltage (Note 1)	V_{ICM}	± 15		V
Output Short Circuit Duration (Note 2)	t_{SC}	Continuous		
Operating Ambient Temperature Range	T_A	0 to +70	-55 to +125	$^\circ\text{C}$
Storage Temperature Range Ceramic Package Plastic Package	T_{stg}	-65 to +150 -55 to +125		$^\circ\text{C}$

NOTES: 1. For supply voltages less than +15 V, the absolute maximum input voltage is equal to the supply voltage.

2. Supply voltage equal to or less than 15 V.

Equivalent Circuit Schematic
(1/4 of Circuit Shown)

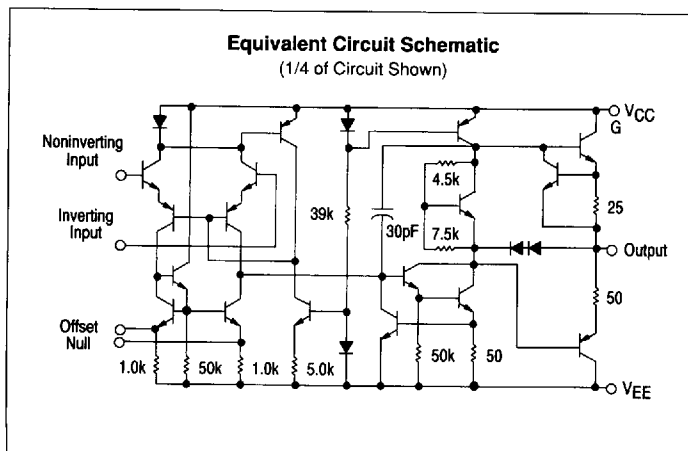

MC1741 MC1741C

OPERATIONAL AMPLIFIERS

SILICON MONOLITHIC
INTEGRATED CIRCUIT



P1 SUFFIX
PLASTIC PACKAGE
CASE 626



U SUFFIX
CERAMIC PACKAGE
CASE 693



D SUFFIX
PLASTIC PACKAGE
CASE 751
(SO-8)

PIN CONNECTIONS

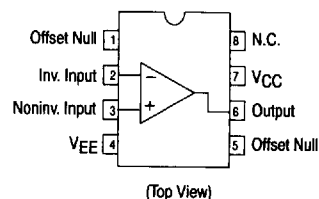

ORDERING INFORMATION

Device	Alternate	Temperature Range	Package
MC1741CD	—	0° to +70°C	SO-8
MC1741CP1	LM741CN, μA741TC		Plastic DIP
MC1741CU	—	-55° to +125°C	Ceramic DIP
MC1741U	—		Ceramic DIP

MC1741, MC1741C

ELECTRICAL CHARACTERISTICS ($V_{CC} = +15\text{ V}$, $V_{EE} = -15\text{ V}$, $T_A = 25^\circ\text{C}$, unless otherwise noted.)

Characteristics	Symbol	MC1741			MC1741C			Unit
		Min	Typ	Max	Min	Typ	Max	
Input Offset Voltage ($R_S \leq 10\text{ k}$)	V_{IO}	—	1.0	5.0	—	2.0	6.0	mV
Input Offset Current	I_{IO}	—	20	200	—	20	200	nA
Input Bias Current	I_{IB}	—	80	500	—	80	500	nA
Input Resistance	r_i	0.3	2.0	—	0.3	2.0	—	M Ω
Input Capacitance	C_i	—	1.4	—	—	1.4	—	pF
Offset Voltage Adjustment Range	V_{IOR}	—	± 15	—	—	± 15	—	mV
Common Mode Input Voltage Range	V_{ICR}	± 12	± 13	—	± 12	± 13	—	V
Large Signal Voltage Gain ($V_O = \pm 10\text{ V}$, $R_L \geq 2.0\text{ k}$)	A_{VOL}	50	200	—	20	200	—	V/mV
Output Resistance	r_o	—	75	—	—	75	—	Ω
Common Mode Rejection ($R_S \leq 10\text{ k}$)	CMR	70	90	—	70	90	—	dB
Supply Voltage Rejection ($R_S \leq 10\text{ k}$)	PSR	75	—	—	75	—	—	dB
Output Voltage Swing ($R_L \geq 10\text{ k}$) ($R_L \geq 2.0\text{ k}$)	V_O	± 12 ± 10	± 14 ± 13	—	± 12 ± 10	± 14 ± 13	—	V
Output Short Circuit Current	I_{SC}	—	20	—	—	20	—	mA
Supply Current	I_D	—	1.7	2.8	—	1.7	2.8	mA
Power Consumption	P_C	—	50	85	—	50	85	mW
Transient Response (Unity Gain, Noninverting) ($V_i = 20\text{ mV}$, $R_L \geq 2.0\text{ k}$, $C_L \leq 100\text{ pF}$) Rise Time ($V_i = 20\text{ mV}$, $R_L \geq 2.0\text{ k}$, $C_L \leq 100\text{ pF}$) Overshoot ($V_i = 10\text{ V}$, $R_L \geq 2.0\text{ k}$, $C_L \leq 100\text{ pF}$) Slew Rate	t_{LH} os SR	—	0.3 15 0.5	—	—	0.3 15 0.5	—	μs % V/ μs

ELECTRICAL CHARACTERISTICS ($V_{CC} = +15\text{ V}$, $V_{EE} = -15\text{ V}$, $T_A = T_{low}$ to T_{high} , unless otherwise noted.)*

Characteristics	Symbol	MC1741			MC1741C			Unit
		Min	Typ	Max	Min	Typ	Max	
Input Offset Voltage ($R_S \leq 10\text{ k}\Omega$)	V_{IO}	—	1.0	6.0	—	—	7.5	mV
Input Offset Current ($T_A = +125^\circ\text{C}$) ($T_A = -55^\circ\text{C}$) ($T_A = 0^\circ$ to $+70^\circ\text{C}$)	I_{IO}	—	7.0 85 —	200 500 —	—	—	— — 300	nA
Input Bias Current ($T_A = +125^\circ\text{C}$) ($T_A = -55^\circ\text{C}$) ($T_A = 0^\circ$ to $+70^\circ\text{C}$)	I_{IB}	—	30 300 —	500 1500 —	—	—	— — 800	nA
Common Mode Input Voltage Range	V_{ICR}	± 12	± 13	—	—	—	—	V
Common Mode Rejection ($R_S \leq 10\text{ k}$)	CMR	70	90	—	—	—	—	dB
Supply Voltage Rejection ($R_S \leq 10\text{ k}$)	PSR	75	—	—	75	—	—	dB
Output Voltage Swing ($R_L \geq 10\text{ k}$) ($R_L \geq 2.0\text{ k}$)	V_O	± 12 ± 10	± 14 ± 13	—	—	± 13	—	V
Large Signal Voltage Gain ($R_L \geq 2.0\text{ k}$, $V_O = \pm 10\text{ V}$)	A_{VOL}	25	—	—	15	—	—	V/mV
Supply Currents ($T_A = +125^\circ\text{C}$) ($T_A = -55^\circ\text{C}$)	I_D	—	1.5 2.0	2.5 3.3	—	—	—	mA
Power Consumption ($T_A = +125^\circ\text{C}$) ($T_A = -55^\circ\text{C}$)	P_C	—	45 60	75 100	—	—	—	mW

$T_{high} = 125^\circ\text{C}$ for MC1741
70 $^\circ\text{C}$ for MC1741C

* $T_{low} = -55^\circ\text{C}$ for MC1741
0 $^\circ\text{C}$ for MC1741C

MC1741, MC1741C

2

Figure 1. Burst Noise versus Source Resistance

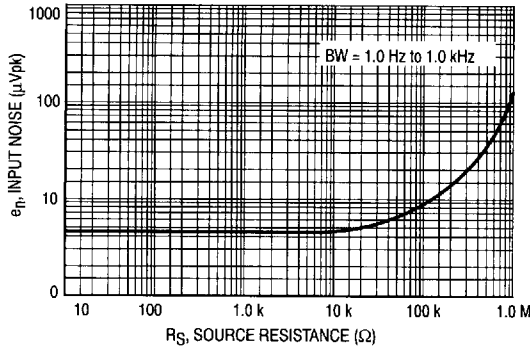

Figure 2. RMS Noise versus Source Resistance

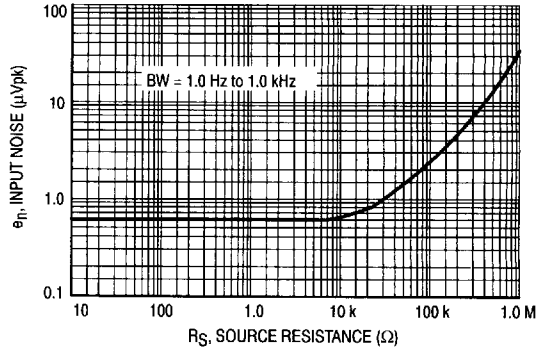

Figure 3. Output Noise versus Source Resistance

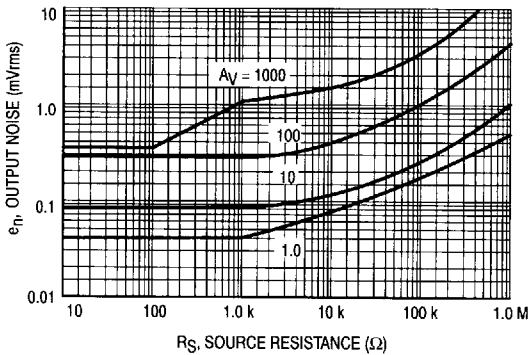

Figure 4. Spectral Noise Density

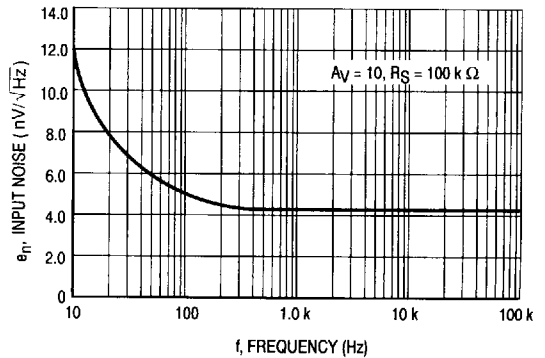
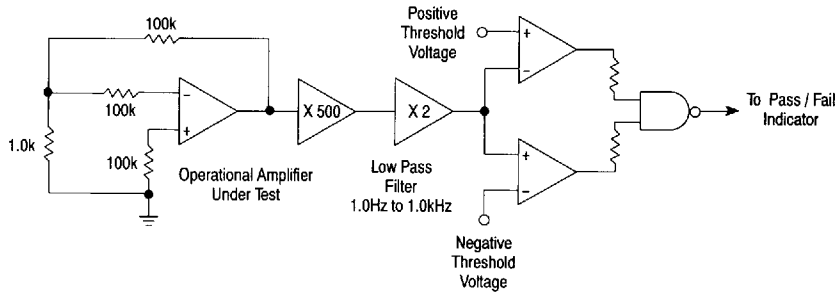

Figure 5. Burst Noise Test Circuit



Unlike conventional peak reading or RMS meters, this system was especially designed to provide the quick response time essential to burst (popcorn) noise testing.

The test time employed is 10 sec and the 20 mV peak limit refers to the operational amplifier input thus eliminating errors in the closed-loop gain factor of the operational amplifier.

MC1741, MC1741C

Figure 6. Power Bandwidth
(Large Signal Swing versus Frequency)

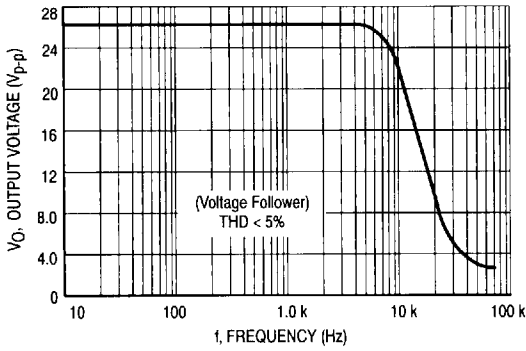

Figure 7. Open-Loop Frequency Response

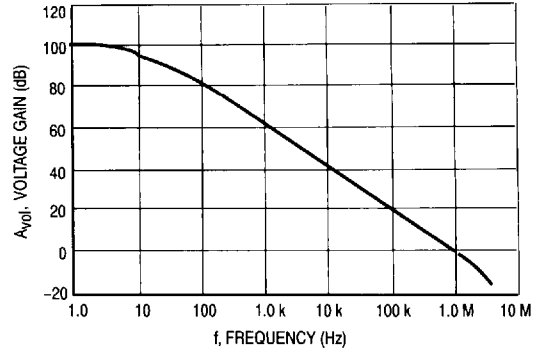

Figure 8. Positive Output Voltage Swing
versus Load Resistance

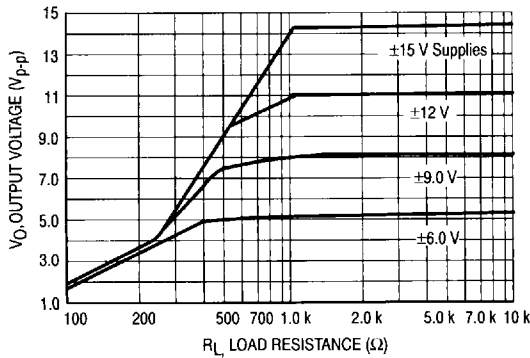

Figure 9. Negative Output Voltage Swing
versus Load Resistance

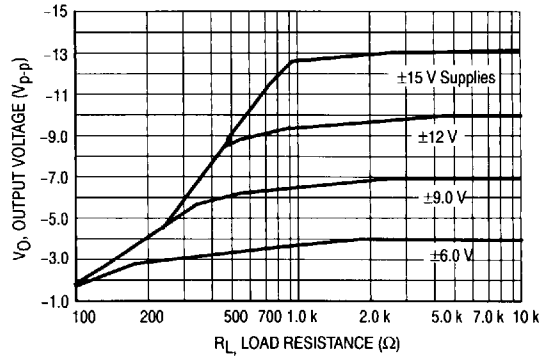

Figure 10. Output Voltage Swing versus
Load Resistance (Single Supply Operation)

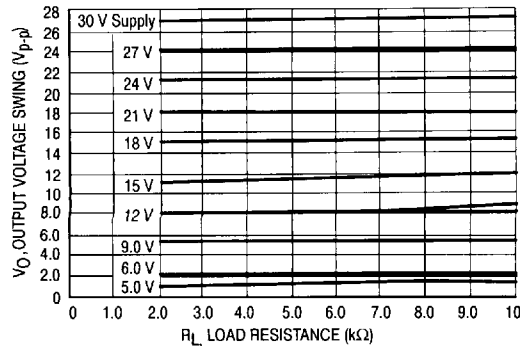
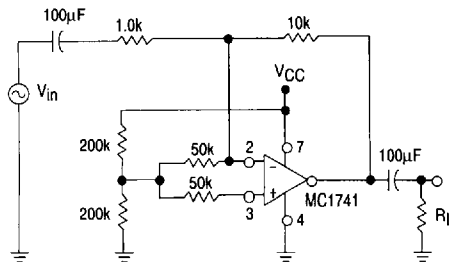
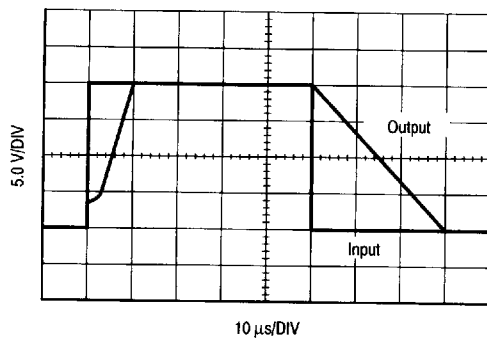
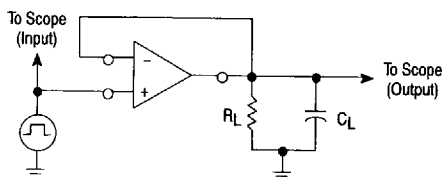

Figure 11. Single Supply Inverting Amplifier



MC1741, MC1741C**Figure 12. Noninverting Pulse Response****Figure 13. Transient Response Test Circuit****Figure 14. Open-Loop Voltage Gain versus Supply Voltage**