

LM2931

Series Low Dropout Regulators

General Description

The LM2931 positive voltage regulator features a very low quiescent current of 1mA or less when supplying 10mA loads. This unique characteristic and the extremely low input-output differential required for proper regulation (0.2V for output currents of 10mA) make the LM2931 the ideal regulator for standby power systems. Applications include memory standby by circuits, CMOS and other low power processor power supplies as well as systems demanding as much as 100mA of output current.

Designed originally for automotive applications, the LM2931 and all regulated circuitry are protected from reverse battery installations or 2 battery jumps. During line transients, such as a load dump (60V) when the input voltage to the regulator can momentarily exceed the specified maximum operating voltage, the regulator will automatically shut down to protect both internal circuits and the load. The LM2931 cannot be harmed by temporary mirror-image insertion. Familiar regulator features such as short circuit and thermal overload protection are also provided.

The LM2931 family includes a fixed 5V output ($\pm 3.8\%$ tolerance for A grade) or an adjustable output with ON/OFF pin.

Both versions are available in a TO-220 power package, TO-263 surface mount package, and an 8-lead surface mount package. The fixed output version is also available in the TO-92 plastic and 6-Bump micro SMD packages.

Features

- Very low quiescent current
- Output current in excess of 100 mA
- Input-output differential less than 0.6V
- Reverse battery protection
- 60V load dump protection
- -50V reverse transient protection
- Short circuit protection
- Internal thermal overload protection
- Mirror-image insertion protection
- Available in TO-220, TO-92, TO-263, SO-8 or 6-Bump micro SMD packages
- Available as adjustable with TTL compatible switch
- See AN-1112 for micro SMD considerations

Connection Diagrams

FIXED VOLTAGE OUTPUT

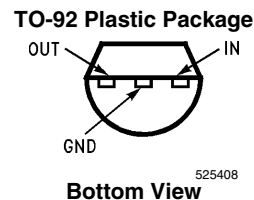
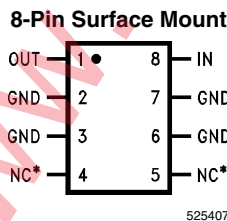
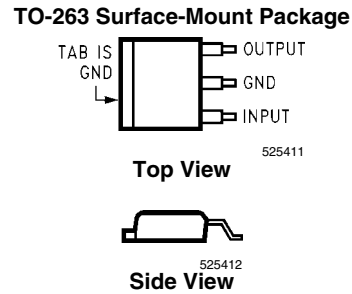
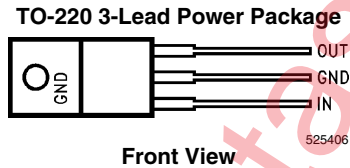

*NC = Not internally connected. Must be electrically isolated from the rest of the circuit for the micro SMD package.

Top View

6-Bump micro SMD

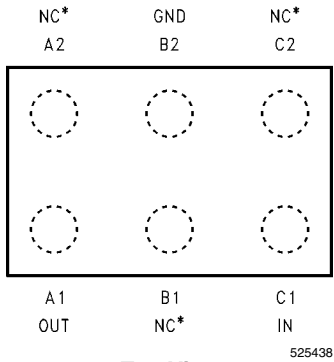

**Top View
(Bump Side Down)**

micro SMD Laser Mark

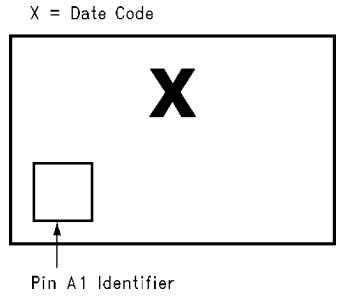

ADJUSTABLE OUTPUT VOLTAGE

TO-220 5-Lead Power Package

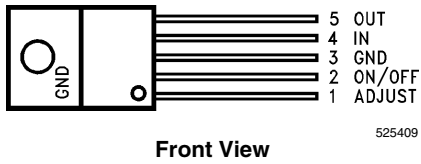

Front View

**TO-263
5-Lead Surface-Mount Package**

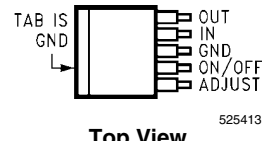

Top View



Side View

8-Pin Surface Mount

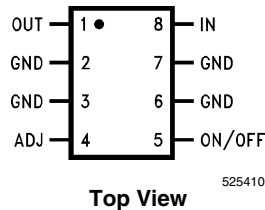

Top View

Ordering Information

Output Number	Package	Part Number	Package Marking	Transport Media	NSC Drawing
5V	3-Pin TO-220	LM2931T-5.0	LM2931T-5.0	Rails	T03B
		LM2931AT-5.0	LM2931AT-5.0	Rails	
	3-Pin TO-263	LM2931S-5.0	LM2931S-5.0	Rails	TS3B
		LM2931AS-5.0	LM2931AS-5.0	Rails	
	TO-92	LM2931Z-5.0	LM2931Z-5	1.8k Units per Box	Z03A
		LM2931AZ-5.0	LM2931AZ	1.8k Units per Box	
	8-Pin SOIC	LM2931M-5.0	2931M-5.0	Rails	M08A
LM2931AM-5.0		2931AM-5.0	Rails		
* 6-Bump micro SMD	LM2931BPX-5.0	-	Tape and Reel	BPA06HTA	
Adjustable, 3V to 24V	5-Pin TO-220	LM2931CT	LM2931CT	Rails	T05A
	5-Pin TO-263	LM2931CS	LM2931CS	Rails	TS5B
	8-Pin SOIC	LM2931CM	LM2931CM	Rails	M08A
3.3V	* 6-Bump micro SMD	LM2931BPX-3.3	-	Tape and Reel	BPA06HTB

Note: The micro SMD package marking is a single digit manufacturing Date Code Only.

Typical Applications

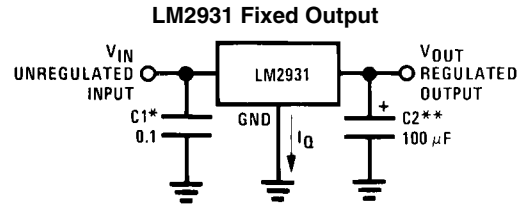

525404

*Required if regulator is located far from power supply filter.

**C2 must be at least 100 μF to maintain stability. May be increased without bound to maintain regulation during transients. Locate as close as possible to the regulator. This capacitor must be rated over the same operating temperature range as the regulator. The equivalent series resistance (ESR) of this capacitor is critical; see curve.

LM2931 Adjustable Output

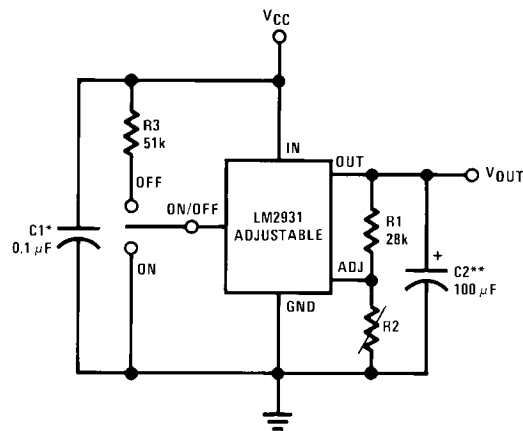

525405

$$V_{\text{OUT}} = \text{Reference Voltage} \times \frac{R1 + R2}{R1}$$

Note: Using 27k for R1 will automatically compensate for errors in V_{OUT} due to the input bias current of the ADJ pin (approximately 1 μA).

Absolute Maximum Ratings (Note 1)

If Military/Aerospace specified devices are required, please contact the National Semiconductor Sales Office/Distributors for availability and specifications.

Input Voltage	
Operating Range	26V
Overvoltage Protection	
LM2931A, LM2931C (Adjustable)	60V

LM2931	50V
Internal Power Dissipation	Internally Limited
(Notes 2, 4)	
Operating Ambient Temperature	
Range	-40°C to +85°C
Maximum Junction Temperature	125°C
Storage Temperature Range	-65°C to +150°C
Lead Temp. (Soldering, 10 seconds)	230°C
ESD Tolerance (Note 5)	2000V

Electrical Characteristics for Fixed 3.3V Version

$V_{IN} = 14V$, $I_O = 10mA$, $T_J = 25^\circ C$, $C_2 = 100\mu F$ (unless otherwise specified) (Note 2)

Parameter	Conditions	LM2931-3.3		Units
		Typ	Limit (Note 3)	
Output Voltage		3.3	3.465 3.135	V_{MAX} V_{MIN}
	$4V \leq V_{IN} \leq 26V$, $I_O = 100 mA$ $-40^\circ C \leq T_J \leq 125^\circ C$		3.630 2.970	V_{MAX} V_{MIN}
Line Regulation	$4V \leq V_{IN} \leq 26V$	4	33	mV_{MAX}
Load Regulation	$5mA \leq I_O \leq 100mA$	10	50	mV_{MAX}
Output Impedance	$100mA_{DC}$ and $10mA_{rms}$, 100Hz - 10kHz	200		$m\Omega$
Quiescent Current	$I_O \leq 10mA$, $4V \leq V_{IN} \leq 26V$ $-40^\circ C \leq T_J \leq 125^\circ C$	0.4	1.0	mA_{MAX}
	$I_O = 100mA$, $V_{IN} = 14V$, $T_J = 25^\circ C$	15		mA
Output Noise Voltage	10Hz -100kHz, $C_{OUT} = 100\mu F$	330		μV_{rms}
Long Term Stability		13		$mV/1000 hr$
Ripple Rejection	$f_O = 120Hz$	80		dB
Dropout Voltage	$I_O = 10mA$	0.05	0.2	V_{MAX}
	$I_O = 100mA$	0.30	0.6	
Maximum Operational Input Voltage		33	26	V_{MIN}
Maximum Line Transient	$R_L = 500\Omega$, $V_O \leq 5.5V$, $T = 1ms$, $\tau \leq 100ms$	70	50	V_{MIN}
Reverse Polarity Input Voltage, DC	$V_O \geq -0.3V$, $R_L = 500\Omega$	-30	-15	V_{MIN}
Reverse Polarity Input Voltage, Transient	$T = 1ms$, $\tau \leq 100ms$, $R_L = 500\Omega$	-80	-50	V_{MIN}

Electrical Characteristics for Fixed 5V Version

$V_{IN} = 14V$, $I_O = 10mA$, $T_J = 25^\circ C$, $C_2 = 100 \mu F$ (unless otherwise specified) (Note 2)

Parameter	Conditions	LM2931A-5.0		LM2931-5.0		Units
		Typ	Limit (Note 3)	Typ	Limit (Note 3)	
Output Voltage		5	5.19 4.81	5	5.25 4.75	V_{MAX} V_{MIN}
	$6.0V \leq V_{IN} \leq 26V$, $I_O = 100mA$ $-40^\circ C \leq T_J \leq 125^\circ C$		5.25 4.75		5.5 4.5	V_{MAX} V_{MIN}
Line Regulation	$9V \leq V_{IN} \leq 16V$	2	10	2	10	mV_{MAX}
	$6V \leq V_{IN} \leq 26V$	4	30	4	30	
Load Regulation	$5 mA \leq I_O \leq 100mA$	14	50	14	50	mV_{MAX}
Output Impedance	$100mA_{DC}$ and $10mA_{rms}$, 100Hz -10kHz	200		200		$m\Omega$
Quiescent Current	$I_O \leq 10mA$, $6V \leq V_{IN} \leq 26V$ $-40^\circ C \leq T_J \leq 125^\circ C$	0.4	1.0	0.4	1.0	mA_{MAX}
	$I_O = 100mA$, $V_{IN} = 14V$, $T_J = 25^\circ C$	15	30 5	15		mA_{MAX} mA_{MIN}
Output Noise Voltage	10Hz -100kHz, $C_{OUT} = 100\mu F$	500		500		μV_{rms}
Long Term Stability		20		20		$mV/1000$ hr
Ripple Rejection	$f_O = 120 Hz$	80	55	80		dB_{MIN}
Dropout Voltage	$I_O = 10mA$	0.05	0.2	0.05	0.2	V_{MAX}
	$I_O = 100mA$	0.3	0.6	0.3	0.6	
Maximum Operational Input Voltage		33	26	33	26	V_{MIN}
Maximum Line Transient	$R_L = 500\Omega$, $V_O \leq 5.5V$, $T = 1ms$, $\tau \leq 100ms$	70	60	70	50	V_{MIN}
Reverse Polarity Input Voltage, DC	$V_O \geq -0.3V$, $R_L = 500\Omega$	-30	-15	-30	-15	V_{MIN}
Reverse Polarity Input Voltage, Transient	$T = 1ms$, $\tau \leq 100ms$, $R_L = 500\Omega$	-80	-50	-80	-50	V_{MIN}

Note 1: Absolute Maximum Ratings indicate limits beyond which damage to the device may occur. Electrical specifications do not apply when operating the device beyond its rated operating conditions.

Note 2: See circuit in Typical Applications. To ensure constant junction temperature, low duty cycle pulse testing is used.

Note 3: All limits are guaranteed for $T_J = 25^\circ C$ (standard type face) or over the full operating junction temperature range of $-40^\circ C$ to $+125^\circ C$ (bold type face).

Note 4: The maximum power dissipation is a function of maximum junction temperature T_{Jmax} , total thermal resistance θ_{JA} , and ambient temperature T_A . The maximum allowable power dissipation at any ambient temperature is $P_D = (T_{Jmax} - T_A)/\theta_{JA}$. If this dissipation is exceeded, the die temperature will rise above $150^\circ C$ and the LM2931 will go into thermal shutdown. For the LM2931 in the TO-92 package, θ_{JA} is $195^\circ C/W$; in the SO-8 package, θ_{JA} is $160^\circ C/W$, and in the TO-220 package, θ_{JA} is $50^\circ C/W$; in the TO-263 package, θ_{JA} is $73^\circ C/W$; and in the 6-Bump micro SMD package θ_{JA} is $290^\circ C/W$. If the TO-220 package is used with a heat sink, θ_{JA} is the sum of the package thermal resistance junction-to-case of $3^\circ C/W$ and the thermal resistance added by the heat sink and thermal interface.

If the TO-263 package is used, the thermal resistance can be reduced by increasing the P.C. board copper area thermally connected to the package: Using 0.5 square inches of copper area, θ_{JA} is $50^\circ C/W$; with 1 square inch of copper area, θ_{JA} is $37^\circ C/W$; and with 1.6 or more square inches of copper area, θ_{JA} is $32^\circ C/W$.

Note 5: Human body model, 100 pF discharged through 1.5 kΩ.

Electrical Characteristics for Adjustable Version

$V_{IN} = 14V$, $V_{OUT} = 3V$, $I_O = 10\text{ mA}$, $T_J = 25^\circ\text{C}$, $R_1 = 27k$, $C_2 = 100\text{ }\mu\text{F}$ (unless otherwise specified) (Note 2)

Parameter	Conditions	Typ	Limit	Units Limit
Reference Voltage		1.20	1.26 1.14	V_{MAX} V_{MIN}
	$I_O \leq 100\text{ mA}$, $-40^\circ\text{C} \leq T_J \leq 125^\circ\text{C}$, $R_1 = 27k$ Measured from V_{OUT} to Adjust Pin		1.32 1.08	V_{MAX} V_{MIN}
Output Voltage Range			24 3	V_{MAX} V_{MIN}
Line Regulation	$V_{OUT} + 0.6V \leq V_{IN} \leq 26V$	0.2	1.5	mV/V_{MAX}
Load Regulation	$5\text{ mA} \leq I_O \leq 100\text{ mA}$	0.3	1	$\%_{MAX}$
Output Impedance	100 mA_{DC} and 10 mA_{rms} , 100 Hz–10 kHz	40		$\text{m}\Omega/V$
Quiescent Current	$I_O = 10\text{ mA}$	0.4	1	mA_{MAX}
	$I_O = 100\text{ mA}$	15		mA
	During Shutdown $R_L = 500\Omega$	0.8	1	mA_{MAX}
Output Noise Voltage	10 Hz–100 kHz	100		$\mu\text{V}_{rms}/V$
Long Term Stability		0.4		$\%/1000\text{ hr}$
Ripple Rejection	$f_O = 120\text{ Hz}$	0.02		$\%/V$
Dropout Voltage	$I_O \leq 10\text{ mA}$	0.05	0.2	V_{MAX}
	$I_O = 100\text{ mA}$	0.3	0.6	V_{MAX}
Maximum Operational Input Voltage		33	26	V_{MIN}
Maximum Line Transient	$I_O = 10\text{ mA}$, Reference Voltage $\leq 1.5V$ $T = 1\text{ ms}$, $\tau \leq 100\text{ ms}$	70	60	V_{MIN}
Reverse Polarity Input Voltage, DC	$V_O \geq -0.3V$, $R_L = 500\Omega$	-30	-15	V_{MIN}
Reverse Polarity Input Voltage, Transient	$T = 1\text{ ms}$, $\tau \leq 100\text{ ms}$, $R_L = 500\Omega$	-80	-50	V_{MIN}
On/Off Threshold Voltage	$V_O = 3V$	2.0	1.2	V_{MAX}
		2.2	3.25	V_{MIN}
On/Off Threshold Current		20	50	μA_{MAX}

Typical Performance Characteristics

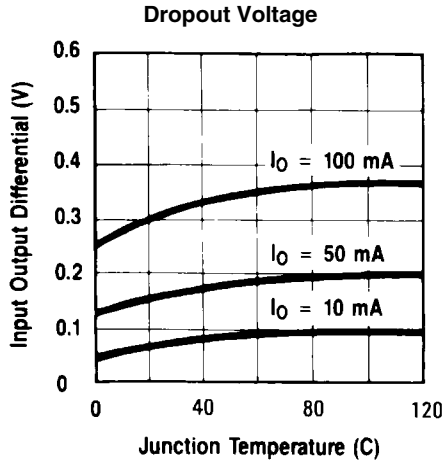

525416

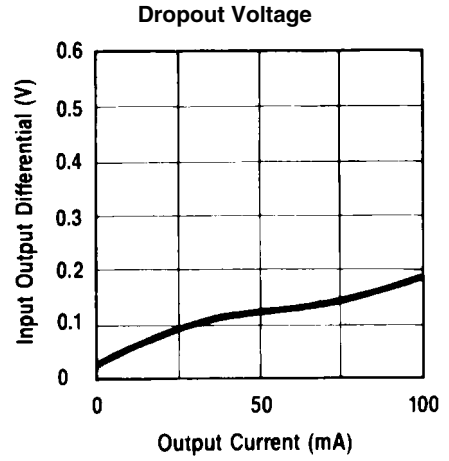

525417

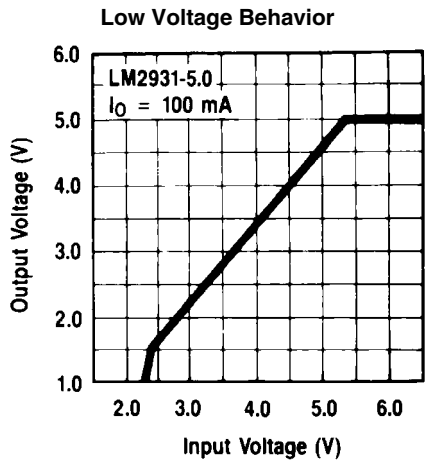

525418

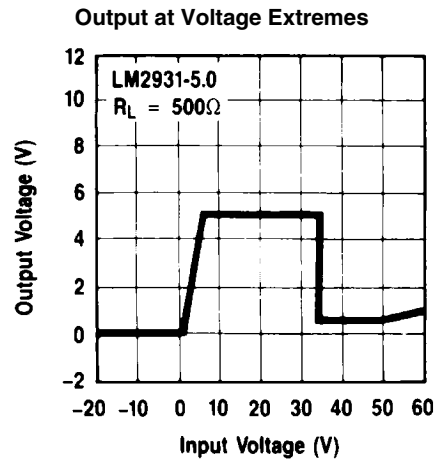

525419

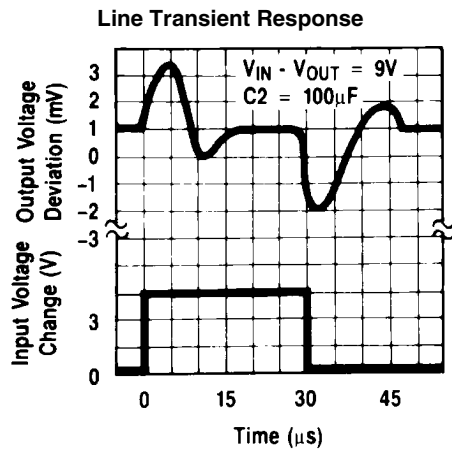

525420

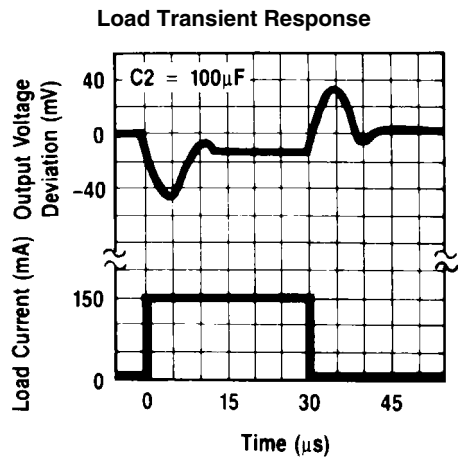

525421

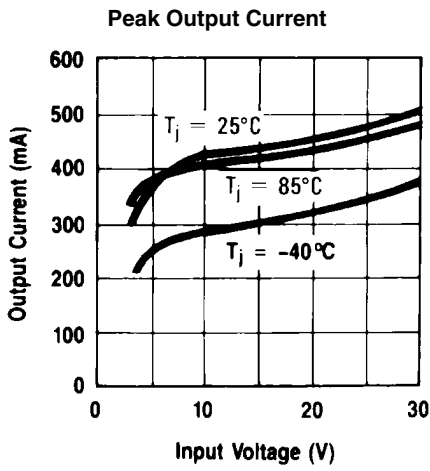

525422

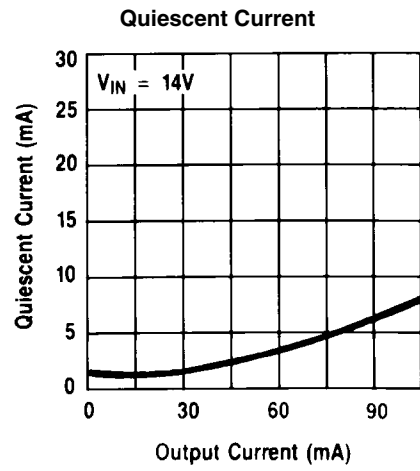

525423

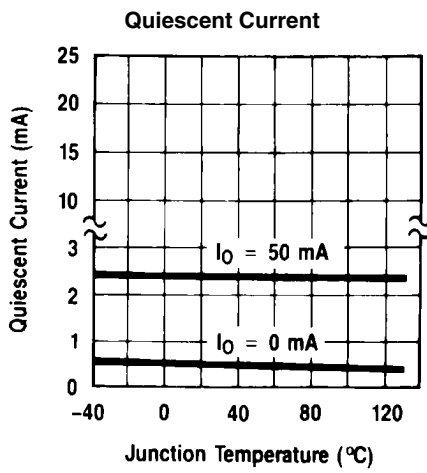

525424

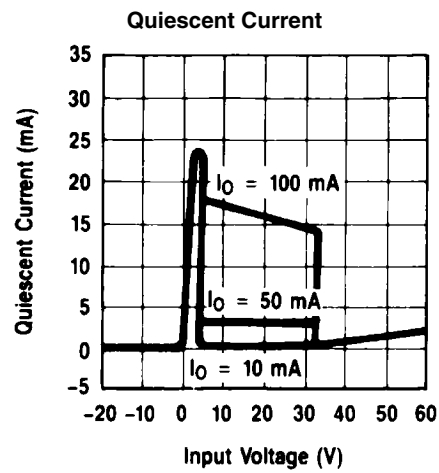

525425

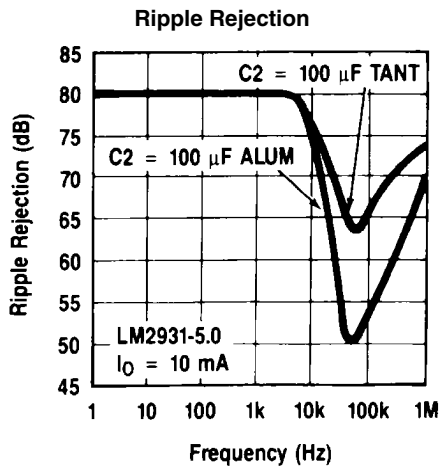

525426

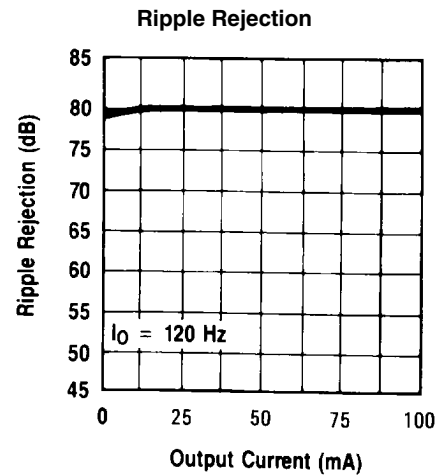

525427

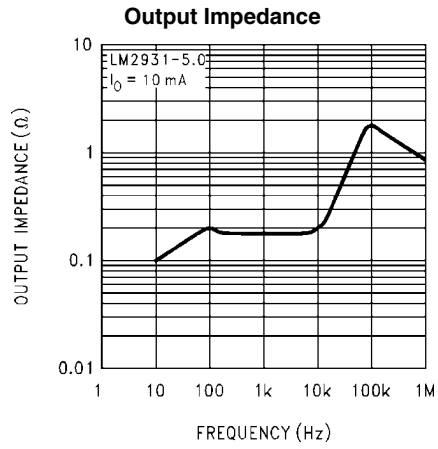

525428

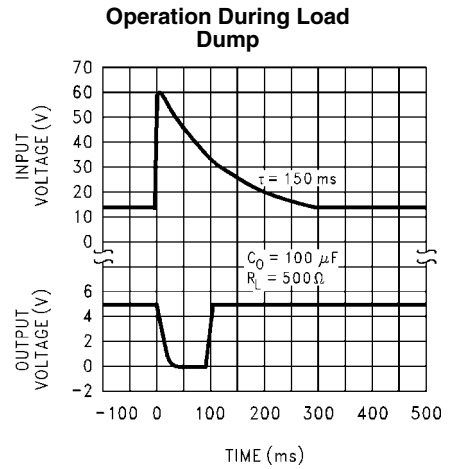

525429

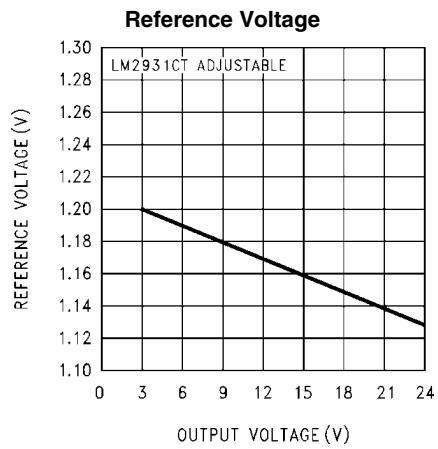

525430

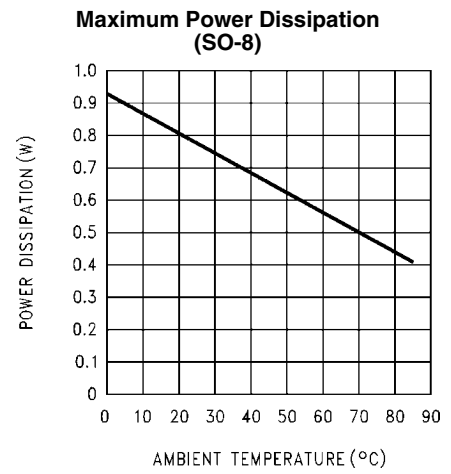

525431

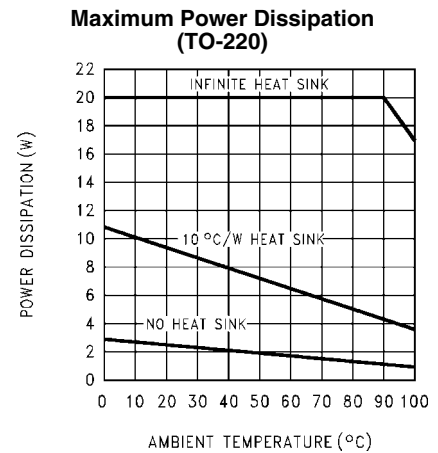

525432

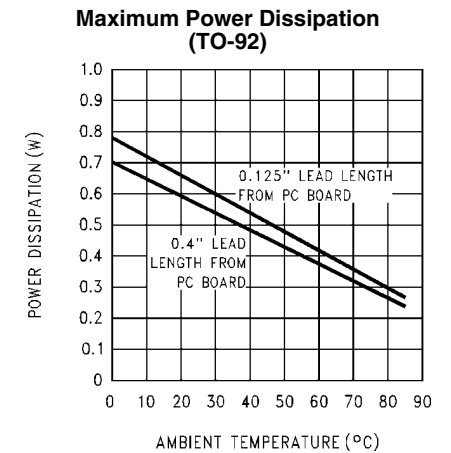

525433

**Maximum Power Dissipation
(TO-263) (Note 4)**

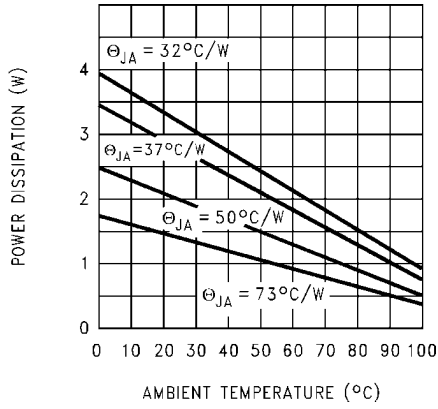

525434

On/Off Threshold

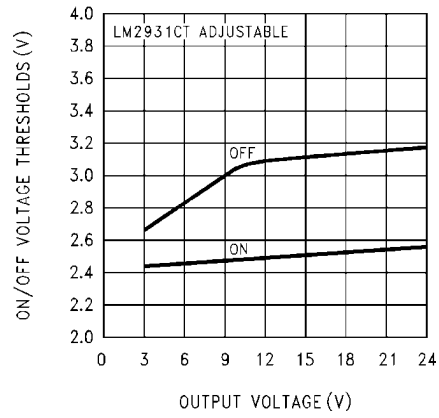

525435

Output Capacitor ESR

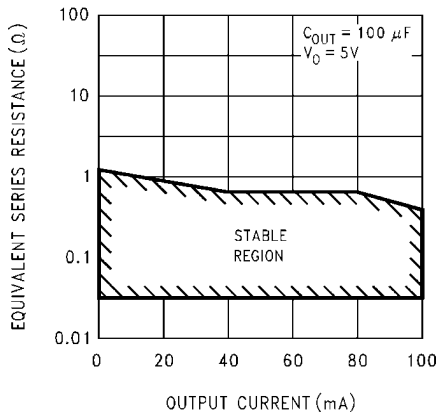

525436

Schematic Diagram

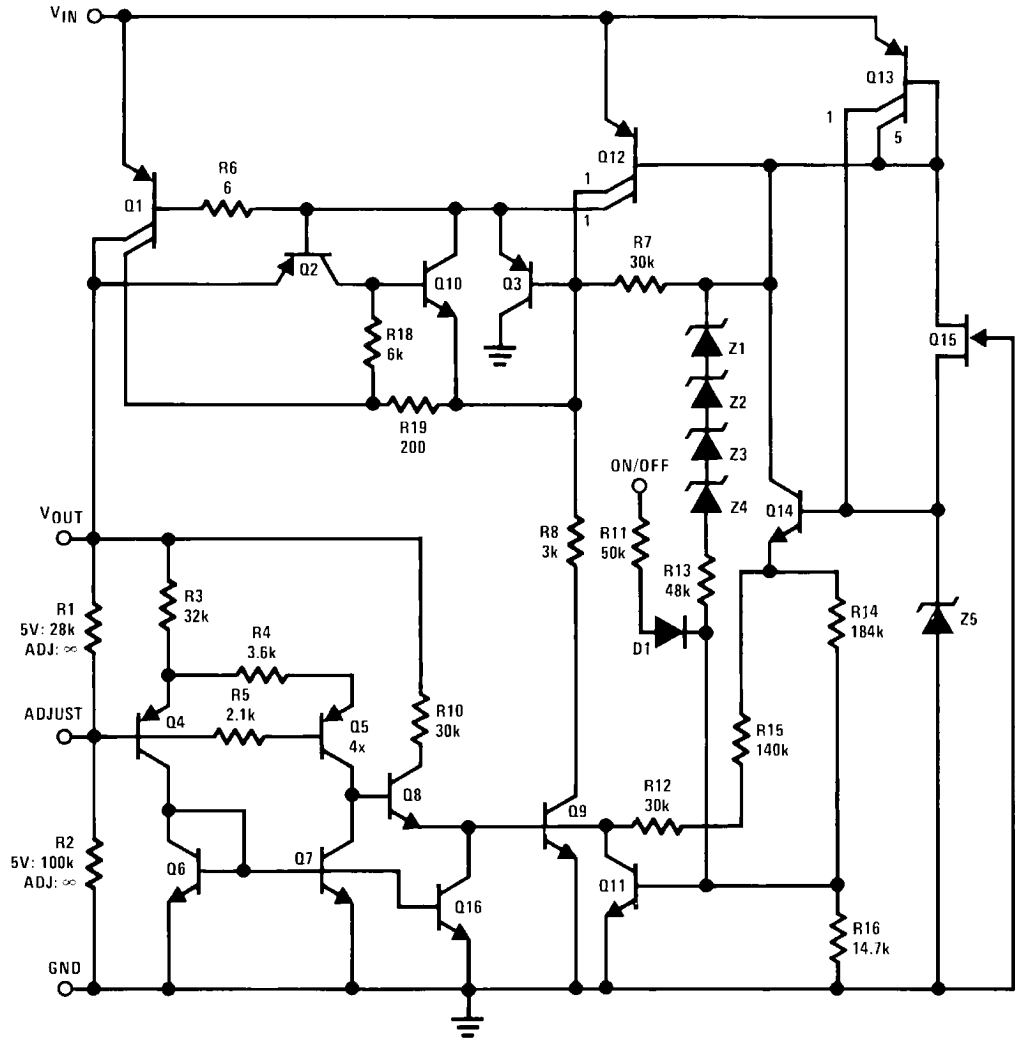

525401

Application Hints

One of the distinguishing factors of the LM2931 series regulators is the requirement of an output capacitor for device stability. The value required varies greatly depending upon the application circuit and other factors. Thus some comments on the characteristics of both capacitors and the regulator are in order.

High frequency characteristics of electrolytic capacitors depend greatly on the type and even the manufacturer. As a result, a value of capacitance that works well with the LM2931 for one brand or type may not necessary be sufficient with an electrolytic of different origin. Sometimes actual bench testing, as described later, will be the only means to determine the proper capacitor type and value. Experience has shown that, as a rule of thumb, the more expensive and higher quality electrolytics generally allow a smaller value for regulator stability. As an example, while a high-quality 100 μF aluminum electrolytic covers all general application circuits, similar stability can be obtained with a tantalum electrolytic of only 47 μF . This factor of two can generally be applied to any special application circuit also.

Another critical characteristic of electrolytics is their performance over temperature. While the LM2931 is designed to operate to -40°C , the same is not always true with all electrolytics (hot is generally not a problem). The electrolyte in many aluminum types will freeze around -30°C , reducing their effective value to zero. Since the capacitance is needed for regulator stability, the natural result is oscillation (and lots of it) at the regulator output. For all application circuits where cold operation is necessary, the output capacitor must be rated to operate at the minimum temperature. By coincidence, worst-case stability for the LM2931 also occurs at minimum temperatures. As a result, in applications where the regulator junction temperature will never be less than 25°C , the output capacitor can be reduced approximately by a factor of two over the value needed for the entire temperature range. To continue our example with the tantalum electrolytic, a value of only 22 μF would probably thus suffice. For high-quality aluminum, 47 μF would be adequate in such an application.

Another regulator characteristic that is noteworthy is that stability decreases with higher output currents. This sensible fact has important connotations. In many applications, the LM2931 is operated at only a few milliamps of output current or less. In such a circuit, the output capacitor can be further reduced in value. As a rough estimation, a circuit that is required to deliver a maximum of 10mA of output current from the regulator would need an output capacitor of only half the value compared to the same regulator required to deliver the full output current of 100mA. If the example of the tantalum capacitor in the circuit rated at 25°C junction temperature and above were continued to include a maximum of 10mA of output current, then the 22 μF output capacitor could be reduced to only 10 μF .

In the case of the LM2931CT adjustable regulator, the minimum value of output capacitance is a function of the output voltage. As a general rule, the value decreases with higher output voltages, since internal loop gain is reduced.

At this point, the procedure for bench testing the minimum value of an output capacitor in a special application circuit should be clear. Since worst-case occurs at minimum operating temperatures and maximum operating currents, the entire circuit, including the electrolytic, should be cooled to the minimum temperature. The input voltage to the regulator should be maintained at 0.6V above the output to keep internal power dissipation and die heating to a minimum. Worst-case occurs just after input power is applied and before the die has had a chance to heat up. Once the minimum value of capacitance has been found for the brand and type of electrolytic in question, the value should be doubled for actual use to account for production variations both in the capacitor and the regulator. (All the values in this section and the remainder of the data sheet were determined in this fashion.)

LM2931 micro SMD Light Sensitivity

When the LM2931 micro SMD package is exposed to bright sunlight, normal office fluorescent light, and other LED's, it operates within the guaranteed limits specified in the electrical characteristic table.

Definition of Terms

Dropout Voltage: The input-output voltage differential at which the circuit ceases to regulate against further reduction in input voltage. Measured when the output voltage has dropped 100 mV from the nominal value obtained at 14V input, dropout voltage is dependent upon load current and junction temperature.

Input Voltage: The DC voltage applied to the input terminals with respect to ground.

Input-Output Differential: The voltage difference between the unregulated input voltage and the regulated output voltage for which the regulator will operate.

Line Regulation: The change in output voltage for a change in the input voltage. The measurement is made under conditions of low dissipation or by using pulse techniques such that the average chip temperature is not significantly affected.

Load Regulation: The change in output voltage for a change in load current at constant chip temperature.

Long Term Stability: Output voltage stability under accelerated life-test conditions after 1000 hours with maximum rated voltage and junction temperature.

Output Noise Voltage: The rms AC voltage at the output, with constant load and no input ripple, measured over a specified frequency range.

Quiescent Current: That part of the positive input current that does not contribute to the positive load current. The regulator ground lead current.

Ripple Rejection: The ratio of the peak-to-peak input ripple voltage to the peak-to-peak output ripple voltage at a specified frequency.

Temperature Stability of V_o : The percentage change in output voltage for a thermal variation from room temperature to either temperature extreme.

Physical Dimensions inches (millimeters) unless otherwise noted

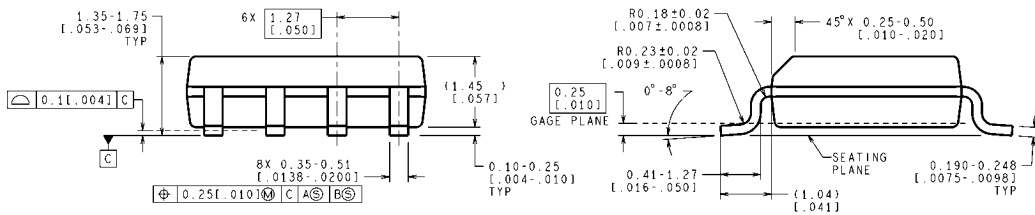
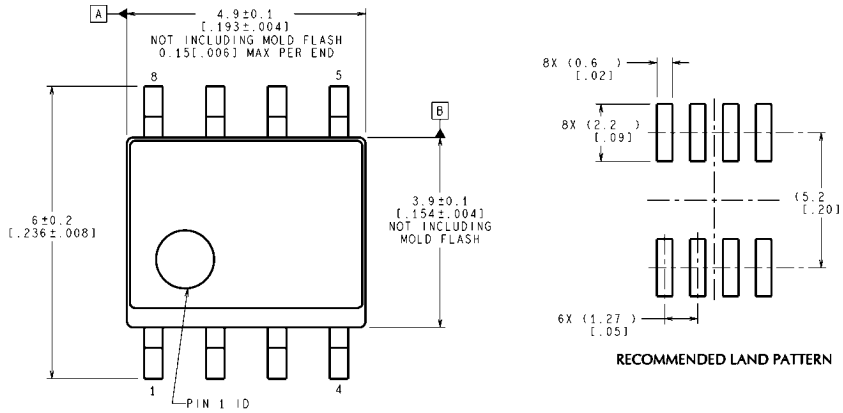

CONTROLLING DIMENSION IS MILLIMETER
VALUES IN [] ARE INCHES
DIMENSIONS IN () FOR REFERENCE ONLY

M08A (Rev K)

8-Lead Surface Mount Package (M)
NS Package Number M08A

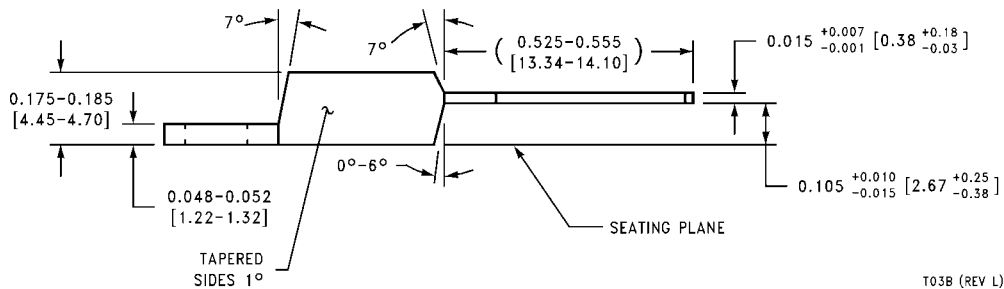
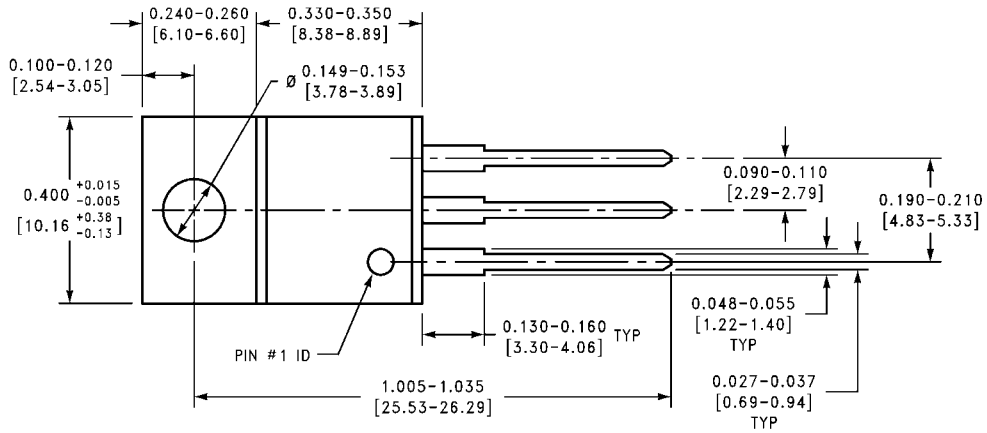

3-Lead TO-220 Plastic Package (T)
NS Package Number T03B

T03B (REV L)

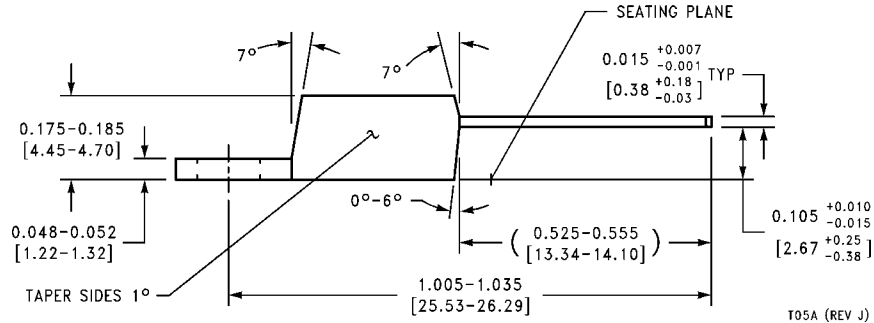
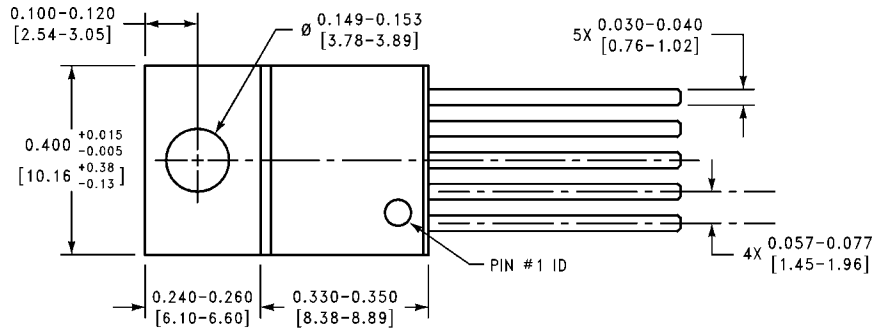

5-Lead TO-220 Power Package (T)
NS Package Number T05A

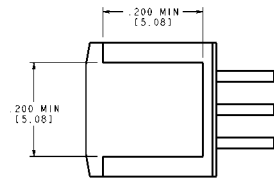
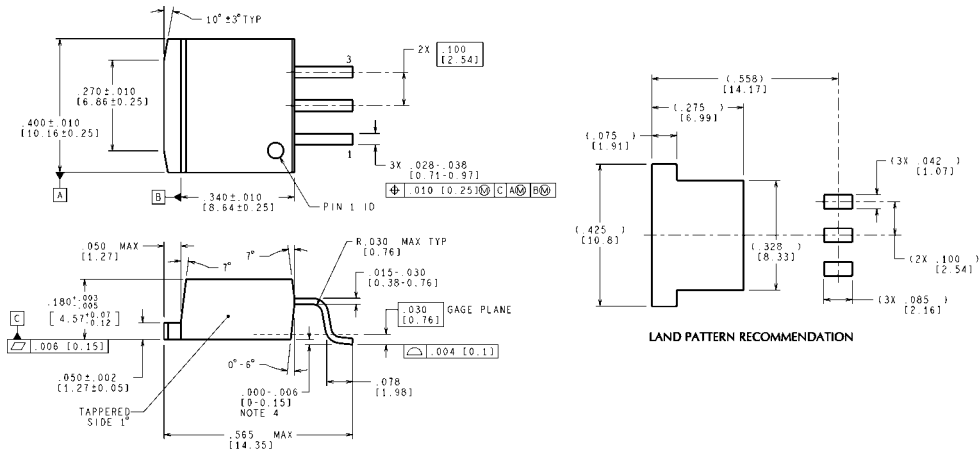

CONTROLLING DIMENSION IS INCH
VALUES IN [] ARE MILLIMETERS
DIMENSIONS IN [] FOR REFERENCE ONLY

3-Lead TO-263 Surface Mount Package
NS Package Number TS3B

TS3B (Rev F)

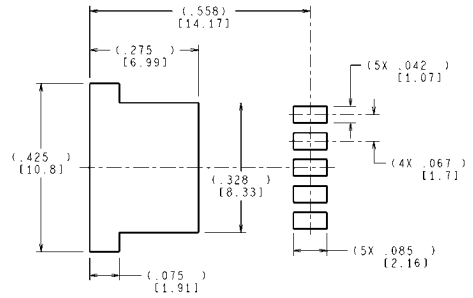
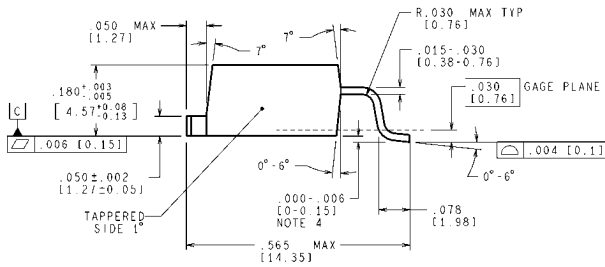
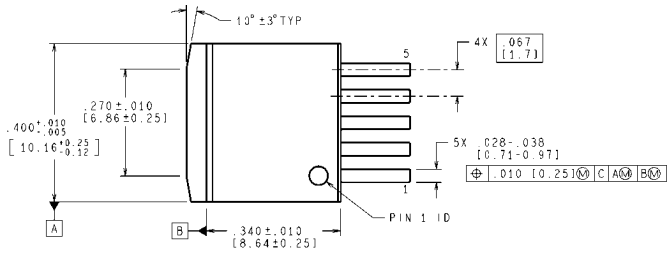

LAND PATTERN RECOMMENDATION

CONTROLLING DIMENSION IS INCH
VALUES IN [] ARE MILLIMETERS
DIMENSIONS IN () FOR REFERENCE ONLY

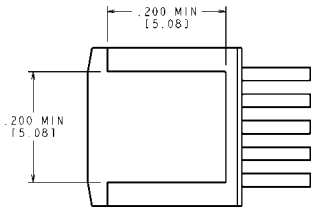

5-Lead TO-263 Surface Mount Package
NS Package Number TS5B

TSSB (Rev D)

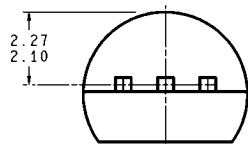
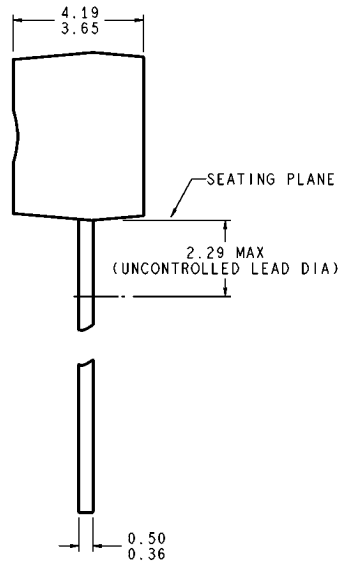
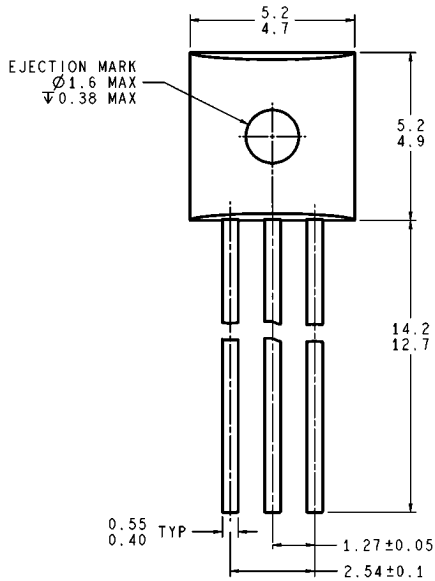

DIMENSIONS ARE IN MILLIMETERS

3-Lead TO-92 Plastic Package (Z)
NS Package Number Z03A

Z03A (Rev G)

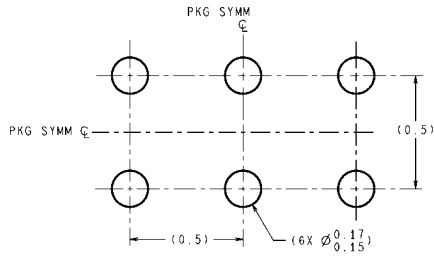

DIMENSIONS ARE IN MILLIMETERS
DIMENSIONS IN () FOR REFERENCE ONLY

LAND PATTERN RECOMMENDATION

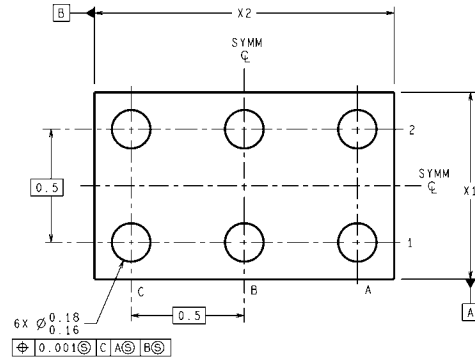
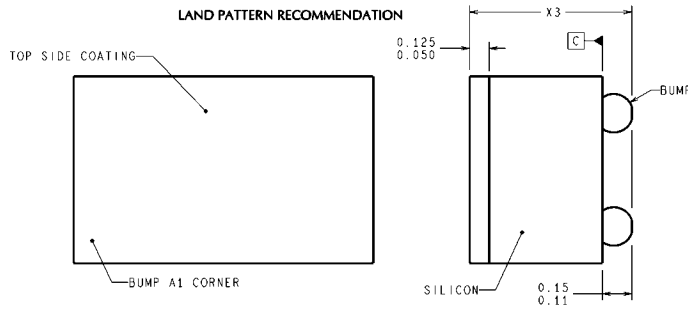

BPA06XXX (Rev D)

NOTE: UNLESS OTHERWISE SPECIFIED.

1. EPOXY COATING.
2. 63Sn/37Pb EUTECTIC BUMP.
3. RECOMMEND NON-SOLDER MASK DEFINED LANDING PAD.
4. PIN A1 IS ESTABLISHED BY LOWER LEFT CORNER WITH RESPECT TO TEST ORIENTATION PINS ARE NUMBERED COUNTERCLOCKWISE.
5. XXX IN DRAWING NUMBER REPRESENTS PACKAGE SIZE VARIATION WHERE X₁ IS PACKAGE WIDTH, X₂ IS PACKAGE LENGTH AND X₃ IS PACKAGE HEIGHT.
6. REFERENCE JEDEC REGISTRATION MO-211, VARIATION BC.

6-Bump micro SMD
NS Package Number BPA06HTB
X₁ = 0.955 X₂ = 1.717 X₃ = 0.850

Notes

National does not assume any responsibility for use of any circuitry described, no circuit patent licenses are implied and National reserves the right at any time without notice to change said circuitry and specifications.

For the most current product information visit us at www.national.com.

LIFE SUPPORT POLICY

NATIONAL'S PRODUCTS ARE NOT AUTHORIZED FOR USE AS CRITICAL COMPONENTS IN LIFE SUPPORT DEVICES OR SYSTEMS WITHOUT THE EXPRESS WRITTEN APPROVAL OF THE PRESIDENT AND GENERAL COUNSEL OF NATIONAL SEMICONDUCTOR CORPORATION. As used herein:

- | | |
|--|---|
| <p>1. Life support devices or systems are devices or systems which, (a) are intended for surgical implant into the body, or (b) support or sustain life, and whose failure to perform when properly used in accordance with instructions for use provided in the labeling, can be reasonably expected to result in a significant injury to the user.</p> | <p>2. A critical component is any component of a life support device or system whose failure to perform can be reasonably expected to cause the failure of the life support device or system, or to affect its safety or effectiveness.</p> |
|--|---|

BANNED SUBSTANCE COMPLIANCE

National Semiconductor certifies that the products and packing materials meet the provisions of the Customer Products Stewardship Specification (CSP-9-111C2) and the Banned Substances and Materials of Interest Specification (CSP-9-111S2) and contain no "Banned Substances" as defined in CSP-9-111S2.

Leadfree products are RoHS compliant.



National Semiconductor Americas Customer Support Center
 Email: new.feedback@nsc.com
 Tel: 1-800-272-9959

National Semiconductor Europe Customer Support Center
 Fax: +49 (0) 180-530-85-86
 Email: europe.support@nsc.com
 Deutsch Tel: +49 (0) 69 9508 6208
 English Tel: +49 (0) 870 24 0 2171
 Français Tel: +33 (0) 1 41 91 8790

National Semiconductor Asia Pacific Customer Support Center
 Email: ap.support@nsc.com

National Semiconductor Japan Customer Support Center
 Fax: 81-3-5639-7507
 Email: jpn.feedback@nsc.com
 Tel: 81-3-5639-7560