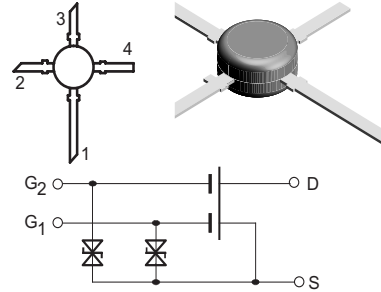


N-Channel Dual Gate MOS-Fieldeffect Tetrode, Depletion Mode

Features

- Integrated gate protection diodes
- High cross modulation performance
- Low noise figure
- High AGC-range
- Low feedback capacitance
- Low input capacitance



Applications

Input- and mixer stages especially UHF-tuners.



Electrostatic sensitive device.
Observe precautions for handling.

13625

Mechanical Data

Case: TO-50 Plastic case

Weight: approx. 124 mg

Marking: BF966S

Pinning:

1 = Drain, 2 = Source,

3 = Gate 1, 4 = Gate 2

Parts Table

Part	Ordering Ccode	Marking	Package
BF966S	BF966SA or BF966SB	BF966S	TO50
BF966SA	BF966SA	BF966S	TO50
BF966SB	BF966SB	BF966S	TO50

Absolute Maximum Ratings

$T_{amb} = 25\text{ }^{\circ}\text{C}$, unless otherwise specified

Parameter	Test condition	Symbol	Value	Unit
Drain - source voltage		V_{DS}	20	V
Drain current		I_D	30	mA
Gate 1/Gate 2 - source peak current		$\pm I_{G1/G2SM}$	10	mA
Total power dissipation	$T_{amb} \leq 60\text{ }^{\circ}\text{C}$	P_{tot}	200	mW
Channel temperature		T_{Ch}	150	$^{\circ}\text{C}$
Storage temperature range		T_{stg}	- 55 to + 150	$^{\circ}\text{C}$

Maximum Thermal Resistance

Parameter	Test condition	Symbol	Value	Unit
Channel ambient	¹⁾	R_{thChA}	450	K/W

¹⁾ on glass fibre printed board (40 x 25 x 1.5) mm³ plated with 35 μm Cu

Electrical DC Characteristics

T_{amb} = 25 °C, unless otherwise specified

Parameter	Test condition	Part	Symbol	Min	Typ.	Max	Unit
Drain - source breakdown voltage	I _D = 10 μA, -V _{G1S} = -V _{G2S} = 4 V		V _{(BR)DS}	20			V
Gate 1 - source breakdown voltage	± I _{G1S} = 10 mA, V _{G2S} = V _{DS} = 0		± V _{(BR)G1SS}	8		14	V
Gate 2 - source breakdown voltage	± I _{G2S} = 10 mA, V _{G1S} = V _{DS} = 0		± V _{(BR)G2SS}	8		14	V
Gate 1 - source leakage current	± V _{G1S} = 5 V, V _{G2S} = V _{DS} = 0		± I _{G1SS}			50	nA
Gate 2 - source leakage current	± V _{G2S} = 5 V, V _{G1S} = V _{DS} = 0		± I _{G2SS}			50	nA
Drain current	V _{DS} = 15 V, V _{G1S} = 0, V _{G2S} = 4 V	BF966S	I _{DSS}	4		18	mA
		BF966SA	I _{DSS}	4		10.5	mA
		BF966SB	I _{DSS}	9.5		18	mA
Gate 1 - source cut-off voltage	V _{DS} = 15 V, V _{G2S} = 4 V, I _D = 20 μA		-V _{G1S(OFF)}			2.5	V
Gate 2 - source cut-off voltage	V _{DS} = 15 V, V _{G1S} = 0, I _D = 20 μA		-V _{G2S(OFF)}			2.0	V

Electrical AC Characteristics

T_{amb} = 25 °C, unless otherwise specified

V_{DS} = 15 V, I_D = 10 mA, V_{G2S} = 4 V, f = 1 MHz

Parameter	Test condition	Symbol	Min	Typ.	Max	Unit
Forward transadmittance		y _{21s}	15	18.5		mS
Gate 1 input capacitance		C _{issg1}		2.2	2.6	pF
Gate 2 input capacitance	V _{G1S} = 0, V _{G2S} = 4 V	C _{issg2}		1.1		pF
Feedback capacitance		C _{rss}		25	35	fF
Output capacitance		C _{oss}		0.8	1.2	pF
Power gain	G _S = 2 mS, G _L = 0.5 mS, f = 200 MHz	G _{ps}		25		dB
	G _S = 3.3 mS, G _L = 1 mS, f = 800 MHz	G _{ps}		18		dB
AGC range	V _{G2S} = 4 to -2 V, f = 800 MHz	ΔG _{ps}	40			dB
Noise figure	G _S = 2 mS, G _L = 0.5 mS, f = 200 MHz	F		1.0		dB
	G _S = 3.3 mS, G _L = 1 mS, f = 800 MHz	F		1.8		dB

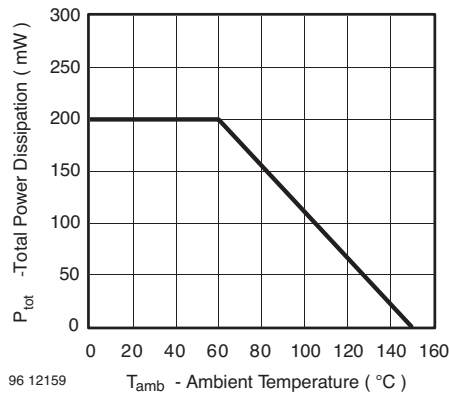
Typical Characteristics ($T_{amb} = 25\text{ }^{\circ}\text{C}$ unless otherwise specified)


Figure 1. Total Power Dissipation vs. Ambient Temperature

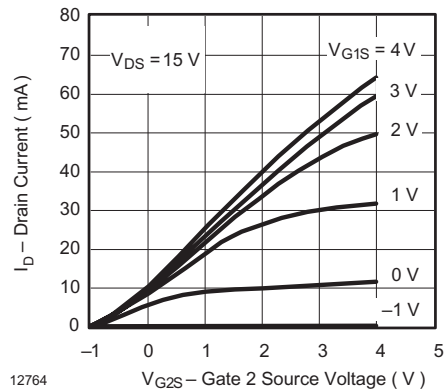


Figure 4. Drain Current vs. Gate 2 Source Voltage

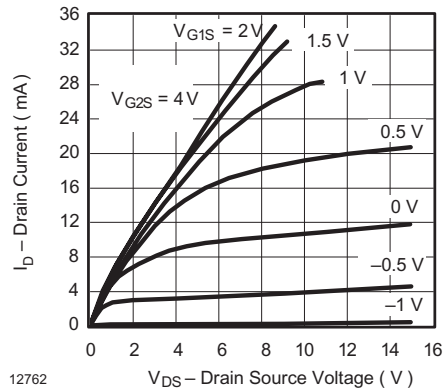


Figure 2. Drain Current vs. Drain Source Voltage

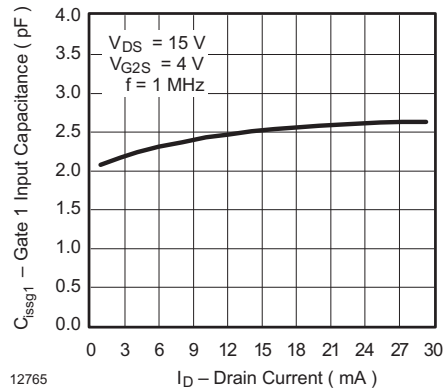


Figure 5. Gate 1 Input Capacitance vs. Drain Current

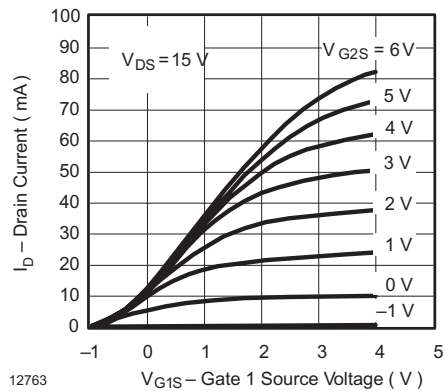


Figure 3. Drain Current vs. Gate 1 Source Voltage

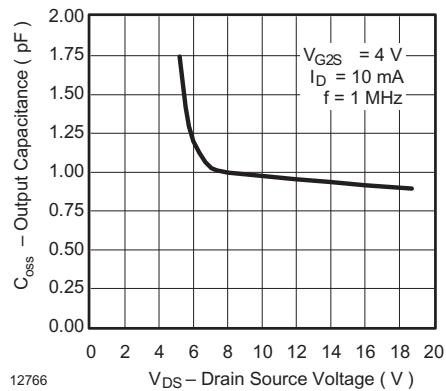


Figure 6. Output Capacitance vs. Drain Source Voltage

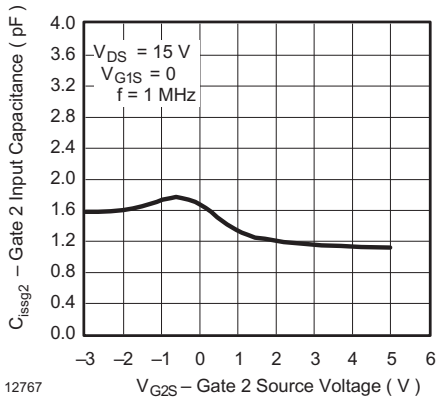


Figure 7. Gate 2 Input Capacitance vs. Gate 2 Source Voltage

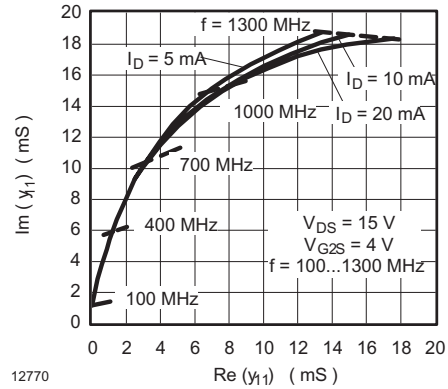


Figure 10. Short Circuit Input Admittance

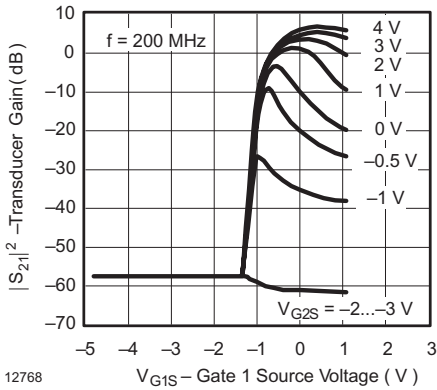


Figure 8. Transducer Gain vs. Gate 1 Source Voltage

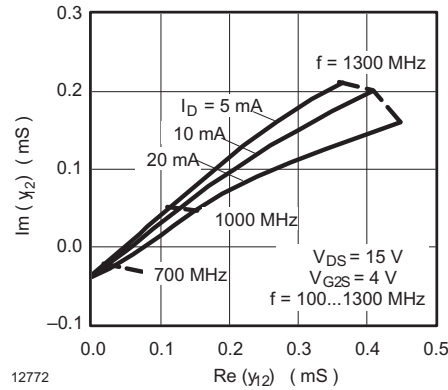


Figure 11. Short Circuit Reverse Transfer Admittance

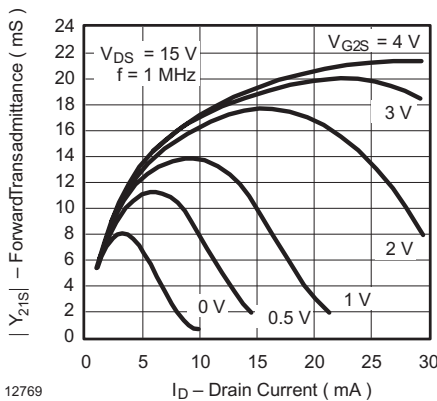


Figure 9. Forward Transadmittance vs. Drain Current

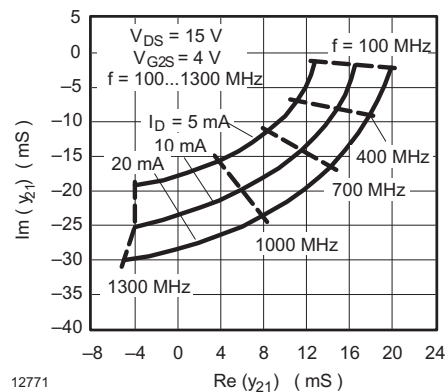


Figure 12. Short Circuit Forward Transfer Admittance

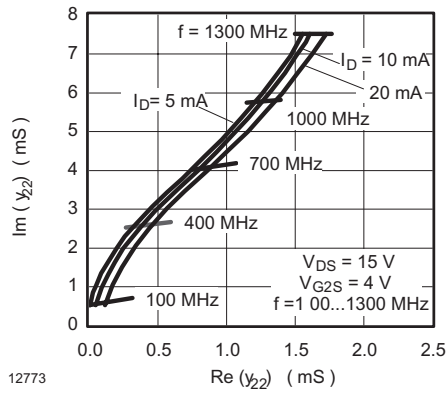
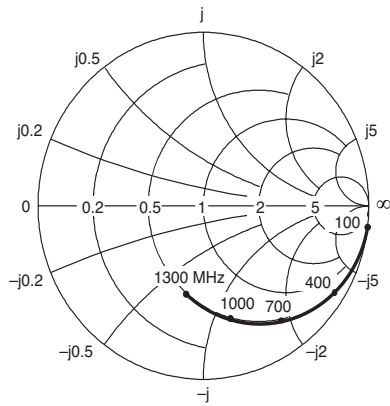


Figure 13. Short Circuit Output Admittance

$V_{DS} = 15\text{ V}$, $I_D = 5\text{ to }20\text{ mA}$, $V_{G2S} = 4\text{ V}$, $Z_0 = 50\ \Omega$

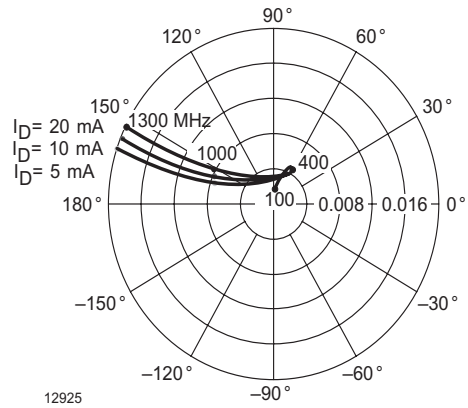
S_{11}



12924

Figure 14. Input Reflection Coefficient

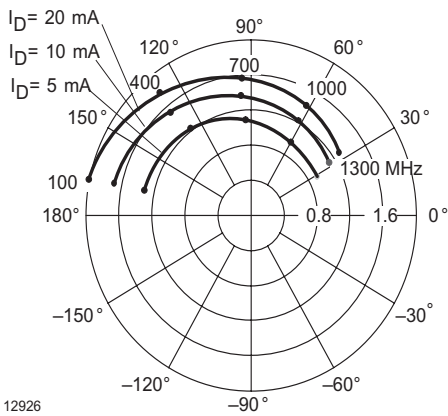
S_{12}



12925

Figure 16. Reverse Transmission Coefficient

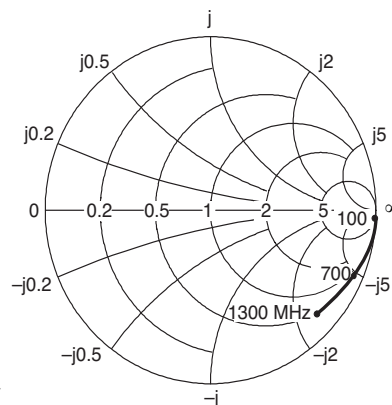
S_{21}



12926

Figure 15. Forward Transmission Coefficient

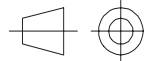
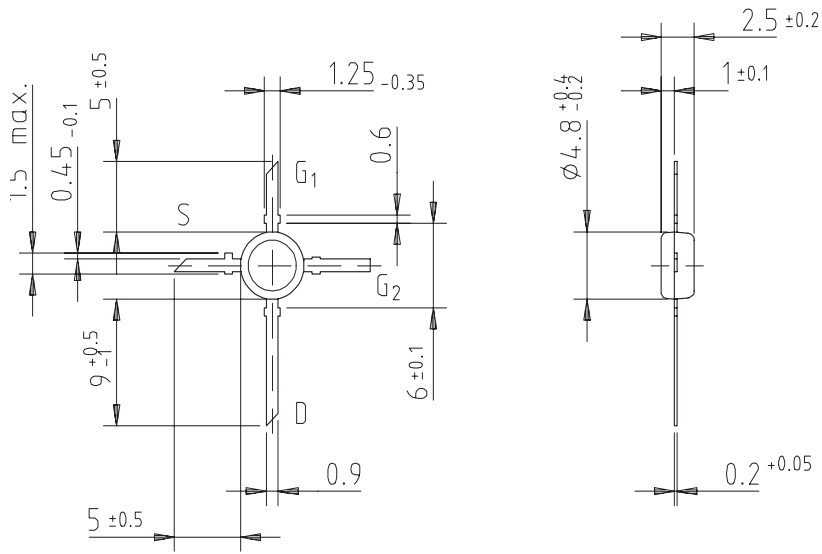
S_{22}



12927

Figure 17. Output Reflection Coefficient

Package Dimensions in mm



96 12242

technical drawings
according to DIN
specifications

Ozone Depleting Substances Policy Statement

It is the policy of Vishay Semiconductor GmbH to

1. Meet all present and future national and international statutory requirements.
2. Regularly and continuously improve the performance of our products, processes, distribution and operating systems with respect to their impact on the health and safety of our employees and the public, as well as their impact on the environment.

It is particular concern to control or eliminate releases of those substances into the atmosphere which are known as ozone depleting substances (ODSs).

The Montreal Protocol (1987) and its London Amendments (1990) intend to severely restrict the use of ODSs and forbid their use within the next ten years. Various national and international initiatives are pressing for an earlier ban on these substances.

Vishay Semiconductor GmbH has been able to use its policy of continuous improvements to eliminate the use of ODSs listed in the following documents.

1. Annex A, B and list of transitional substances of the Montreal Protocol and the London Amendments respectively
2. Class I and II ozone depleting substances in the Clean Air Act Amendments of 1990 by the Environmental Protection Agency (EPA) in the USA
3. Council Decision 88/540/EEC and 91/690/EEC Annex A, B and C (transitional substances) respectively.

Vishay Semiconductor GmbH can certify that our semiconductors are not manufactured with ozone depleting substances and do not contain such substances.

We reserve the right to make changes to improve technical design
and may do so without further notice.

Parameters can vary in different applications. All operating parameters must be validated for each customer application by the customer. Should the buyer use Vishay Semiconductors products for any unintended or unauthorized application, the buyer shall indemnify Vishay Semiconductors against all claims, costs, damages, and expenses, arising out of, directly or indirectly, any claim of personal damage, injury or death associated with such unintended or unauthorized use.

Vishay Semiconductor GmbH, P.O.B. 3535, D-74025 Heilbronn, Germany
Telephone: 49 (0)7131 67 2831, Fax number: 49 (0)7131 67 2423