

REPETITIVE AVALANCHE AND dv/dt RATED*

HEXFET® TRANSISTORS

IRF720

IRF721

IRF722

IRF723

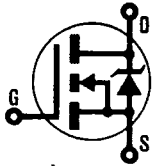

N-CHANNEL



400 Volt, 1.8 Ohm HEXFET TO-220AB Plastic Package

The HEXFET® technology is the key to International Rectifier's advanced line of power MOSFET transistors. The efficient geometry and unique processing of this latest "State of the Art" design achieves: very low on-state resistance combined with high transconductance; superior reverse energy and diode recovery dv/dt capability.

The HEXFET transistors also feature all of the well established advantages of MOSFETs such as voltage control, very fast switching, ease of paralleling and temperature stability of the electrical parameters.

They are well suited for applications such as switching power supplies, motor controls, inverters, choppers, audio amplifiers and high energy pulse circuits.

Product Summary

Part Number	BVDSS	R _{DS(on)}	I _D
IRF720	400V	1.8Ω	3.3A
IRF721	350V	1.8Ω	3.3A
IRF722	400V	2.5Ω	2.8A
IRF723	350V	2.5Ω	2.8A

FEATURES:

- Repetitive Avalanche Ratings
- Dynamic dv/dt Rating
- Simple Drive Requirements
- Ease of Paralleling

CASE STYLE AND DIMENSIONS

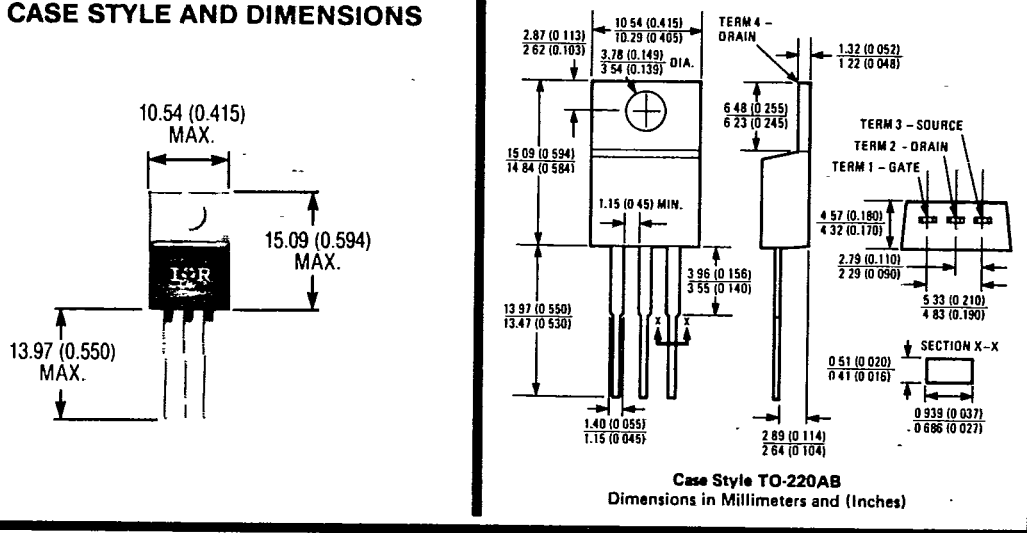

*This data sheet applies to product with batch codes that begin with a digit, ie. 2A3B
C-277

Absolute Maximum Ratings

Parameter	IRF720, IRF721	IRF722, IRF723	Units
$I_D @ T_C = 25^\circ\text{C}$ Continuous Drain Current	3.3	2.8	A
$I_D @ T_C = 100^\circ\text{C}$ Continuous Drain Current	2.1	1.8	A
I_{DM} Pulsed Drain Current $\text{\textcircled{1}}$	13	11	A
$P_D @ T_C = 25^\circ\text{C}$ Max. Power Dissipation	50		W
Linear Derating Factor	0.40		W/K $\text{\textcircled{2}}$
V_{GS} Gate-to-Source Voltage	± 20		V
E_{AS} Single Pulse Avalanche Energy $\text{\textcircled{2}}$	190 (See Fig. 14)		mJ
I_{AR} Avalanche Current $\text{\textcircled{1}}$ (Repetitive or Non-Repetitive)	3.3 (See E_{AR})		A
E_{AR} Repetitive Avalanche Energy $\text{\textcircled{1}}$	5.0 (See I_{AR})		mJ
dv/dt Peak Diode Recovery dv/dt $\text{\textcircled{3}}$	4.0 (See Fig. 17)		V/ns
T_J Operating Junction T_{STG} Storage Temperature Range	-55 to 150		$^\circ\text{C}$
Lead Temperature	300 (0.063 in. (1.6mm) from case for 10s)		$^\circ\text{C}$

Electrical Characteristics @ $T_J = 25^\circ\text{C}$ (Unless Otherwise Specified)

Parameter	Type	Min.	Typ.	Max.	Units	Test Conditions
BV_{DSS} Drain-to-Source Breakdown Voltage	IRF720 IRF722	400	—	—	V	$V_{GS} = 0V, I_D = 250 \mu\text{A}$
	IRF721 IRF723	350	—	—		
$R_{DS(on)}$ Static Drain-to-Source On-State Resistance $\text{\textcircled{4}}$	IRF720 IRF721	—	1.6	1.8	Ω	$V_{GS} = 10V, I_D = 1.8A$
	IRF722 IRF723	—	1.8	2.5		
$I_{D(on)}$ On-State Drain Current $\text{\textcircled{4}}$	IRF720 IRF721	3.3	—	—	A	$V_{DS} > I_{D(on)} \times R_{DS(on)}$ Max. $V_{GS} = 10V$
	IRF722 IRF723	2.8	—	—		
$V_{GS(th)}$ Gate Threshold Voltage	ALL	2.0	—	4.0	V	$V_{DS} = V_{GS}, I_D = 250 \mu\text{A}$
g_{fs} Forward Transconductance $\text{\textcircled{4}}$	ALL	1.8	2.7	—	S (f)	$I_{DS} = 1.8A, V_{DS} \geq 50V$
I_{DSS} Zero Gate Voltage Drain Current	ALL	—	—	250	μA	$V_{DS} = \text{Max. Rating}, V_{GS} = 0V$ $V_{DS} = 0.8 \times \text{Max. Rating}$ $V_{GS} = 0V, T_J = 125^\circ\text{C}$
		—	—	1000		
I_{GSS} Gate-to-Source Leakage Forward	ALL	—	—	500	nA	$V_{GS} = 20V$
I_{GSS} Gate-to-Source Leakage Reverse	ALL	—	—	-500	nA	$V_{GS} = -20V$
Q_g Total Gate Charge	ALL	—	13	20	nC	$V_{GS} = 10V, I_D = 3.3A$ $V_{DS} = 0.8 \times \text{Max. Rating}$ See Fig. 16 (Independent of operating temperature)
Q_{gs} Gate-to-Source Charge	ALL	—	2.2	3.3	nC	
Q_{gd} Gate-to-Drain ("Miller") Charge	ALL	—	7.2	11	nC	
$t_{d(on)}$ Turn-On Delay Time	ALL	—	10	15	ns	$V_{DD} = 200V, I_D \approx 3.3A, R_G = 18\Omega$ $R_D = 56\Omega$ See Fig. 15 (Independent of operating temperature)
t_r Rise Time	ALL	—	14	21	ns	
$t_{d(off)}$ Turn-Off Delay Time	ALL	—	30	45	ns	
t_f Fall Time	ALL	—	13	20	ns	
L_D Internal Drain Inductance	ALL	—	4.5	—	nH	Measured from the drain lead, 6mm (0.25 in.) from package to center of die. Modified MOSFET symbol showing the internal inductances. 
L_S Internal Source Inductance	ALL	—	7.5	—	nH	
C_{iss} Input Capacitance	ALL	—	350	—	pF	$V_{GS} = 0V, V_{DS} = 25V$ $f = 1.0 \text{ MHz}$ See Fig. 10
C_{oss} Output Capacitance	ALL	—	64	—	pF	
C_{rss} Reverse Transfer Capacitance	ALL	—	8.1	—	pF	

Source-Drain Diode Ratings and Characteristics

Parameter	Type	Min.	Typ.	Max.	Units	Test Conditions
I_S Continuous Source Current (Body Diode)	ALL	—	—	3.3	A	Modified MOSFET symbol showing the integral Reverse p-n junction rectifier. 
I_{SM} Pulsed Source Current (Body Diode) ①	ALL	—	—	13	A	
V_{SD} Diode Forward Voltage ②	ALL	—	—	1.6	V	$T_J = 25^\circ\text{C}$, $I_S = 3.3\text{A}$, $V_{GS} = 0\text{V}$
t_{rr} Reverse Recovery Time	ALL	120	270	600	ns	$T_J = 25^\circ\text{C}$, $I_F = 3.3\text{A}$, $di/dt = 100\text{ A}/\mu\text{s}$
Q_{RR} Reverse Recovery Charge	ALL	0.64	1.4	3.0	μC	
t_{on} Forward Turn-On Time	ALL	Intrinsic turn-on time is negligible. Turn-on speed is substantially controlled by $L_S + L_D$.				

Thermal Resistance

R_{thJC} Junction-to-Case	ALL	—	—	2.5	KW ③	
R_{thCS} Case-to-Sink	ALL	—	0.50	—	KW ③	Mounting surface flat, smooth, and greased
R_{thJA} Junction-to-Ambient	ALL	—	—	80	KW ③	Typical socket mount

Typical SPICE Computer Model Parameters (For More Information See Application Note AN-975)

Device	Level, SPICE MOSFET Model	W (μm), Channel Width	L (μm), Channel Length	Theta (1/V), Mobility Modulation	UO ($\text{CM}^2/\text{V}\cdot\text{S}$), Surface Mobility	VTO (V), Threshold Voltage	R1 (Ω), Drain Resistance	R2 (Ω), Source Resistance	RG (Ω), Gate Resistance
ALL	3	0.279	1.2	0.30	450	4.00	1.4	0.02	1.5

CGSO (pf), Gate-Source Capacitance	CGD (F), Gate-Drain Capacitance	E1 (V), Voltage Dependent Voltage Source	LD (nH), Drain Inductance	LS (nH), Source Inductance	LG (nH), Gate Inductance	IS (A), Diode Saturation Current	RS (Ω), Diode Bulk Resistance
770	C8	$2 + 0.995\text{VDG}$	4.5	7.5	7.5	3.8×10^{-13}	0.026

$C8 = 1500\text{ pf} + 1.8 \times 10^{-22} (V_{GE})^{48}$

- ① Repetitive Rating: Pulse width limited by maximum junction temperature (see figure 5) Refer to current HEXFET reliability report
- ② @ $V_{DD} = 50\text{V}$, Starting $T_J = 25^\circ\text{C}$, $L = 31\text{ mH}$, $R_G = 25\Omega$, Peak $I_L = 3.3\text{A}$.
- ③ $I_{SD} \leq 3.3\text{A}$, $di/dt \leq 65\text{A}/\mu\text{s}$, $V_{DD} \leq BV_{DSS}$, $T_J \leq 150^\circ\text{C}$ Suggested $R_G = 18\Omega$
- ④ Pulse width $\leq 300\ \mu\text{s}$; Duty Cycle $\leq 2\%$
- ⑤ $\text{KW} = \text{°CW}$
 $\text{W/K} = \text{W/°C}$

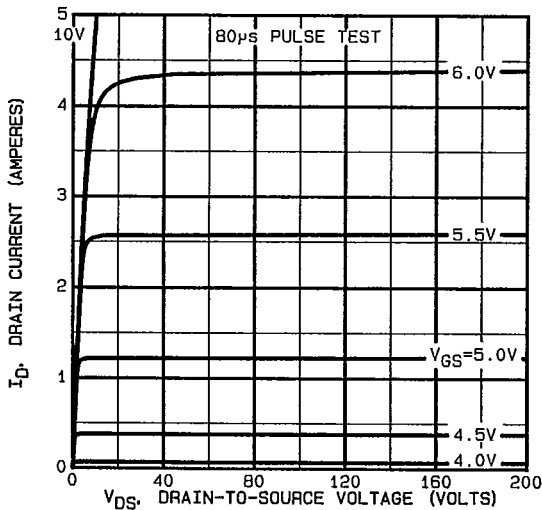

Fig. 1 — Typical Output Characteristics

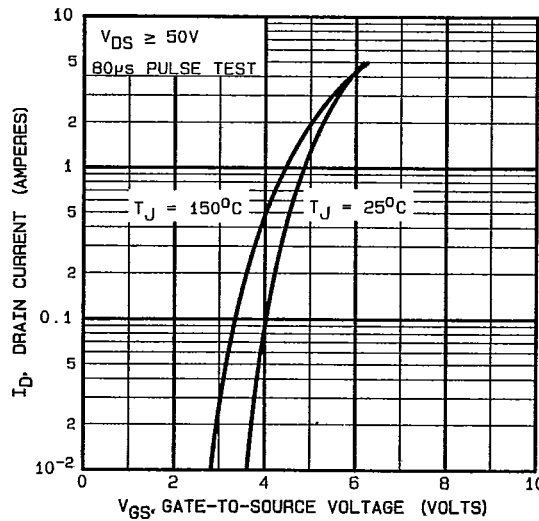

Fig. 2.— Typical Transfer Characteristics

INTERNATIONAL RECTIFIER

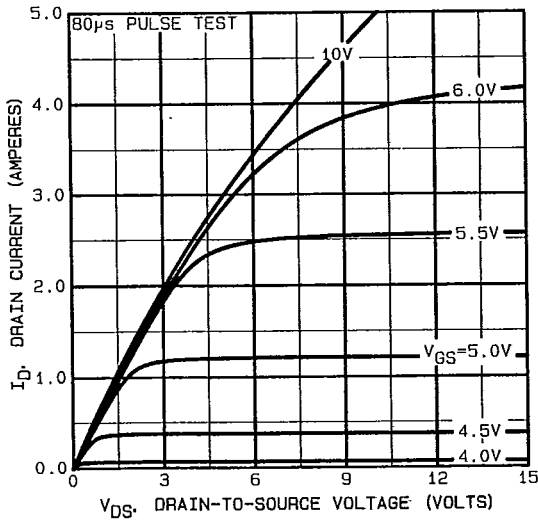

Fig. 3 — Typical Saturation Characteristics

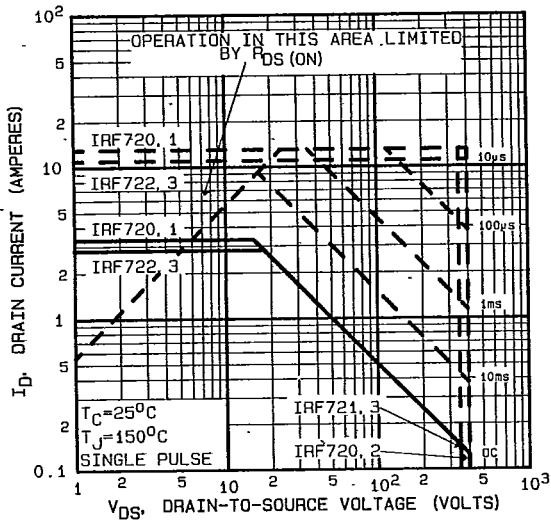

Fig. 4 — Maximum Safe Operating Area

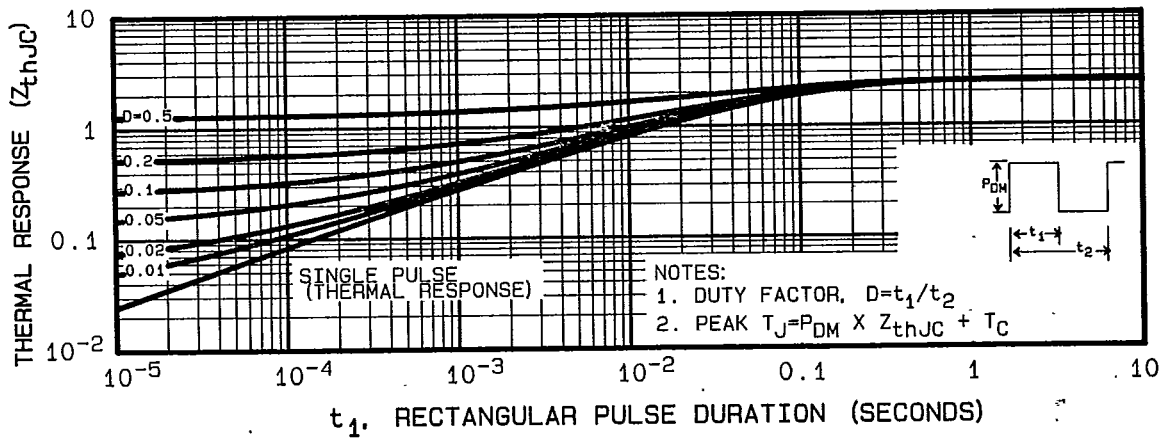

Fig. 5 — Maximum Effective Transient Thermal Impedance, Junction-to-Case Vs. Pulse Duration

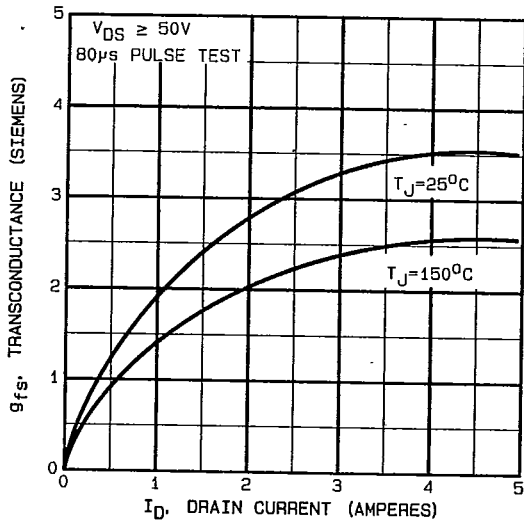

Fig. 6 — Typical Transconductance Vs. Drain Current

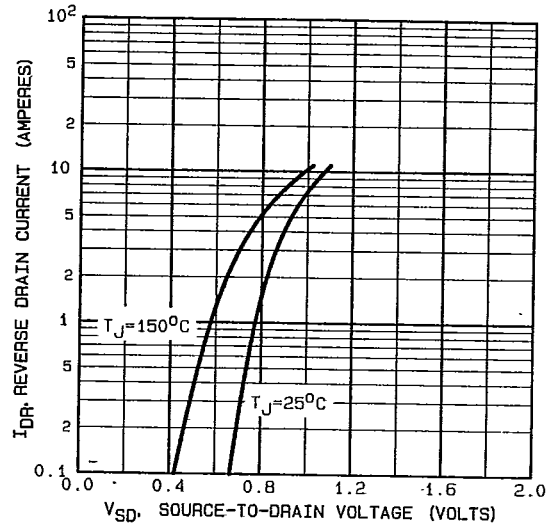

Fig. 7 — Typical Source-Drain Diode Forward Voltage

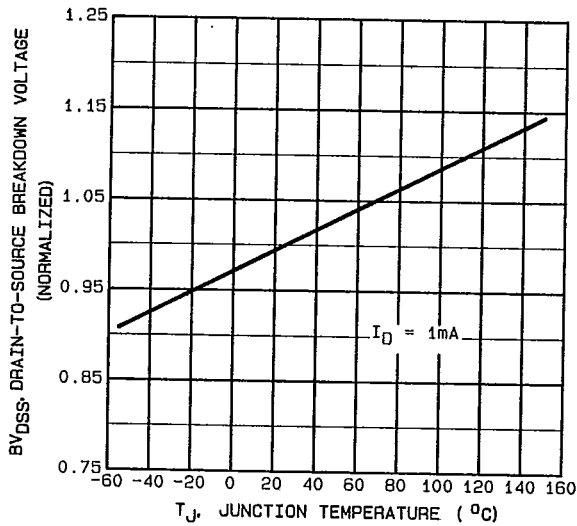

Fig. 8 — Breakdown Voltage Vs. Temperature

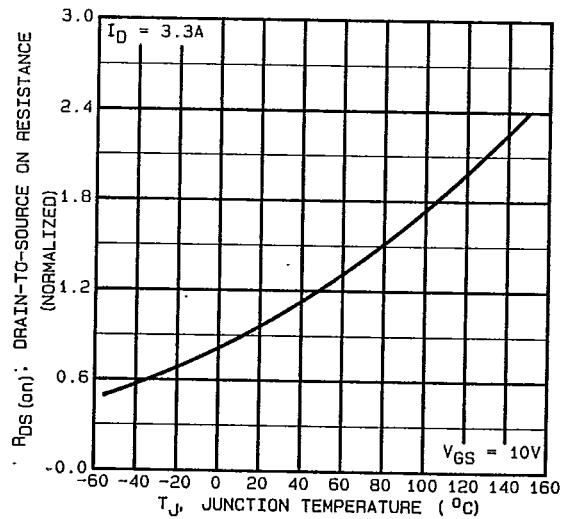

Fig. 9 — Normalized On-Resistance Vs. Temperature

IRF720, IRF721, IRF722, IRF723 Devices

INTERNATIONAL RECTIFIER

T-39-11

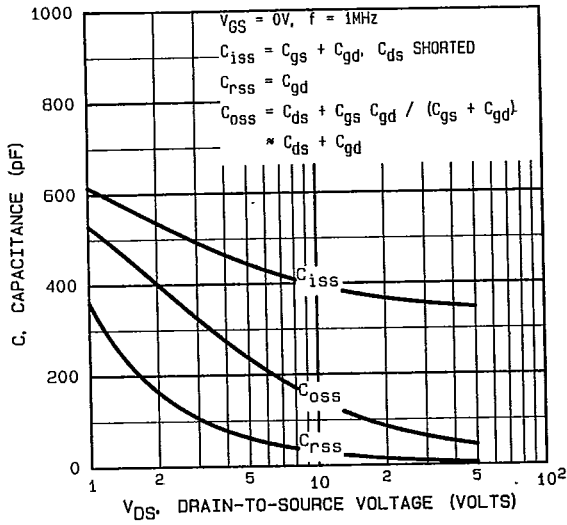

Fig. 10 — Typical Capacitance Vs. Drain-to-Source Voltage

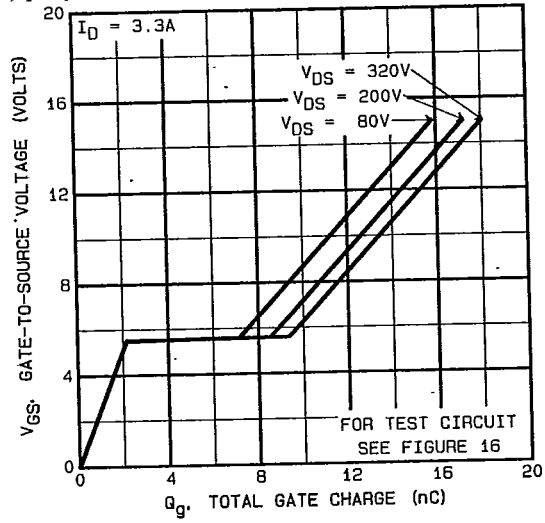

Fig. 11 — Typical Gate Charge Vs. Gate-to-Source Voltage

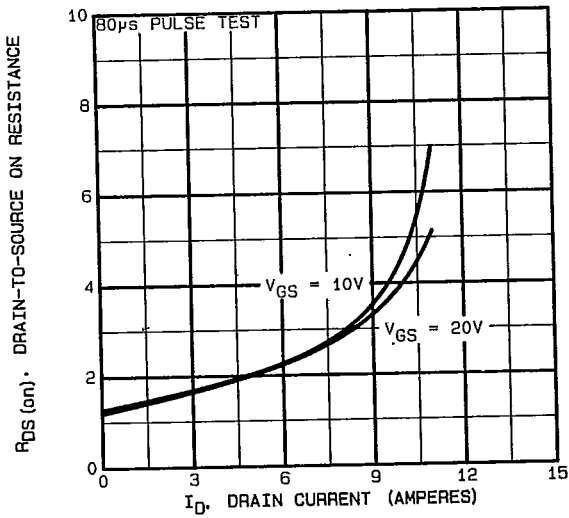

Fig. 12 — Typical On-Resistance Vs. Drain Current

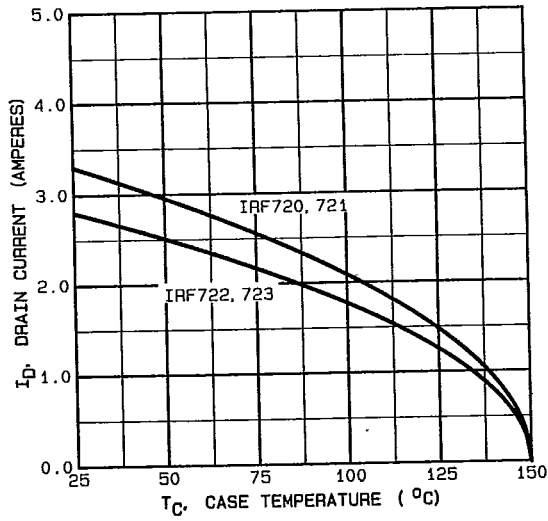

Fig. 13 — Maximum Drain Current Vs. Case Temperature

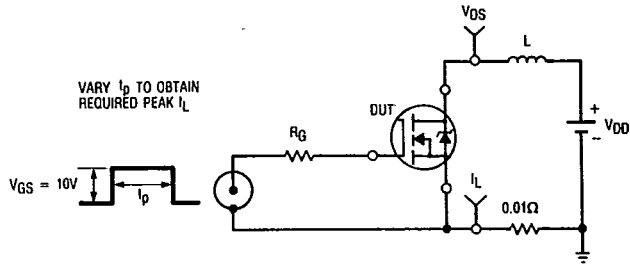

Fig. 14a — Unclamped Inductive Test Circuit

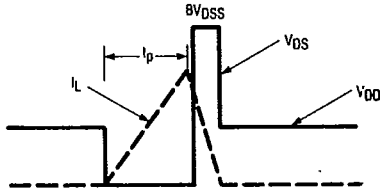

Fig. 14b — Unclamped Inductive Waveforms

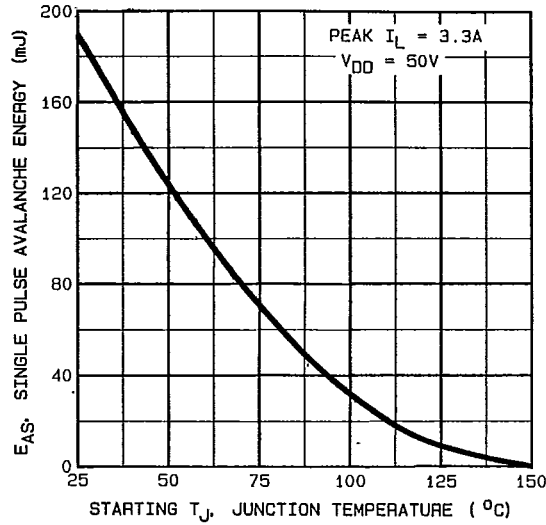

Fig. 14c — Maximum Avalanche Energy Vs. Starting Junction Temperature

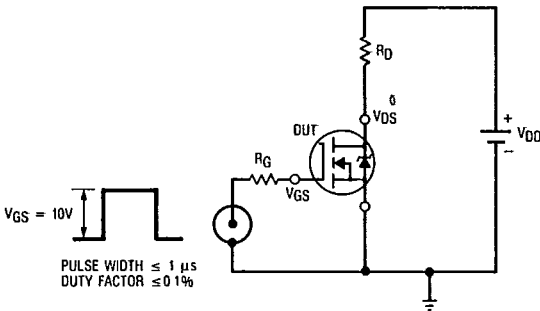

Fig. 15a — Switching Time Test Circuit

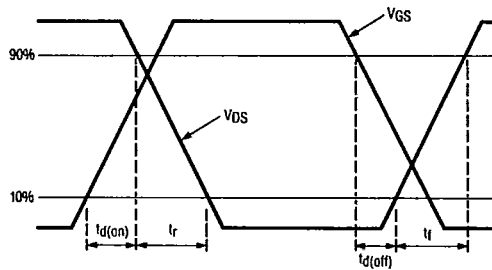

Fig. 15b — Switching Time Waveforms

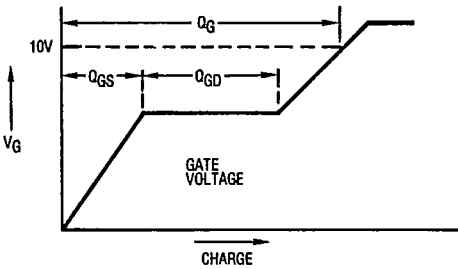

Fig. 16a — Basic Gate Charge Waveform

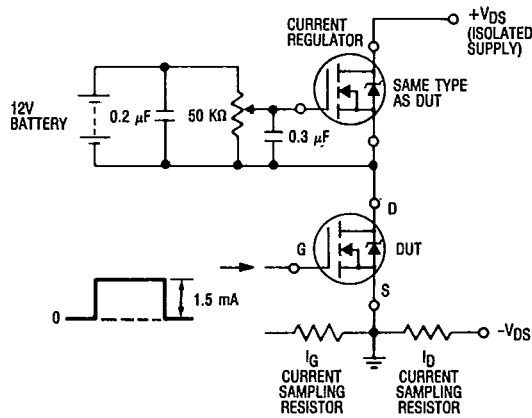

Fig. 16b — Gate Charge Test Circuit

IRF720, IRF721, IRF722, IRF723 Devices

INTERNATIONAL RECTIFIER

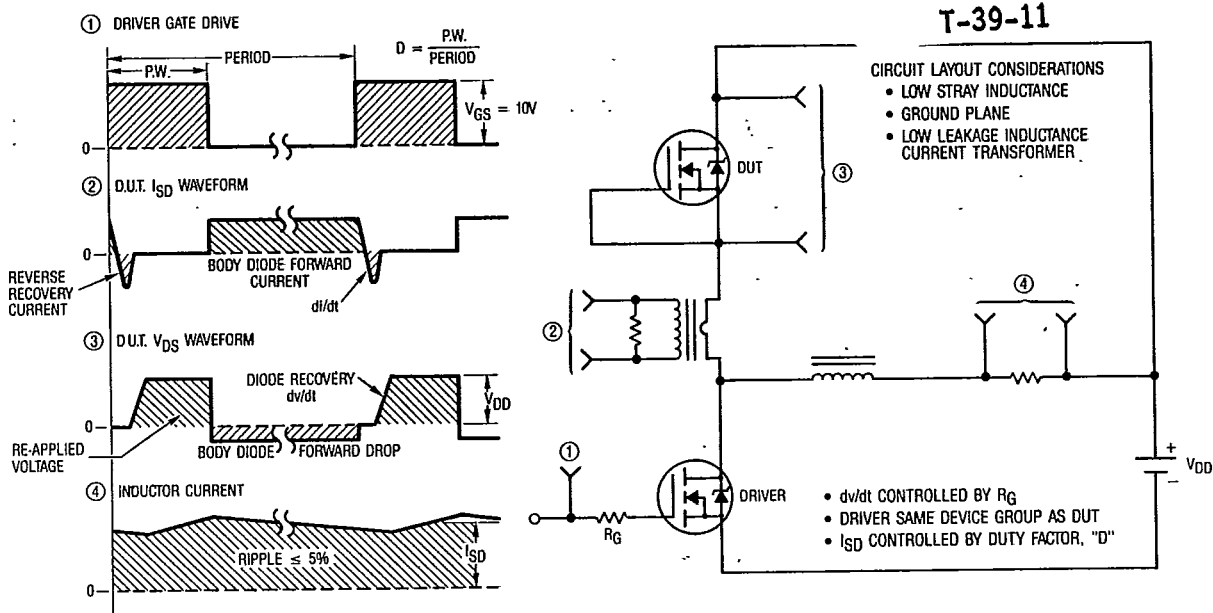
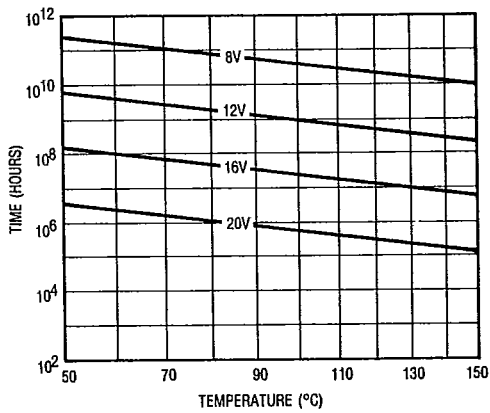
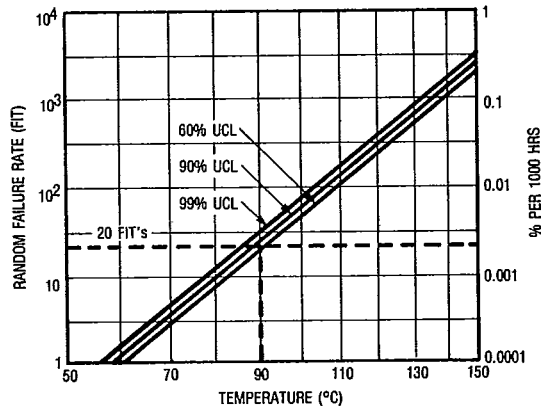

Fig. 17 — Peak Diode Recovery dv/dt Test Circuit



*Fig. 18 — Typical Time to Accumulated 1% Gate Failure



*Fig. 19 — Typical High Temperature Reverse Bias (HTRB) Failure Rate

*The data shown is correct as of April 15, 1987. This information is updated on a quarterly basis; for the latest reliability data, please contact your local IR field office.