

POWER RECTIFIER DIODES

T-Modules

Features

- Electrically isolated base plate
- Types up to 1200 V_{RRM}
- 3500 V_{RMS} isolating voltage
- Simplified mechanical designs, rapid assembly
- High surge capability
- Large creepage distances
- UL E78996 approved 

40 A
 70 A
 85 A
 110 A

Datasheet.Directory

Description

These series of T-modules use standard recovery power rectifier diodes. The semiconductors are electrically isolated from the metal base, allowing common heatsink and compact assembly to be built. Applications include power supplies, battery charges, welders, motor controls and general industrial current rectification.

Major Ratings and Characteristics

Parameters	T40HF	T70HF	T85HF	T110HF	Units	
I _{F(AV)}	40	70	85	110	A	
I _{F(RMS)}	63	110	134	173	°C	
I _{FSM}	50Hz	570	1200	1700	2000	A
	60Hz	600	1250	1800	2100	A
I ² t	50Hz	1630	7100	14500	20500	A ² s
	60Hz	1500	6450	13500	18600	A ² s
I ² /t	16300	70700	148700	204300	A ² /s	
V _{RRM} range	100 to 1200				V	
T _J	-40 to 150				°C	

ELECTRICAL SPECIFICATIONS

Voltage Ratings

Type number	Voltage Code	V _{RRM} , maximum repetitive peak reverse voltage V	V _{RSM} , maximum non-repetitive peak reverse voltage V	I _{RRM} max. T _J = @ 25°C μ A
T40HF.. T70HF.. T85HF.. T110HF..	10	100	150	100
	20	200	300	
	40	400	500	
	60	600	700	
	80	800	900	
	100	1000	1100	
	120	1200	1300	

Forward Conduction

Parameters	T40HF	T70HF	T85HF	T110HF	Units	Conditions
I _{F(AV)} Max. average fwd current @ Case temperature	40	70	85	110	A	180° conduction, half sine wave
	85	85	85	85	°C	
I _{F(RMS)} Max. RMS forward current	63	110	134	173	A	
I _{FSM} Max. peak, one-cycle forward, non-repetitive surge current	570	1200	1700	2000	A	t = 10ms No voltage
	600	1250	1800	2100		t = 8.3ms reapplied
	480	1000	1450	1700		t = 10ms 100% V _{RRM}
	500	1050	1500	1780		t = 8.3ms reapplied
I ² t Maximum I ² t for fusing	1630	7100	14500	20500	A ² s	t = 10ms No voltage
	1500	6450	13500	18600		t = 8.3ms reapplied
	1150	5000	10500	14500		t = 10ms 100% V _{RRM}
	1050	4570	9600	13200		t = 8.3ms reapplied
I ² √t Maximum I ² √t for fusing	16300	70700	148700	204300	A ² √s	t = 0.1 to 10ms, no voltage reapplied
V _{F(TO)1} Low level value of threshold voltage	0.66	0.76	0.68	0.68	V	(16.7% × π × I _{F(AV)}) < I < π × I _{F(AV)} , @ T _J max.
V _{F(TO)2} High level value of threshold voltage	0.84	0.95	0.90	0.86	V	(I > π × I _{F(AV)}), @ T _J max.
r _{f1} Low level value of forward slope resistance	4.3	2.4	1.76	1.56	mΩ	(16.7% × π × I _{F(AV)}) < I < π × I _{F(AV)} , @ T _J max.
r _{f2} High level value of forward slope resistance	3.1	1.7	1.08	1.12	mΩ	(I > π × I _{F(AV)}), @ T _J max.
V _{FM} Max. forward voltage drop	1.30	1.35	1.27	1.35	V	I _{FM} = π × I _{F(AV)} , T _J = 25°C, tp = 400 μs square pulse Av. power = V _{F(TO)} × I _{F(AV)} + r _f × (I _{F(RMS)}) ²

Blocking

Parameters	T40HF	T70HF	T85HF	T110HF	Units	Conditions
I _{RRM} Max. peak reverse leakage current	15	15	20	20	mA	T _J = 150°C
V _{INS} RMS isolation voltage	3500	3500	3500	3500	V	50Hz, circuit to base, all terminals shorted T _J = 25°C, t = 1s

ΔR Conduction (per Junction)

(The following table shows the increment of thermal resistance R_{thJC} when devices operate at different conduction angles than DC)

Devices	Sinusoidal conduction @ T_J max.					Rectangular conduction @ T_J max.					Units
	180°	120°	90°	60°	30°	180°	120°	90°	60°	30°	
T40HF	0.12	0.14	0.18	0.27	0.46	0.09	0.15	0.20	0.28	0.46	K/W
T70HF	0.09	0.11	0.14	0.20	0.35	0.07	0.11	0.15	0.21	0.35	
T85HF	0.08	0.09	0.12	0.18	0.31	0.06	0.10	0.13	0.19	0.31	
T110HF	0.05	0.07	0.09	0.14	0.23	0.05	0.08	0.10	0.15	0.24	

Thermal and Mechanical Specifications

Parameters	T40HF	T70HF	T85HF	T110HF	Units	Conditions
T_J Max. junction operating temperature range	-40 to 150				°C	
T_{stg} Max. storage temperature range	-40 to 150				°C	
R_{thJC} Max. thermal resistance, junction to case	1.36	0.69	0.62	0.47	K/W	DC operation, per junction
R_{thCS} Max. thermal resistance, case to heatsink	0.2				K/W	Mounting surface smooth, flat and greased
T Mounting torque $\pm 10\%$ to heatsink terminals	1.3 $\pm 10\%$				Nm	M3.5 mounting screws (2) non lubricated threads
	3 $\pm 10\%$					M5 screw terminals
wt Approximate weight	54				g	See outline table
Case style	D-56					T type

(2) A mounting compound is recommended and the torque should be rechecked after a period of about 3 hours to allow for the spread of the compound

Ordering Information Table

Device Code

T	110	HF	120
①	②	③	④

- 1 - Module type
- 2 - Current rating
- 3 - Circuit configuration **
- 4 - Voltage code : code x 10 = V_{RRM}

Circuit configuration **

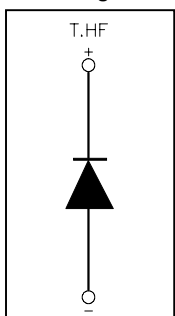

Outline Table

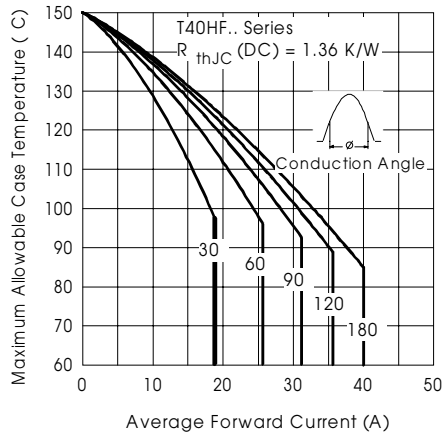
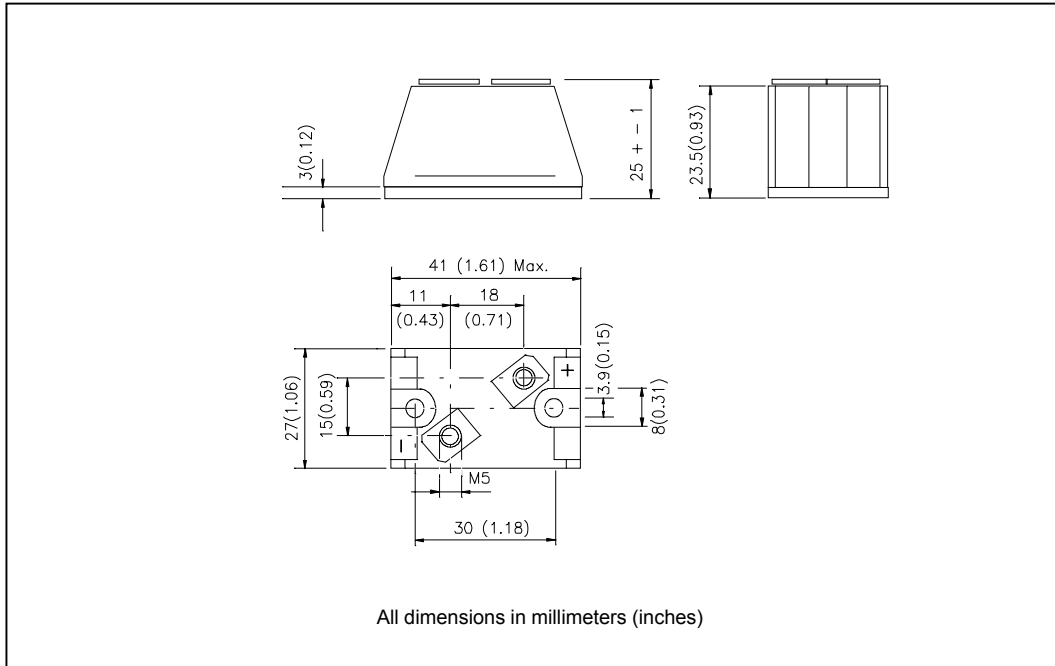

Fig. 1 - Current Ratings Characteristics

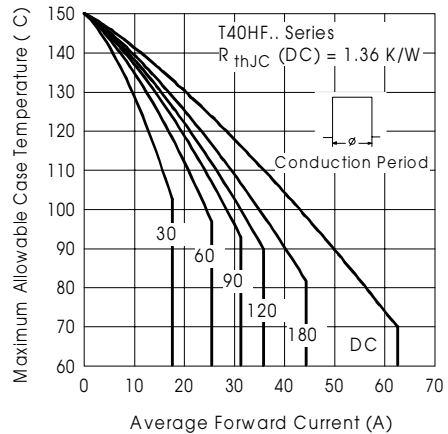

Fig. 2 - Current Ratings Characteristics

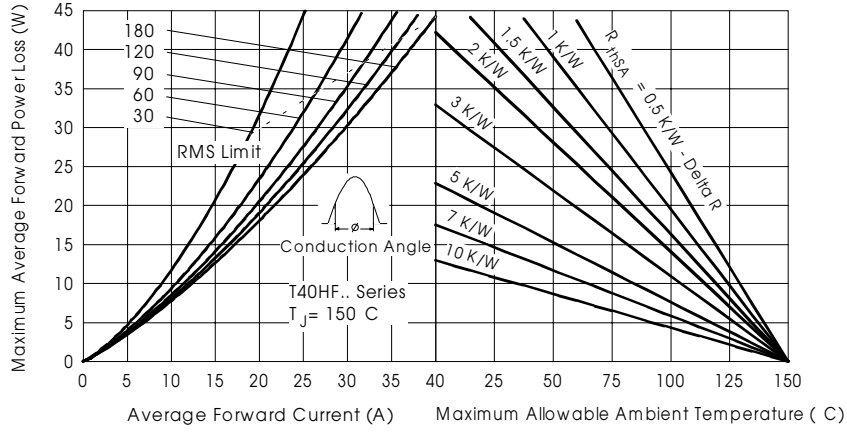

Fig. 3 - Forward Power Loss Characteristics

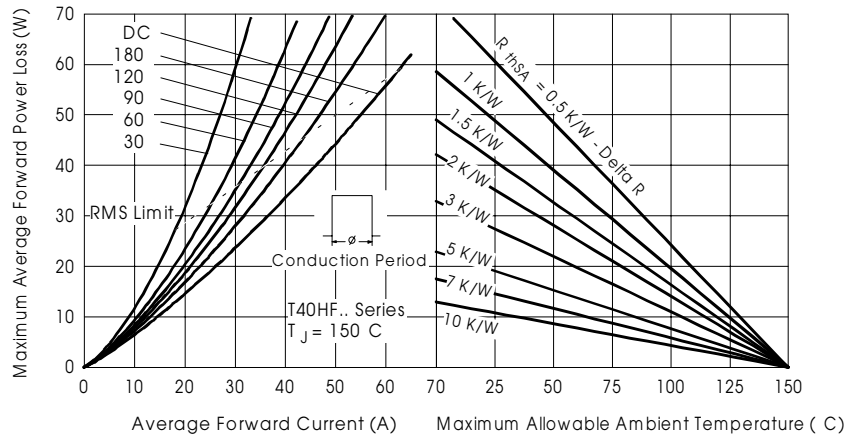

Fig. 4 - Forward Power Loss Characteristics

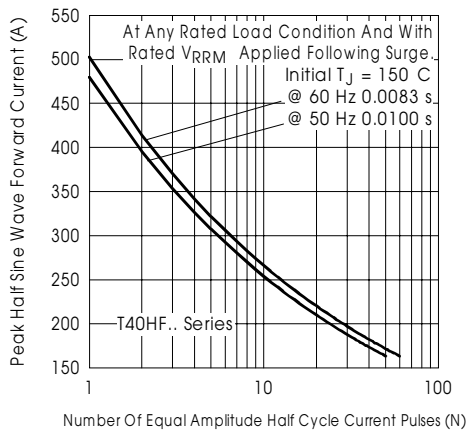

Fig. 5 - Maximum Non-Repetitive Surge Current

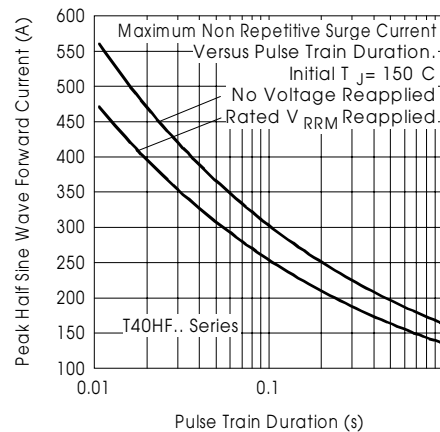

Fig. 6 - Maximum Non-Repetitive Surge Current

T..HF Series

Bulletin I27106 rev. B 02/02

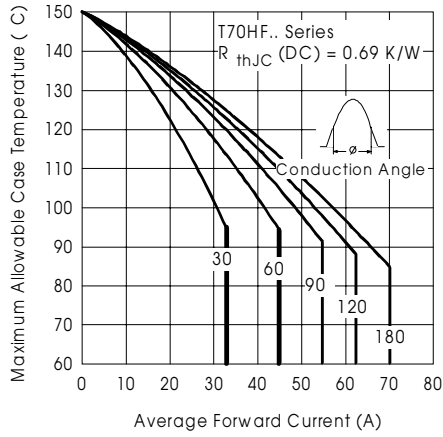

Fig. 7 - Current Ratings Characteristics

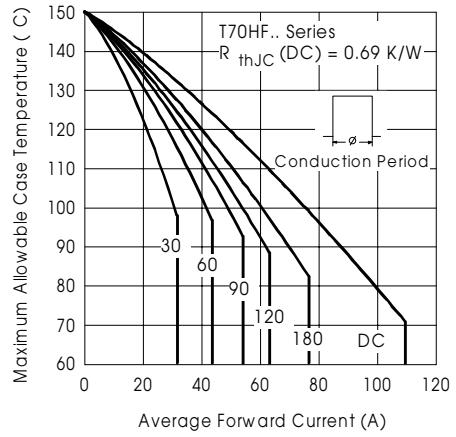

Fig. 8 - Current Ratings Characteristics

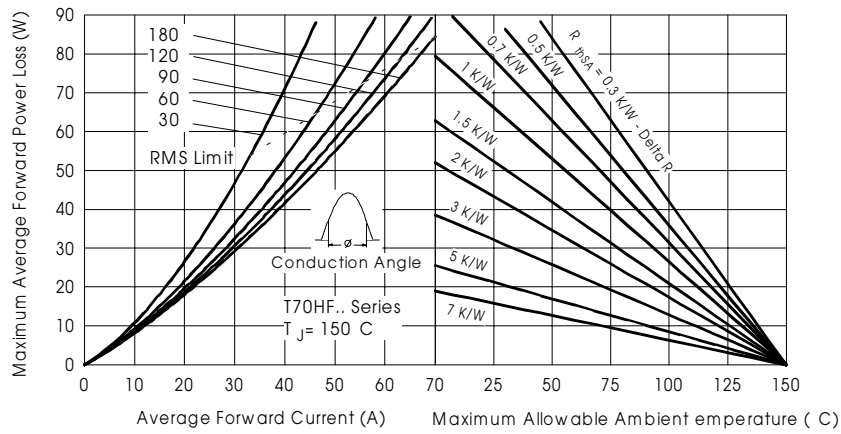

Fig. 9 - Forward Power Loss Characteristics

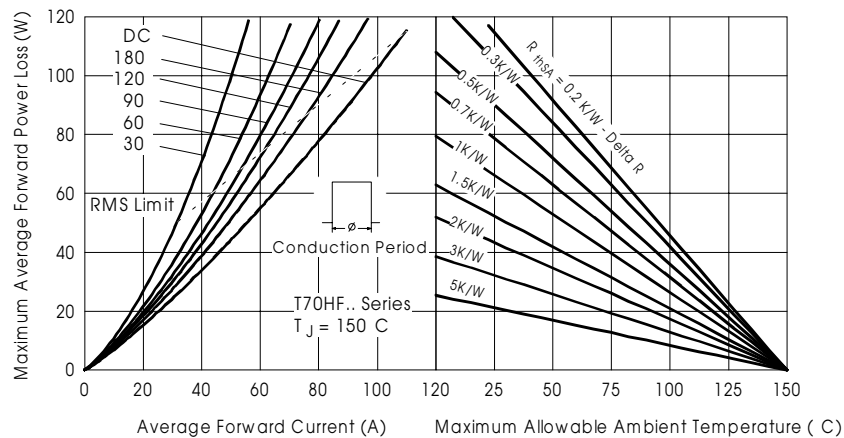

Fig. 10 - Forward Power Loss Characteristics

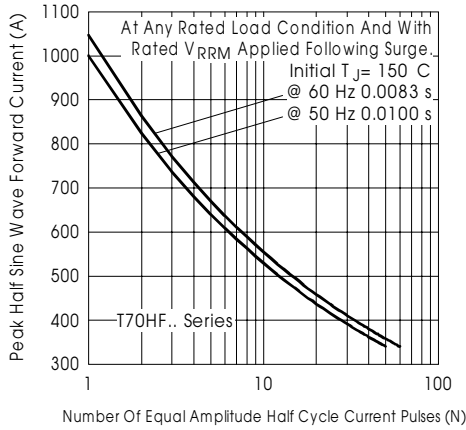

Fig. 11 - Maximum Non-Repetitive Surge Current

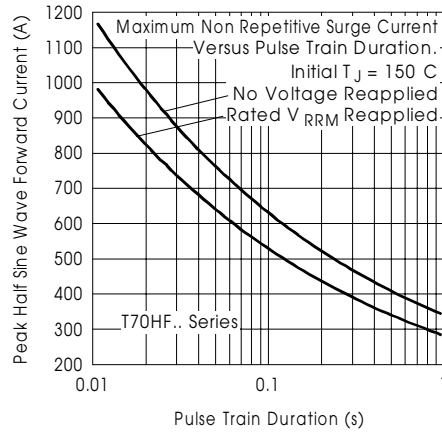

Fig. 12 - Maximum Non-Repetitive Surge Current

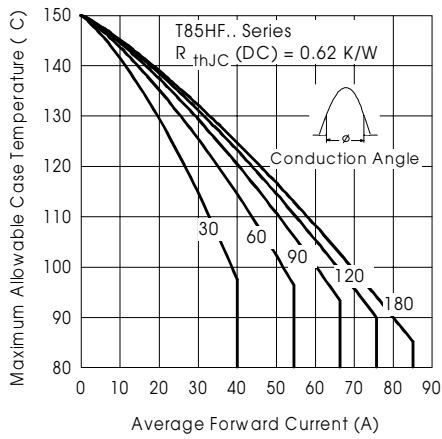

Fig. 13 - Current Ratings Characteristics

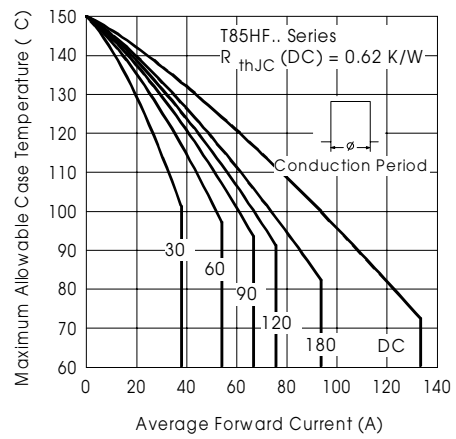

Fig. 14 - Current Ratings Characteristics

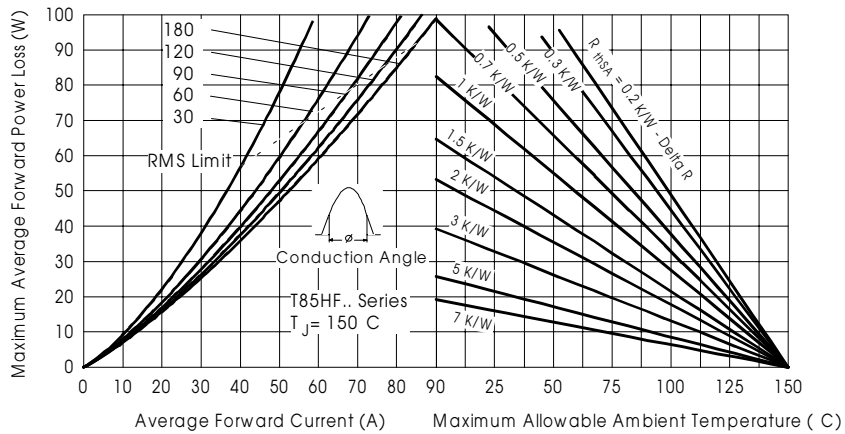

Fig. 15 - Forward Power Loss Characteristics

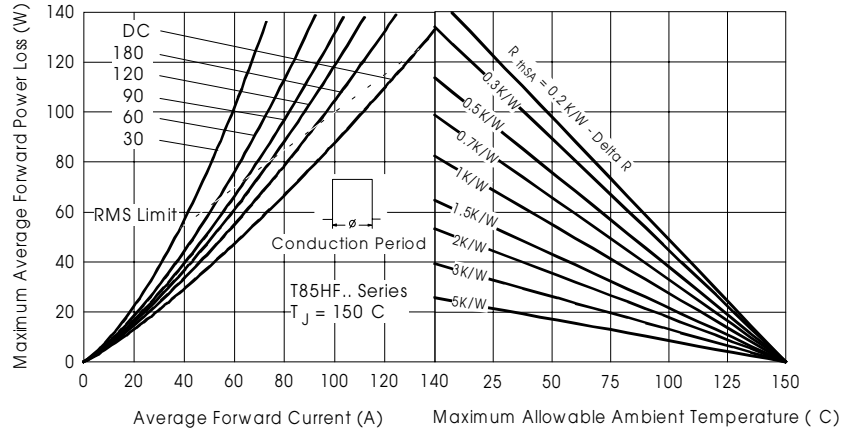

Fig. 16 - Forward Power Loss Characteristics

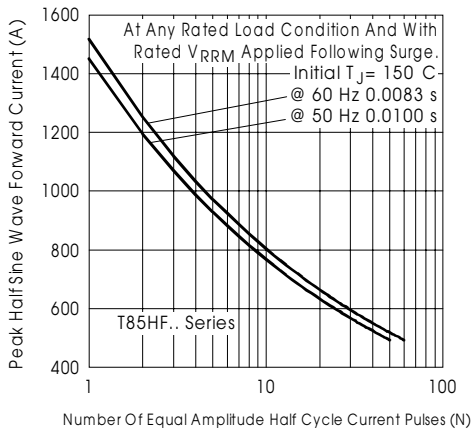

Fig. 17 - Maximum Non-Repetitive Surge Current

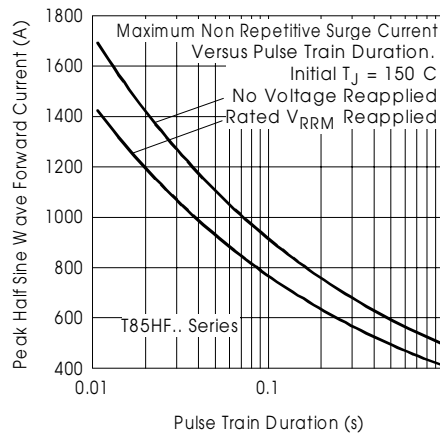

Fig. 18 - Maximum Non-Repetitive Surge Current

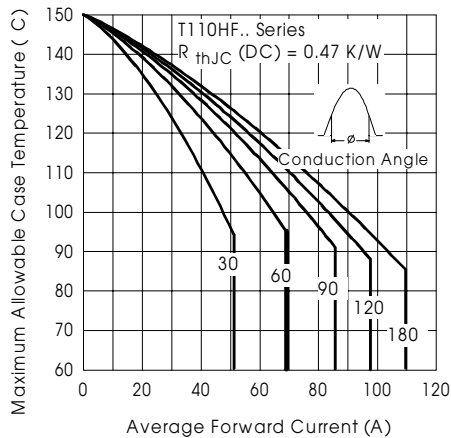

Fig. 19 - Current Ratings Characteristics

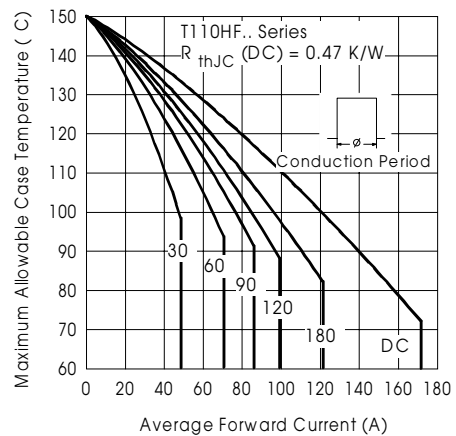

Fig. 20 - Current Ratings Characteristics

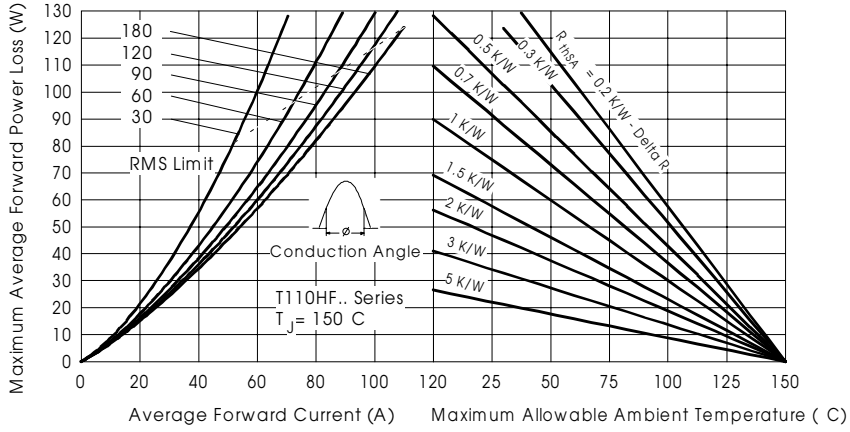

Fig. 21 - Forward Power Loss Characteristics

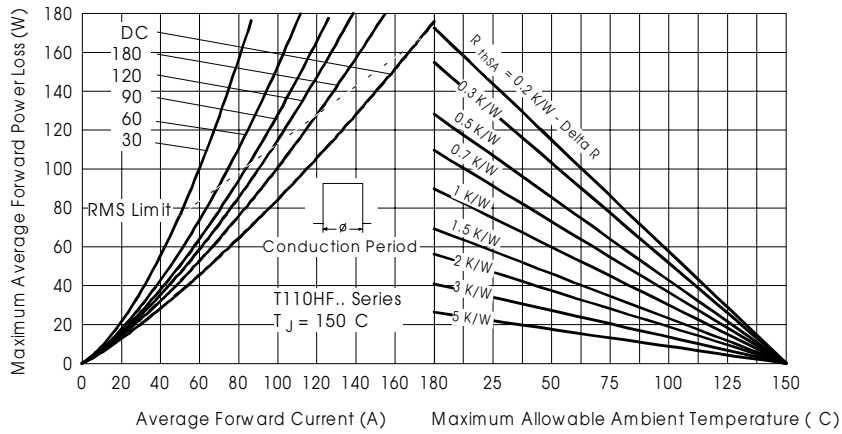

Fig. 22 - Forward Power Loss Characteristics

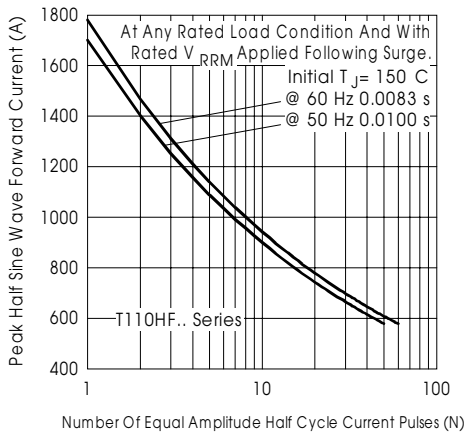

Fig. 23 - Maximum Non-Repetitive Surge Current

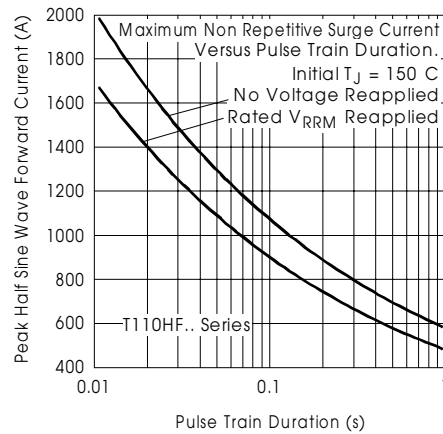

Fig. 24 - Maximum Non-Repetitive Surge Current

T..HF Series

Bulletin I27106 rev. B 02/02

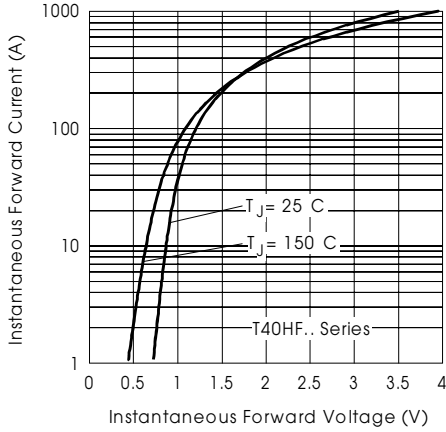

Fig. 25 - Forward Voltage Drop Characteristics

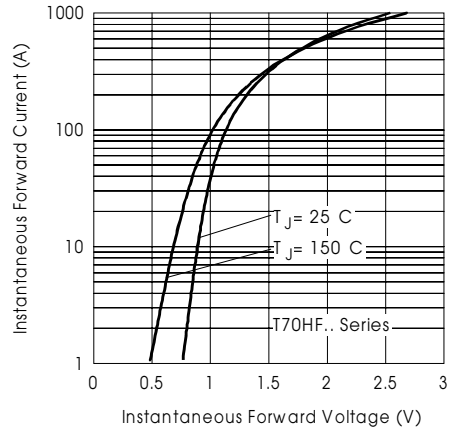

Fig. 26 - Forward Voltage Drop Characteristics

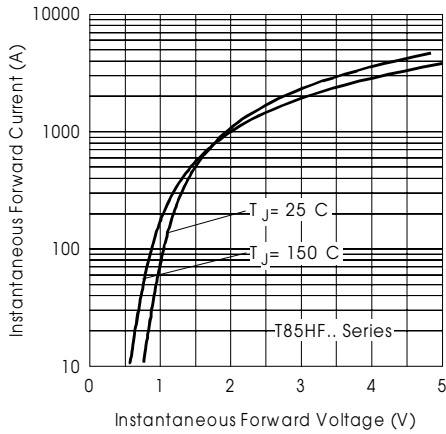

Fig. 27 - Forward Voltage Drop Characteristics

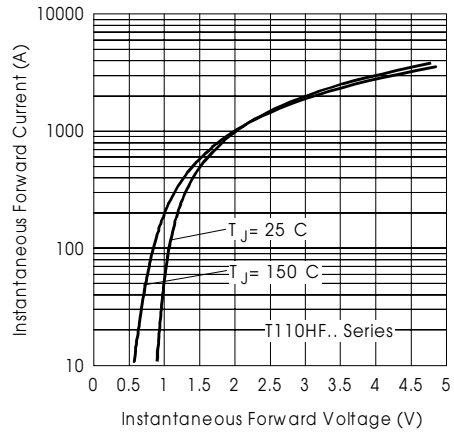

Fig. 28 - Forward Voltage Drop Characteristics

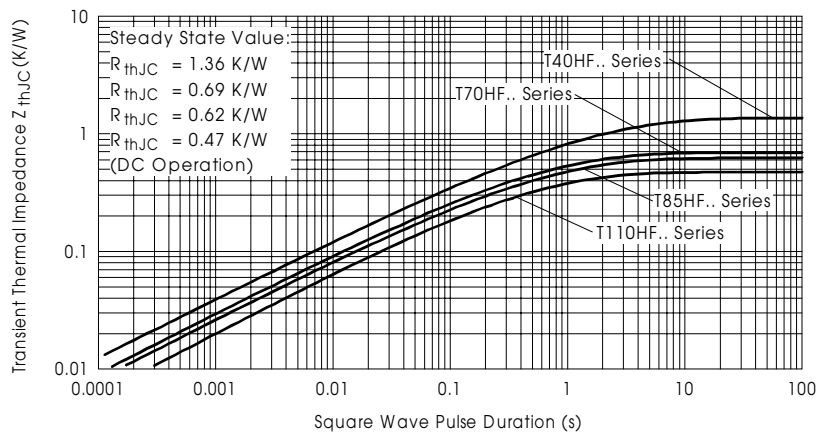

Fig. 29 - Thermal Impedance Z_{thJC} Characteristics

Data and specifications subject to change without notice.
This product has been designed and qualified for Industrial Level.
Qualification Standards can be found on IR's Web site.

International
IOR Rectifier

IR WORLD HEADQUARTERS: 233 Kansas St., El Segundo, California 90245, USA Tel: (310) 252-7105
TAC Fax: (310) 252-7309
Visit us at www.irf.com for sales contact information. 02/02