

Features

- Efficiency up to 97%, Non isolated, no need for heatsinks
- Pin-out compatible with LM78XX Linears
- Low profile (L*W*H=11.5*8.5*17.5mm)
- Wide input range.(4.75V ~ 34V)
- Short circuit protection, Thermal shutdown
- Low ripple and noise
- "L" version with 90° pins
- See InnoLine Application Notes for use as an inverter (alternative to LM79xx Linear)

Description

The R-78Bxx-1.0 Series high efficiency switching regulators are ideally suited to replace 78xx linear regulators and are pin compatible. The efficiency of up to 97% means that very little energy is wasted as heat so there is no need for any heat sinks with their additional space and mounting costs.

The L-Version with 90° pins allows direct replacement for laid-flat regulators where component height is at a premium. Low ripple and noise figures and a short circuit input current of typically only 10mA round off the specifications of this versatile converter series.

Selection Guide

Part Number SIP3	Input Range (V)	Output Voltage (V)	Output Current (A)	Efficiency	
				Min. Vin (%)	Max. Vin (%)
R-78B1.5-1.0	4.75 – 26	1.5	1.0	77	71
R-78B1.8-1.0	4.75 – 26	1.8	1.0	80	74
R-78B2.5-1.0	4.75 – 32	2.5	1.0	85	78
R-78B3.3-1.0	4.75 – 32	3.3	1.0	89	83
R-78B5.0-1.0	6.5 – 32	5.0	1.0	93	88
R-78B6.5-1.0	9.0 – 32	6.5	1.0	94	90
R-78B9.0-1.0	12 – 32	9.0	1.0	95	93
R-78B12-1.0	16 – 32	12	1.0	96	95
R-78B15-1.0	20 – 32	15	1.0	97	96

* add Suffix "L" for 90° bent pins, e.g. R-78B5.0-1.0L

Specifications (refer to the standard application circuit, Ta: 25°C, minimum load = 10%)

Characteristics	Conditions	Min.	Typ.	Max.
Input Voltage Range	1.5V, 1.8V	4.75V	25	26V abs. max.
	2.5V to 15.5V	4.75V	32	34V abs. max.
Output Voltage Range (for customized parts)	All Series	1.5V		15.5V
Output Current (see Note 1)	All Series	0mA*		1000mA
Short Circuit Input Current (Vin = 24V)	All Series			60mA
Internal Power Dissipation				0.65W
Short Circuit Protection			Continuous, automatic recovery	
Output Voltage Accuracy (At 100% Load)	All Series		±2%	±3%
Line Voltage Regulation (Vin = min. to max. at full load)	1.5V to 6.5V		0.2%	0.4%
	9V to 15.5V		0.1%	0.2%
Load Regulation (10% to 100% full load)	1.5V to 6.5V		0.4%	0.6%
	9V to 15.5V		0.25%	0.4%
Dynamic Load Stability (with Output Capacitor=100µF)	100% <-> 50% load		±100mV	±150mV
	Transient Recovery Time		1.0ms	1.5ms
Ripple & Noise (without Output Capacitor) (10% to 100% full load)	1.5V to 6.5V		15mVp-p	20mVp-p
	9V to 15.5V		25mVp-p	35mVp-p
Temperature Coefficient	-40°C ~ +85°C ambient			0.015%/°C

continued on next page

INNOLINE DC/DC-Converter

with 3 year Warranty

RECOM

1.0 AMP SIP3 Single Output



EN-55022 Certified
EN-55024 Certified
EN-60601-1-2 Certified
IEC/EN-60950-1 Certified

R-78B-1.0

Derating-Graph (Ambient Temperature)

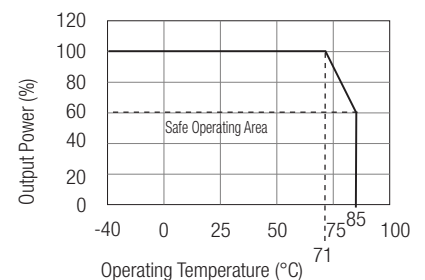

Refer to Application Notes

Specifications (refer to the standard application circuit, Ta: 25°C, minimum load = 10%)

Characteristics	Conditions	Min.	Typ.	Max.
Max capacitance Load	with normal start-up time, no external components			470µF
	with <1 second start up time + diode protection circuit			6800µF
Switching Frequency		280kHz	330kHz	380kHz
Quiescent Current	Vin = min. to max. at 0% load		5mA	7mA
Input Reflected Ripple Current	All Series		150mA	200mA p-p
Operating Temperature Range		-40°C		+85°C
Operating Case Temperature				+100°C
Storage Temperature Range		-55°C		+125°C
Case Thermal Impedance				60°C / W
Relative Humidity				95% RH
Case Material		Epoxy with Non-Conductive Plastic Case (UL94V-0)		
Package Weight			4g	
Packing Quantity				42 pcs per Tube
Conducted Emissions	EN55022			Class B
Radiated Emissions	EN55022			Class B
ESD	EN61000-4-2			Class A
IEC/EN General Safety	Report: SPCLVD 1407030-1		IEC/EN-60950-1, 2nd Edition	
MTBF (+25°C) (+71°C)	} Detailed Information see Application Notes chapter "MTBF"	using MIL-HDBK 217F		6584 x 10 ³ hours
		using MIL-HDBK 217F		1139 x 10 ³ hours

*Note: Operation under no load will not damage these devices, however they may not meet all specifications. A minimum load of 10mA is recommended

Typical Application Circuit

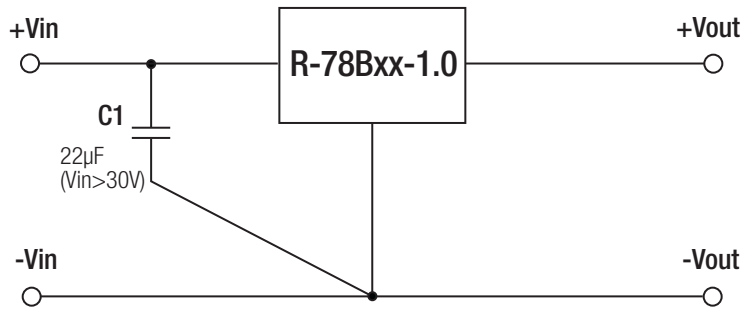

To protect the converter during power-up, use C1=22µF if Vin>30V

Characteristics

Efficiency

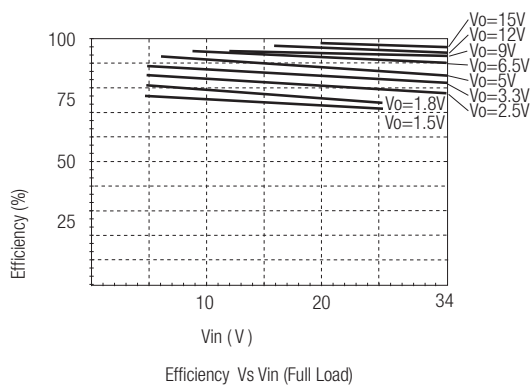

Ripple

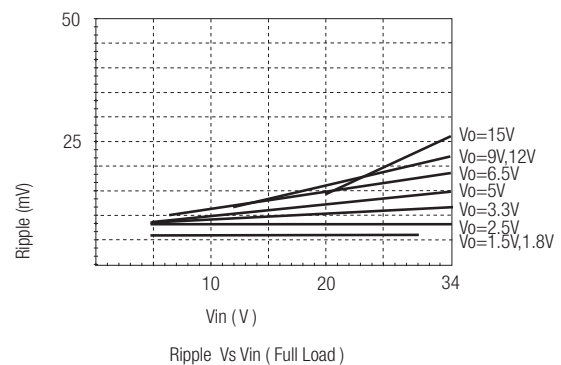

Characteristics

Efficiency

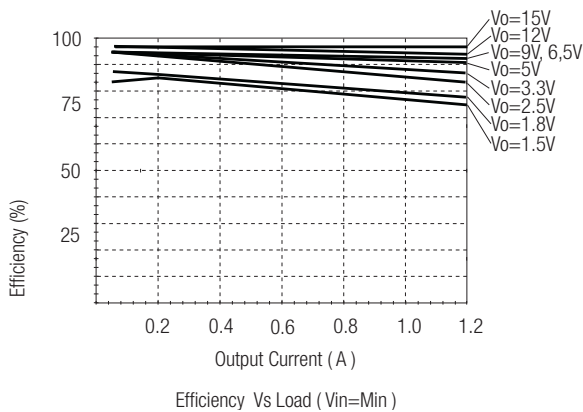
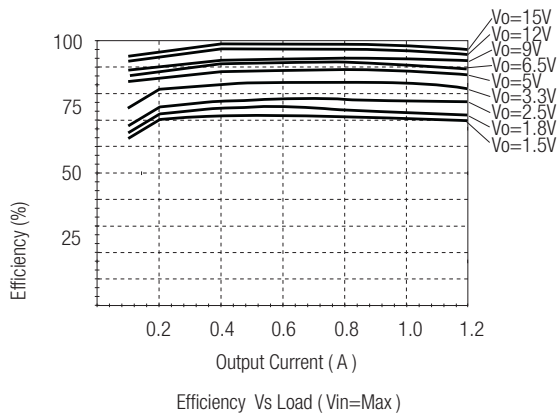

Ripple

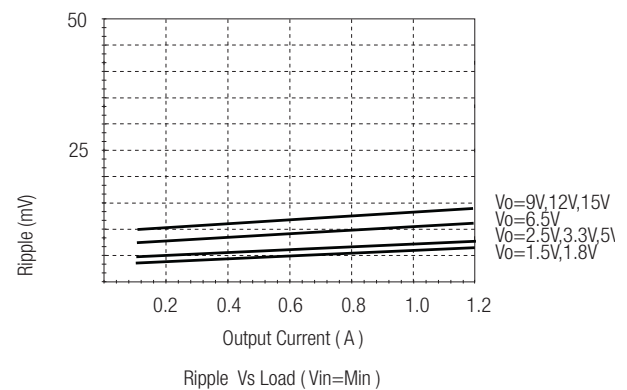
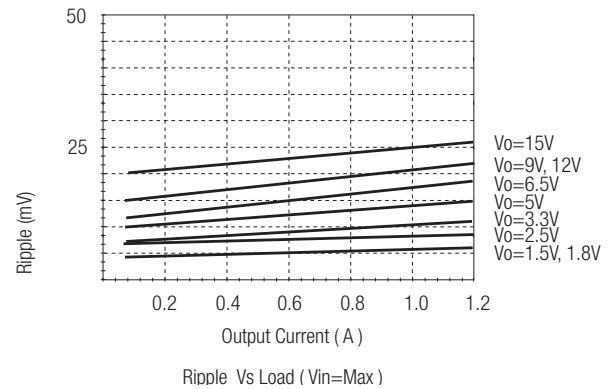

Optional Protection Circuit

Optional Protection 1:

Add a blocking diode to Vout if current can flow backwards into the output, as this can damage the converter when it is powered down.

The diode can either be fitted across the device if the source is low impedance or fitted in series with the output (recommended).

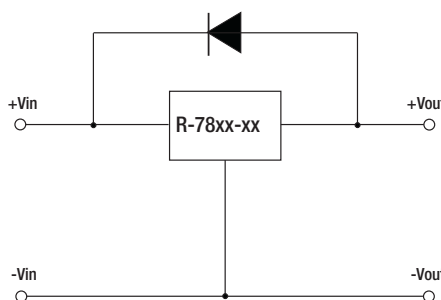

Optional Protection 2:

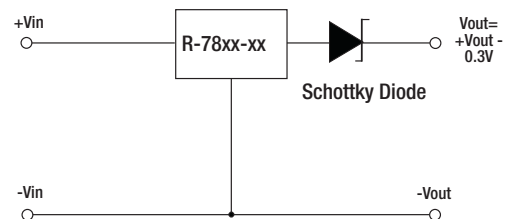

Application Examples

High efficiency multiple output

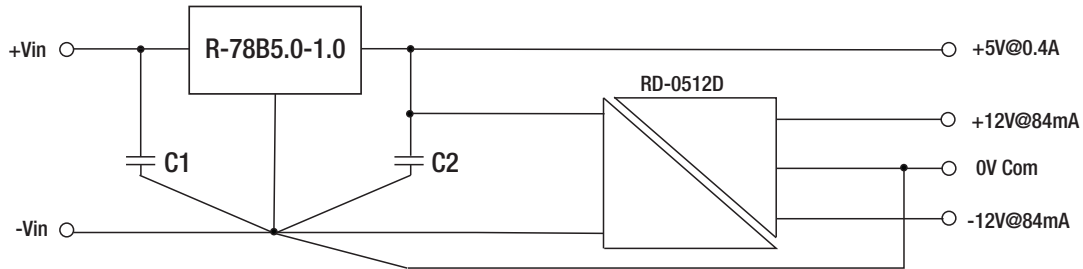

- C1: optional, C2: required (further decoupling filtering may be necessary between the two converters)
- Wide input range 6.5V to 34V
 - +/-12V outputs for analogue circuits, e.g. instrumentation amplifier
 - +5V output for digital circuits

Isolated, wide Input range, Distributed Power Architecture (Point of Load)

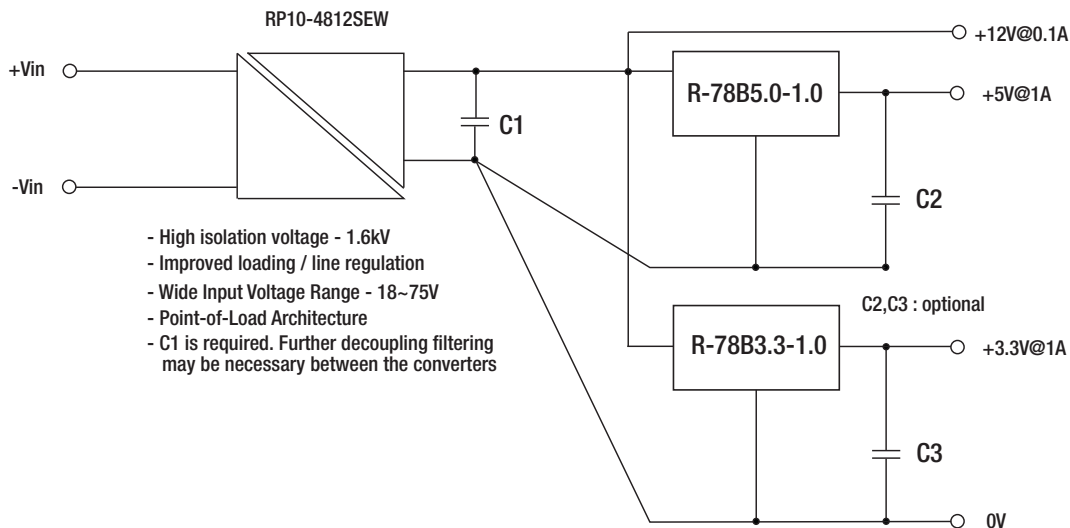

- High isolation voltage - 1.6kV
 - Improved loading / line regulation
 - Wide Input Voltage Range - 18~75V
 - Point-of-Load Architecture
 - C1 is required. Further decoupling filtering may be necessary between the converters
- C2,C3 : optional

R-78B-1.0

Package Style and Pinning (mm)

SIP3 PIN Package

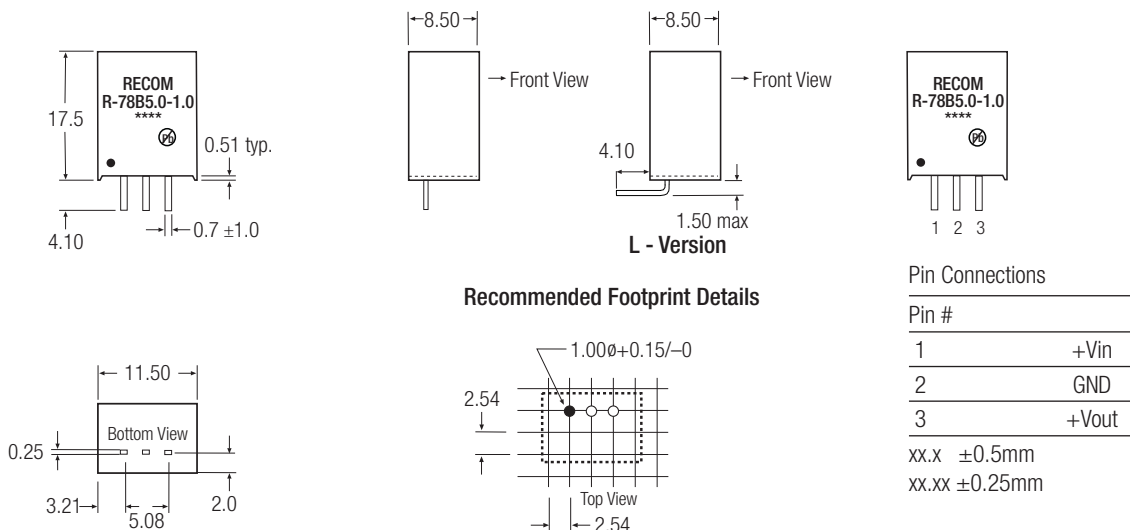

Pin Connections

Pin #	Connection
1	+Vin
2	GND
3	+Vout

xx.x ±0.5mm
xx.xx ±0.25mm

The product information and specifications are subject to change without prior notice. RECOM products are not authorized for use in safety-critical applications (such as life support) without RECOM's explicit written consent. A safety-critical application is defined as an application where a failure of a RECOM product may reasonably be expected to endanger or cause loss of life, inflict bodily harm or damage property. The buyer shall indemnify and hold harmless RECOM, its affiliated companies and its representatives against any damage claims in connection with the unauthorized use of RECOM products in such safety-critical applications.

Mouser Electronics

Authorized Distributor

Click to View Pricing, Inventory, Delivery & Lifecycle Information:

RECOM:

[R-78B12-1.0](#) [R-78B3.3-1.0](#) [R-78B5.0-1.0](#) [R-78B6.5-1.0](#) [R-78B1.5-1.0](#) [R-78B1.5-1.0L](#) [R-78B1.8-1.0](#) [R-78B1.8-1.0L](#)
[R-78B12-1.0L](#) [R-78B15-1.0](#) [R-78B15-1.0L](#) [R-78B2.5-1.0](#) [R-78B2.5-1.0L](#) [R-78B3.3-1.0L](#) [R-78B5.0-1.0L](#) [R-78B6.5-1.0L](#) [R-78B9.0-1.0](#) [R-78B9.0-1.0L](#)