T-1³/₄ (5 mm), T-1 (3 mm), Ultra-Bright LED Lamps

Technical Data

**HLMP-3750, -3850, -3950,
-3960**

HLMP-3390, -3490, -3590

HLMP-1340, -1440, -1540

HLMP-D640

HLMP-K640

Features

- Improved Brightness
- Improved Color Performance
- Available in Popular T-1 and T-1³/₄ Packages
- New Sturdy Leads
- IC Compatible/Low Current Capability
- Reliable and Rugged
- Choice of 3 Bright Colors
 - High Efficiency Red
 - High Brightness Yellow
 - High Performance Green

Applications

- Lighted Switches
- Backlighting Front Panels
- Light Pipe Sources
- Keyboard Indicators

Description

These non-diffused lamps outperform conventional LED lamps. By utilizing new higher intensity material, we achieve superior product performance.

The HLMP-3750/-3390/-1340 Series Lamps are Gallium Arsenide Phosphide on Gallium Phosphide red light emitting diodes. The HLMP-3850/



-3490/-1440 Series are Gallium Arsenide Phosphide on Gallium Phosphide yellow light emitting diodes. The HLMP-3950/-3590/-3960/-1540/-D640/-K640 Series Lamps are Gallium Phosphide green light emitting diodes.

Selection Guide

Package Description	Color	Device HLMP-	Luminous Intensity I _v (mcd) @ 20 mA			2 _θ ^{1/2[1]} Degree	Package Outline
			Min.	Typ.	Max.		
T-1 ^{3/4}	Red	3750	90.0	125.0	–	24	A
		3750-L00xx	90.0	125.0	–	24	A
		3750-LM0xx	90.0	125.0	276.0	24	A
	Yellow	3850	96.0	140.0	–	24	A
		3850-K00xx	96.0	140.0	–	24	A
		3850-KL0xx	96.0	150.0	294.0	24	A
		3850-KLBxx	96.0	150.0	294.0	24	A
	Green	3950	111.0	265.0	–	24	A
		3950-K00xx	111.0	265.0	–	24	A
		3950-LM0xx	170.0	300.0	490.0	24	A
		3960-K0xxx	111.0	265.0	–	24	E
		3960-LMxxx	170.0	300.0	490.0	24	E
	Emerald Green ^[2]	D640	6.7	21.0	–	24	D
		D640-E00xx	6.7	21.0	–	24	D
T-1 ^{3/4} Low Profile	Red	3390	35.2	55.0	–	32	B
		3390-J00xx	35.2	55.0	–	32	B
	Yellow	3490	37.6	55.0	–	32	B
		3490-100xx	37.6	55.0	–	32	B
	Green	3590	43.6	55.0	–	32	B
		3590-100xx	43.6	55.0	–	32	B
T-1	Red	1340	35.2	55.0	–	45	C
		1340-GH0xx	8.6	15.0	27.6	45	C
		1340-J00xx	35.2	55.0	–	45	C
		1340-JK0xx	35.2	55.0	112.8	45	C
	Yellow	1440	23.5	45.0	–	45	C
		1440-H00xx	23.5	45.0	–	45	C
		1440-HI0xx	23.5	45.0	75.2	45	C
		1440-HIBxx	23.5	45.0	75.2	45	C
	Green	1540	27.3	45.0	–	45	C
		1540-H00xx	27.3	45.0	–	45	C
		1540-IJ0xx	43.6	60.0	139.6	45	C
	Emerald Green ^[2]	K640	4.2	21.0	–	45	C
		K640-D00xx	4.2	21.0	–	45	C
		K640-FGNxx	10.6	20.0	34.0	45	C

Package Dimensions

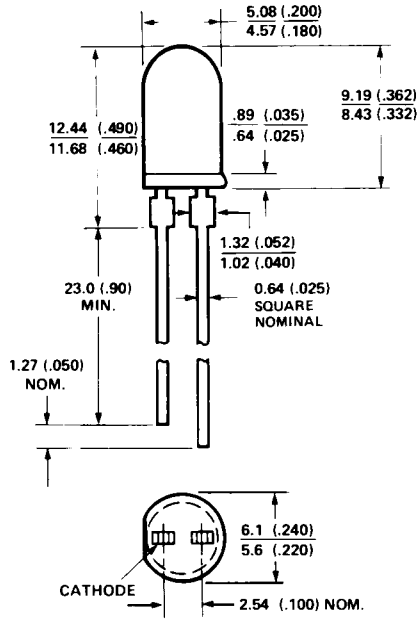

PACKAGE OUTLINE "A"
HLMP-3750, -3850, -3950

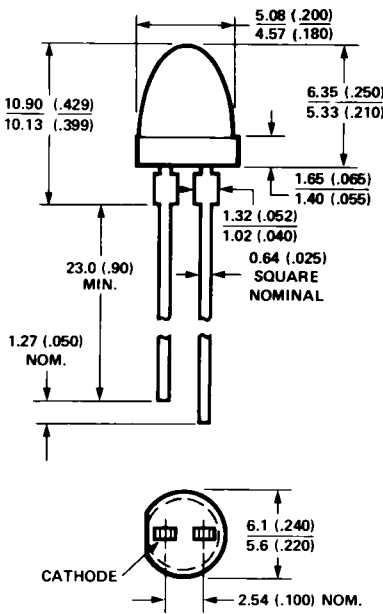

PACKAGE OUTLINE "B"
HLMP-3390, -3490, -3590

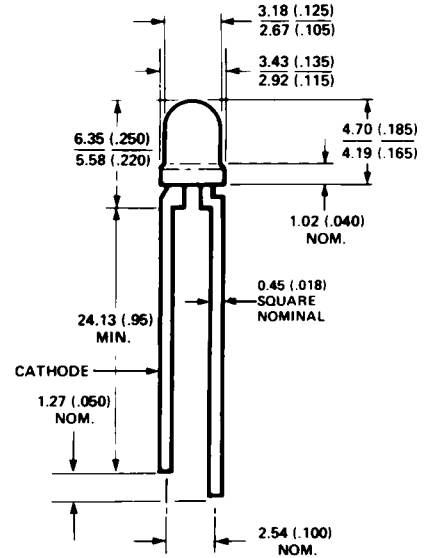

PACKAGE OUTLINE "C"
HLMP-1340, -1440, -1540

NOTES:
 1. ALL DIMENSIONS ARE IN MILLIMETERS (INCHES).
 2. AN EPOXY MENISCUS MAY EXTEND ABOUT 1 mm (0.40") DOWN THE LEADS.

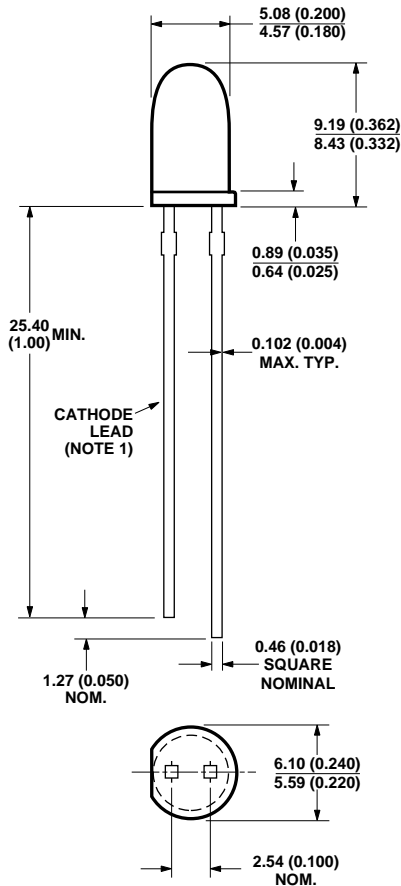

PACKAGE OUTLINE "D"
HLMP-D640

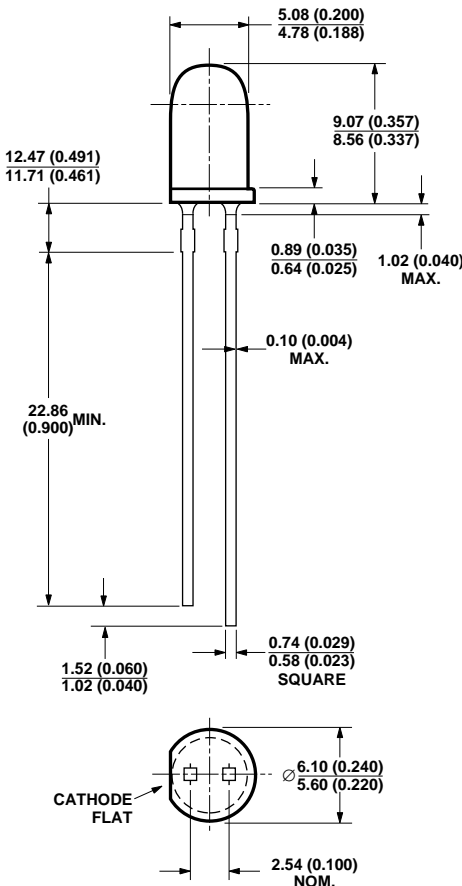

PACKAGE OUTLINE "E"
HLMP-3960

Part Numbering System

HLMP - x x xx - x x x xx

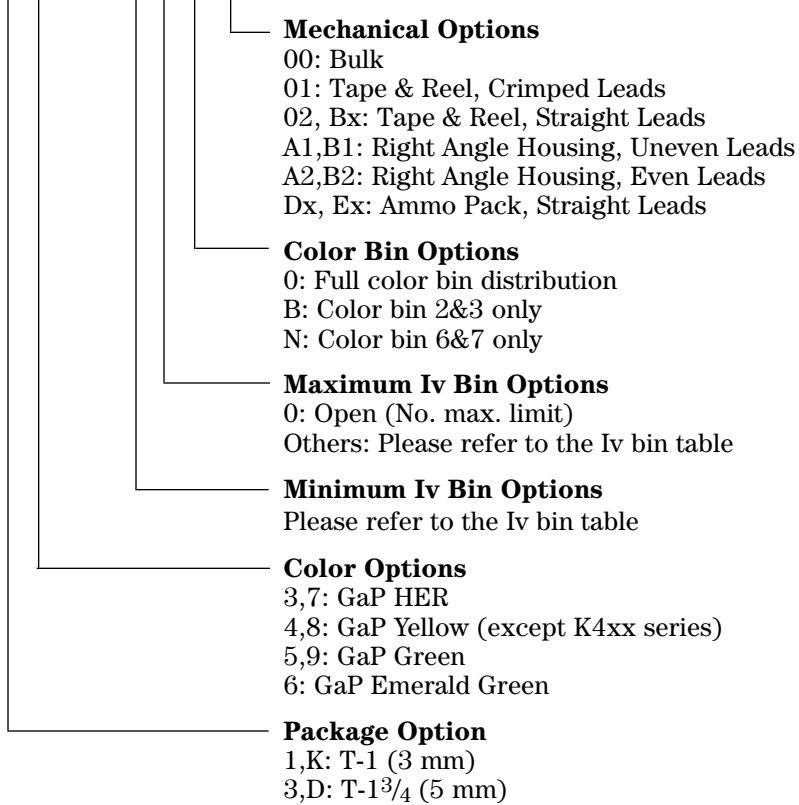

Absolute Maximum Ratings at $T_A = 25^\circ\text{C}$

Parameter	Red	Yellow	Green/Emerald Green	Units
Peak Forward Current	90	60	90	mA
Average Forward Current ^[1]	25	20	25	mA
DC Current ^[2]	30	20	30	mA
Transient Forward Current ^[3] (10 μs Pulse)	500	500	500	mA
Reverse Voltage ($I_R = 100 \mu\text{A}$)	5	5	5	V
LED Junction Temperature	110	110	110	$^\circ\text{C}$
Operating Temperature Range	-55 to +100	-55 to +100	-20 to +100	$^\circ\text{C}$
Storage Temperature Range			-55 to +100	
Lead Soldering Temperature [1.6 mm (0.063 in.) from body]	260 $^\circ\text{C}$ for 5 seconds			

Notes:

- See Figure 2 to establish pulsed operating conditions.
- For Red and Green series derate linearly from 50 $^\circ\text{C}$ at 0.5 mA/ $^\circ\text{C}$. For Yellow series derate linearly from 50 $^\circ\text{C}$ at 0.2 mA/ $^\circ\text{C}$.
- The transient peak current is the maximum non-recurring peak current the devices can withstand without damaging the LED die and wire bonds. It is not recommended that the device be operated at peak currents beyond the Absolute Maximum Peak Forward Current.

Electrical/Optical Characteristics at $T_A = 25^\circ\text{C}$

Symbol	Description	T-1 ^{3/4}	T-1 ^{3/4} Low Dome	T-1	Min.	Typ.	Max.	Units	Test Conditions
λ_{PEAK}	Peak Wavelength	3750 3850 3950 & 3960 D640	3390 3490 3590	1340 1440 1540 K640		635 583 565 558		nm	Measurement at Peak
λ_d	Dominant Wavelength	3750 3850 3950 & 3960 D640	3390 3490 3590	1340 1440 1540 K640		626 585 569 560		nm	Note 1
$\Delta\lambda^{1/2}$	Spectral Line Halfwidth	3750 3850 3950 & 3960 D640	3390 3490 3590	1340 1440 1540 K640		40 36 28 24		nm	
τ_s	Speed of Response	3750 3850 3950 & 3960 D640	3390 3490 3590	1340 1440 1540 K640		90 90 500 3100		ns	
C	Capacitance	3750 3850 3950 & 3960 D640	3390 3490 3590	1340 1440 1540 K640		11 15 18 35		pF	$V_F = 0, f = 1 \text{ MHz}$
$R\theta_{\text{J-PIN}}$	Thermal Resistance	3750 3850 3950 & 3960 D640	3390 3490 3590	1340 1440 1540 K640		210 210 210 510 290 290 290 290		$^\circ\text{C/W}$	Junction to Cathode Lead
V_F	Forward Voltage	3750 3850 3950 & 3960 D640	3390 3490 3590	1340 1440 1540 K640	1.5 1.5 1.5	1.9 2.1 2.2 2.2	2.6 2.6 3.0 3.0	V	$I_F = 20 \text{ mA}$ (Figure 3)
V_R	Reverse Breakdown Voltage	3750 3850 3950 & 3960 D640	3390 3490 3590	1340 1440 1540 K640	5.0			V	$I_F = 100 \mu\text{A}$
η_V	Luminous Efficacy	3750 3850 3950 & 3960 D640	3390 3490 3590	1340 1440 1540 K640		145 500 595 655		$\frac{\text{lumens}}{\text{watt}}$	Note 2

Notes:

- The dominant wavelength, λ_d , is derived from the CIE chromaticity diagram and represents the single wavelength which defines the color of the device.
- The radiant intensity, I_e , in watts per steradian, may be found from the equation $I_e = I_v/\eta_V$, where I_v is the luminous intensity in candelas and η_V is the luminous efficacy in lumens/watt.

Red, Yellow, and Green

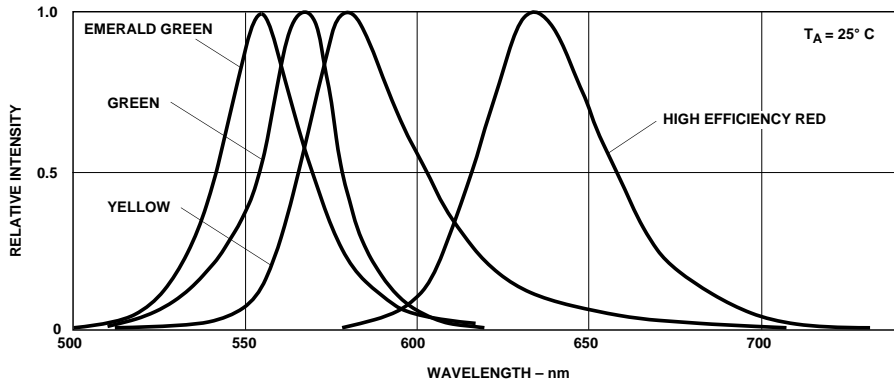

Figure 1. Relative Intensity vs. Wavelength.

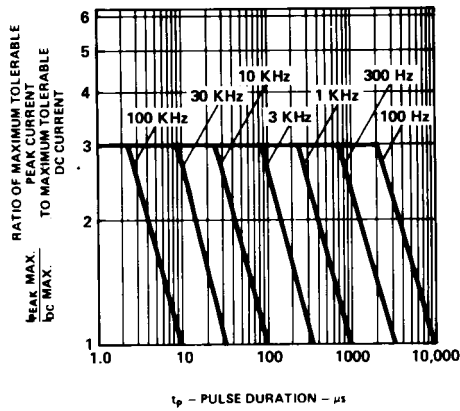

Figure 2. Maximum Tolerable Peak Current vs. Pulse Duration. (I_{DC} MAX as per MAX Ratings).

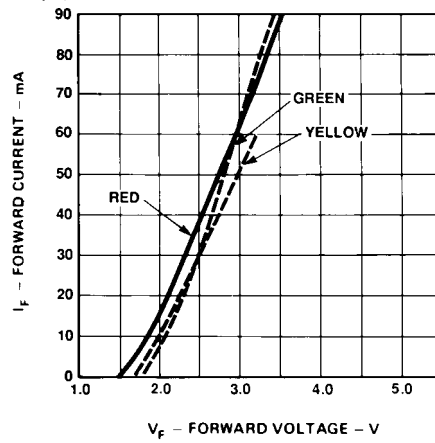

Figure 3. Forward Current vs. Forward Voltage.

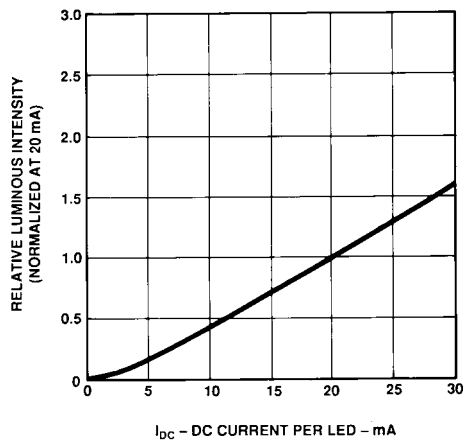

Figure 4. Relative Luminous Intensity vs. Forward Current.

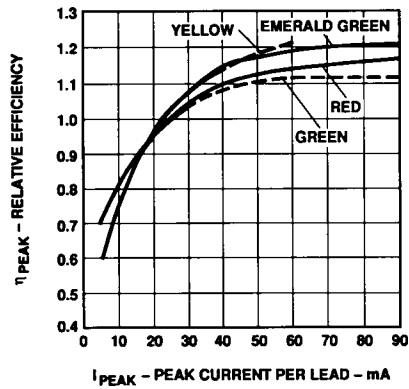

Figure 5. Relative Efficiency (Luminous Intensity per Unit Current) vs. Peak Current.

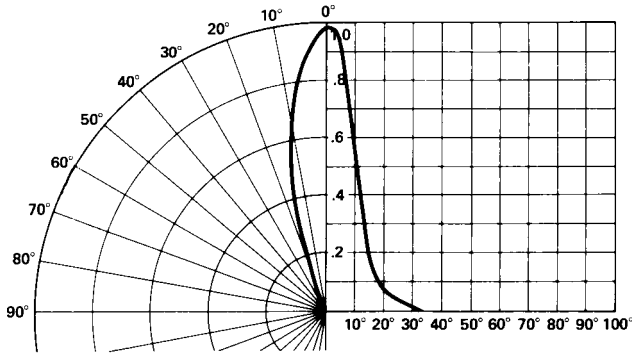

Figure 6. Relative Luminous Intensity vs. Angular Displacement. T-1^{3/4} Lamp.

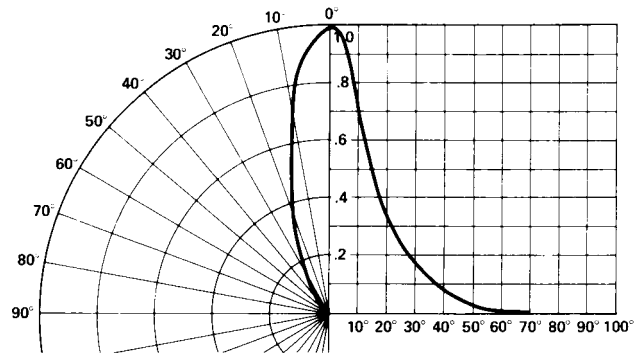

Figure 7. Relative Luminous Intensity vs. Angular Displacement. T-1^{3/4} Low Profile Lamp.

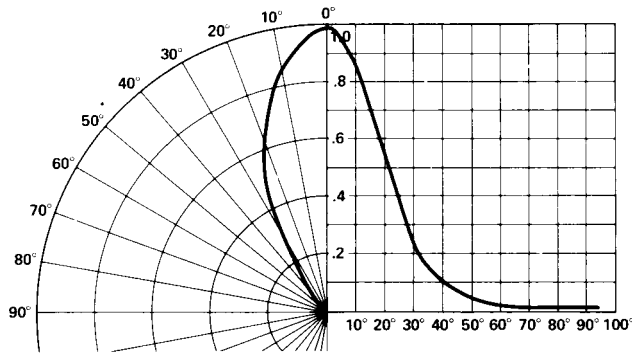

Figure 8. Relative Luminous Intensity vs. Angular Displacement. T-1 Lamp.

Intensity Bin Limits

Intensity Bin Limits

Color	Bin	Intensity Range (mcd)	
		Min.	Max.
Red	G	9.7	15.5
	H	15.5	24.8
	I	24.8	39.6
	J	39.6	63.4
	K	63.4	101.5
	L	101.5	162.4
	M	162.4	234.6
	N	234.6	340.0
	O	340.0	540.0
	P	540.0	850.0
	Q	850.0	1200.0
	R	1200.0	1700.0
	S	1700.0	2400.0
	T	2400.0	3400.0
	U	3400.0	4900.0
	V	4900.0	7100.0
	W	7100.0	10200.0
X	10200.0	14800.0	
Y	14800.0	21400.0	
Z	21400.0	30900.0	

Maximum tolerance for each bin limit is ± 18%.

Intensity Bin Limits (continued)

Color	Bin	Intensity Range (mcd)		
		Min.	Max.	
Yellow	H	26.5	42.3	
	I	42.3	67.7	
	J	67.7	108.2	
	K	108.2	173.2	
	L	173.2	250.0	
	M	250.0	360.0	
	N	360.0	510.0	
	O	510.0	800.0	
	P	800.0	1250.0	
	Q	1250.0	1800.0	
	R	1800.0	2900.0	
	S	2900.0	4700.0	
	T	4700.0	7200.0	
	U	7200.0	11700.0	
	V	11700.0	18000.0	
	W	18000.0	27000.0	
	Green/ Emerald Green	A	1.1	1.8
		B	1.8	2.9
C		2.9	4.7	
D		4.7	7.6	
E		7.6	12.0	
F		12.0	19.1	
G		19.1	30.7	
H		30.7	49.1	
I		49.1	78.5	
J		78.5	125.7	
K		125.7	201.1	
L		201.1	289.0	
M		289.0	417.0	
N		417.0	680.0	
O		680.0	1100.0	
P		1100.0	1800.0	
Q		1800.0	2700.0	
R		2700.0	4300.0	
S	4300.0	6800.0		
T	6800.0	10800.0		
U	10800.0	16000.0		
V	16000.0	25000.0		
W	25000.0	40000.0		

Maximum tolerance for each bin limit is $\pm 18\%$.

Color Categories

Color	Cat #	Lambda (nm)	
		Min.	Max.
Emerald Green	9	552.5	555.5
	8	555.5	558.5
	7	558.5	561.5
	6	561.5	564.5
Green	6	561.5	564.5
	5	564.5	567.5
	4	567.5	570.5
	3	570.5	573.5
	2	573.5	576.5
Yellow	1	582.0	584.5
	3	584.5	587.0
	2	587.0	589.5
	4	589.5	592.0
	5	592.0	593.0
Orange	1	597.0	599.5
	2	599.5	602.0
	3	602.0	604.5
	4	604.5	607.5
	5	607.5	610.5
	6	610.5	613.5
	7	613.5	616.5
	8	616.5	619.5

Maximum tolerance for each bin limit is $\pm 0.5\text{nm}$.

Mechanical Option Matrix

Mechanical Option Code	Definition
00	Bulk Packaging, minimum increment 500 pcs/bag
01	Tape & Reel, crimped leads
02	Tape & Reel, straight leads
A1	T1, Right Angle Housing, uneven leads, minimum increment 500 pcs/bag
A2	T1, Right Angle Housing, even leads, minimum increment 500 pcs/bag
B1	T1 ^{3/4} , Right Angle Housing, uneven leads, minimum increment 500 pcs/bag
B2	T1 ^{3/4} , Right Angle Housing, even leads, minimum increment 500 pcs/bag
BJ	Tape & Reel, straight leads in 2K increment
DC	Ammo Pack, straight leads in 2K increment
DG	Ammo Pack, straight leads in 2K increment
EG	Ammo Pack, straight leads in 5K increment

All categories are established for classification of products. Products may not be available in all categories. Please contact your local Agilent representative for further clarification/information.

www.agilent.com/semiconductors

For product information and a complete list of distributors, please go to our web site.

For technical assistance call:

Americas/Canada: +1 (800) 235-0312 or
(408) 654-8675

Europe: +49 (0) 6441 92460

China: 10800 650 0017

Hong Kong: (+65) 271 2451

India, Australia, New Zealand: (+65) 271 2394

Japan: (+81 3) 3335-8152(Domestic/International), or 0120-61-1280(Domestic Only)

Korea: (+65) 271 2194

Malaysia, Singapore: (+65) 271 2054

Taiwan: (+65) 271 2654

Data subject to change.

Copyright © 2002 Agilent Technologies, Inc.

Obsoletes 5988-3491EN

March 13, 2002

5988-4758EN