

High-current terminal block - PTPOWER 50-3L - 3260053

Please be informed that the data shown in this PDF Document is generated from our Online Catalog. Please find the complete data in the user's documentation. Our General Terms of Use for Downloads are valid (<http://phoenixcontact.com/download>)

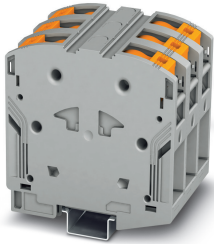

High-current terminal block, Blocked, nom. voltage: 1000 VAC / 1500 VDC, nominal current: 150 A, connection method: Power-Turn connection, number of connections: 6, number of positions: 3, cross section: 10 mm² - 70 mm², AWG: 8 - 2/0, width: 60 mm, color: gray, mounting type: NS 35/15

Your advantages

- ✓ Quick and easy connection is now also possible for large conductors with the high-current terminal block
- ✓ The compact design enables wiring in a confined space
- ✓ In addition to using the existing test connection, pick-off terminal blocks can be connected, each of which can also accommodate two test cables
- ✓ The Push-in connection terminal blocks are characterized by the system features of the CLIPLINE complete system and by easy and tool-free wiring of conductors with ferrules or solid conductors



Key Commercial Data

Packing unit	1 pc
Minimum order quantity	3 pc
GTIN	 4 046356 998659
GTIN	4046356998659
Weight per Piece (excluding packing)	473.330 g
Custom tariff number	85369010
Country of origin	Poland

Technical data

General

Number of positions	3
Number of levels	1
Number of connections	6
Potentials	1

High-current terminal block - PTPOWER 50-3L - 3260053

Technical data

General

Nominal cross section	50 mm ²
Color	gray
Insulating material	PA
Flammability rating according to UL 94	V0
Rated surge voltage	8 kV
Degree of pollution	3
Overvoltage category	III
Insulating material group	I
Maximum power dissipation for nominal condition	4.73 W
Maximum load current	150 A (with 50 mm ² conductor cross section)
Nominal current I _N	150 A
Nominal voltage U _N	1000 VAC
	1500 VDC
Open side panel	No
Ambient temperature (operation)	-60 °C ... 105 °C (max. short-term operating temperature 130 °C)
Ambient temperature (storage/transport)	-25 °C ... 60 °C (for a short time, not exceeding 24h, -60 °C to +70 °C)
Permissible humidity (storage/transport)	30 % ... 70 %
Ambient temperature (assembly)	-5 °C ... 70 °C
Ambient temperature (actuation)	-5 °C ... 70 °C
Relative insulation material temperature index (Elec., UL 746 B)	130 °C
Temperature index of insulation material (DIN EN 60216-1 (VDE 0304-21))	125 °C
Static insulating material application in cold	-60 °C
Surface flammability NFPA 130 (ASTM E 162)	passed
Specific optical density of smoke NFPA 130 (ASTM E 662)	passed
Calorimetric heat release NFPA 130 (ASTM E 1354)	27,5 MJ/kg
Smoke gas toxicity NFPA 130 (SMP 800C)	passed
Fire protection for rail vehicles (DIN EN 45545-2) R22	HL 1 - HL 3
Fire protection for rail vehicles (DIN EN 45545-2) R23	HL 1 - HL 3
Fire protection for rail vehicles (DIN EN 45545-2) R24	HL 1 - HL 3
Fire protection for rail vehicles (DIN EN 45545-2) R26	HL 1 - HL 3

Dimensions

Width	60 mm
Length	101 mm
Height NS 35/15	105 mm

Connection data

Connection	1 level
------------	---------

High-current terminal block - PTPOWER 50-3L - 3260053

Technical data

Connection data

Connection method	Power-Turn connection
Stripping length	30 mm ... 32 mm
Connection in acc. with standard	IEC60947-7-1
Conductor cross section solid min.	10 mm ²
Conductor cross section solid max.	70 mm ²
Conductor cross section AWG min.	8
Conductor cross section AWG max.	2/0
Conductor cross section flexible min.	10 mm ²
Conductor cross section flexible max.	70 mm ²
Min. AWG conductor cross section, flexible	8
Max. AWG conductor cross section, flexible	2/0
Conductor cross section flexible, with ferrule without plastic sleeve min.	10 mm ²
Conductor cross section flexible, with ferrule without plastic sleeve max.	50 mm ²
Conductor cross section flexible, with ferrule with plastic sleeve min.	10 mm ²
Conductor cross section flexible, with ferrule with plastic sleeve max.	50 mm ²
Cross section with insertion bridge solid min.	10 mm ²
Cross section with insertion bridge, solid max.	50 mm ²
Cross section with insertion bridge stranded min.	10 mm ²
Cross section with insertion bridge, stranded max.	50 mm ²
Cross section with insertion bridge stranded, with ferrule without plastic sleeve min.	10 mm ²
Cross section with insertion bridge stranded, with ferrule without plastic sleeve max.	50 mm ²
Cross section with insertion bridge stranded, with ferrule without plastic sleeve min.	10 mm ²
Cross section with insertion bridge stranded, with ferrule with plastic sleeve max.	50 mm ²
Connection cross sections directly pluggable	10 mm ² 70 mm ² 8 2/0
Conductor cross section solid min.	10 mm ²
Conductor cross section solid max.	70 mm ²
Conductor cross section flexible, with ferrule without plastic sleeve min.	10 mm ²
Conductor cross section flexible, with ferrule without plastic sleeve max.	50 mm ²
Conductor cross section flexible, with ferrule with plastic sleeve min.	10 mm ²
Conductor cross section flexible, with ferrule with plastic sleeve max.	50 mm ²
Internal cylindrical gage	A10

Standards and Regulations

Connection in acc. with standard	IEC60947-7-1
Flammability rating according to UL 94	V0

High-current terminal block - PTPOWER 50-3L - 3260053

Technical data

Environmental Product Compliance

China RoHS	Environmentally friendly use period: unlimited = EFUP-e
	No hazardous substances above threshold values

Drawings

Circuit diagram



Schematic diagram

PTPOWER

AGK 10-PTPOWER	0,5 mm ² ... 16 mm ²	18 mm
PTPOWER 35	2,5 mm ² ... 35 mm ²	25 mm
PTPOWER 50	0,5 mm ² ... 50 mm ²	32 mm
PTPOWER 95	0,5 mm ² ... 95 mm ²	40 mm
PTPOWER 185	0,5 mm ² ... 185 mm ²	40 mm

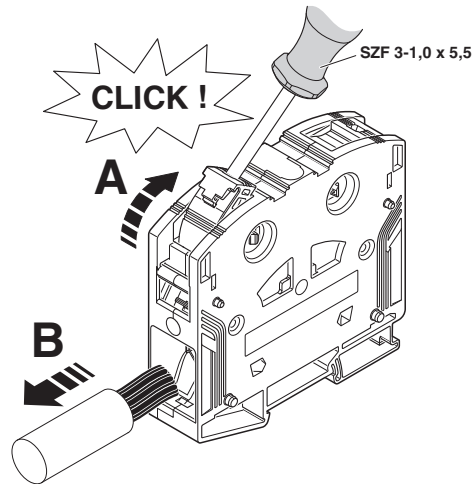

Classifications

eCl@ss

eCl@ss 10.0.1	27141120
eCl@ss 11.0	27141120
eCl@ss 5.0	27141100
eCl@ss 5.1	27141100
eCl@ss 6.0	27141100
eCl@ss 7.0	27141120

High-current terminal block - PTPOWER 50-3L - 3260053

Classifications

eCl@ss

eCl@ss 8.0	27141120
eCl@ss 9.0	27141120

ETIM

ETIM 5.0	EC000897
ETIM 6.0	EC000897
ETIM 7.0	EC000897

UNSPSC

UNSPSC 6.01	30211811
UNSPSC 7.0901	39121410
UNSPSC 11	39121410
UNSPSC 12.01	39121410
UNSPSC 13.2	39121410
UNSPSC 18.0	39121410
UNSPSC 19.0	39121410
UNSPSC 20.0	39121410
UNSPSC 21.0	39121410

Approvals

Approvals

Approvals

DNV GL / CSA / UL Recognized / cUL Recognized / EAC / EAC / cULus Recognized

Ex Approvals

Approval details

DNV GL		https://approvalfinder.dnvgl.com/	TAE00000Z9
--------	--	---	------------

High-current terminal block - PTPOWER 50-3L - 3260053

Approvals

CSA		http://www.csagroup.org/services-industries/product-listing/	13631
	B	C	
Nominal voltage UN	600 V	1000 V	
Nominal current IN	140 A	140 A	
mm ² /AWG/kcmil	8	8	

UL Recognized		http://database.ul.com/cgi-bin/XYV/template/LISEXT/1FRAME/index.htm	FILE E 60425
Nominal voltage UN		1000 V	
Nominal current IN		140 A	
mm ² /AWG/kcmil		8	

cUL Recognized		http://database.ul.com/cgi-bin/XYV/template/LISEXT/1FRAME/index.htm	FILE E 60425
		C	
Nominal voltage UN		1000 V	
Nominal current IN		140 A	
mm ² /AWG/kcmil		8	

EAC			RU C- DE.A*30.B.01742
-----	---	--	--------------------------

EAC			RU C- DE.AI30.B.01102
-----	---	--	--------------------------

cULus Recognized			
------------------	---	--	--

Accessories

Accessories

High-current terminal block - PTPOWER 50-3L - 3260053

Accessories

Cable end sleeve

Ferrule - A 10 -32 - 1090629



Ferrule, length: 32 mm, color: silver

Ferrule - A 16 -32 - 1090633



Ferrule, length: 32 mm, color: silver

Ferrule - A 25 -32 - 1090636



Ferrule, length: 32 mm, color: silver

Ferrule - A 35 -32 - 1090638



Ferrule, length: 32 mm, color: silver

Ferrule - A 50 -32 - 1090639



Ferrule, length: 32 mm, color: silver

High-current terminal block - PTPOWER 50-3L - 3260053

Accessories

Crimping tool

Crimping pliers - CRIMPFOX CENTRUS 10S - 1213154



Crimping pliers, for uninsulated and insulated ferrules, DIN 46228 Part 1 and 4, from 0.14 mm² ... 10 mm², also for TWIN ferrules up to 2 x 4 mm², automatic cross section adjustment, lateral insertion, equipped with fall protection

Crimping pliers - CRIMPFOX CENTRUS 10H - 1213156



Crimping pliers, for uninsulated and insulated ferrules, DIN 46228 Part 1 and 4, from 0.14 mm² ... 10 mm², also for TWIN ferrules up to 2 x 4 mm², automatic cross section adjustment, lateral insertion, equipped with fall protection

Crimping pliers - CRIMPFOX 10S - 1212045



Crimping pliers, for ferrules without insulating collar according to DIN 46228 Part 1 and ferrules with insulating collar according to DIN 46228 Part 4, 0.14 mm² ... 10 mm², unlockable pressure lock, lateral entry

Crimping pliers - CRIMPFOX 10 - 1212721



Crimping pliers, for ferrules without insulating collar according to DIN 46228 Part 1 and ferrules with insulating collar according to DIN 46228 Part 4, 4 mm² ... 10 mm², lateral entry, trapezoidal crimp

Crimping pliers - CRIMPFOX 25R - 1212039



Crimping pliers, for ferrules without insulating collar according to DIN 46228 Part 1 and ferrules with insulating collar according to DIN 46228 Part 4, 10 mm² ... 25 mm², lateral entry, WM crimp

High-current terminal block - PTPOWER 50-3L - 3260053

Accessories

Crimping pliers - CRIMPFOX 50R - 1212041



Crimping pliers, for ferrules without insulating collar according to DIN 46228 Part 1 and ferrules with insulating collar according to DIN 46228 Part 4, 35 mm² ... 50 mm², lateral entry, WM crimp

Crimping pliers - CRIMPFOX-M - 1212072



Basic pliers, for accommodating dies for a wide range of type of contacts

Crimping pliers - CRIMPFOX-C120 - 1212318



Basic pliers, for accommodating dies for a wide range of type of contacts up to 120 mm²

DIN rail

DIN rail perforated - NS 35/15 PERF 2000MM - 1201730



DIN rail perforated, Standard profile, width:35 mm, height:15 mm, similar to EN 60715, material:Steel, galvanized, passivated with a thick layer, length:2000 mm, color:silver

DIN rail, unperforated - NS 35/15 UNPERF 2000MM - 1201714



DIN rail, unperforated, Standard profile, width:35 mm, height:15 mm, similar to EN 60715, material:Steel, galvanized, passivated with a thick layer, length:2000 mm, color:silver

High-current terminal block - PTPOWER 50-3L - 3260053

Accessories

DIN rail perforated - NS 35/15 WH PERF 2000MM - 0806602



DIN rail perforated, Standard profile, width:35 mm, height:15 mm, similar to EN 60715, material:Steel, Galvanized, white passivated, length:2000 mm, color:silver

DIN rail, unperforated - NS 35/15 WH UNPERF 2000MM - 1204135



DIN rail, unperforated, Standard profile, width:35 mm, height:15 mm, similar to EN 60715, material:Steel, Galvanized, white passivated, length:2000 mm, color:silver

DIN rail, unperforated - NS 35/15 AL UNPERF 2000MM - 1201756



DIN rail, unperforated, Standard profile, width:35 mm, height:15 mm, similar to EN 60715, material:Aluminum, uncoated, length:2000 mm, color:silver

DIN rail perforated - NS 35/15 ZN PERF 2000MM - 1206599



DIN rail perforated, Standard profile, width:35 mm, height:15 mm, similar to EN 60715, material:Steel, galvanized, length:2000 mm, color:silver

DIN rail, unperforated - NS 35/15 ZN UNPERF 2000MM - 1206586



DIN rail, unperforated, Standard profile, width:35 mm, height:15 mm, similar to EN 60715, material:Steel, galvanized, length:2000 mm, color:silver

High-current terminal block - PTPOWER 50-3L - 3260053

Accessories

DIN rail, unperforated - NS 35/15 CU UNPERF 2000MM - 1201895



DIN rail, unperforated, Standard profile, width:35 mm, height:15 mm, similar to EN 60715, material:Copper, uncoated, length:2000 mm, color:copper-colored

End cap - NS 35/15 CAP - 1206573



DIN rail end piece, for DIN rail NS 35/15

Documentation

Mounting material - PTPOWER-IL - 1180891



Operating decal for the PTPOWER

End block

End clamp - E/AL-NS 35 - 1201662



End clamp, for end support of UKH 50 to UKH 240, is pushed onto DIN rail NS 35 and fixed with 2 screws, width: 10 mm, color: aluminum

Insertion bridge

High-current terminal block - PTPOWER 50-3L - 3260053

Accessories

Insertion bridge - EB 2-20/PT - 3260067

Insertion bridge, pitch: 20 mm, length: 64.5 mm, width: 35.3 mm, number of positions: 2, color: red



Insertion bridge - EB 3-20/PT - 3260068

Insertion bridge, pitch: 20 mm, length: 64.5 mm, width: 55.3 mm, number of positions: 3, color: red



Insulating sleeve

Insulating sleeve - PS-IH RD - 0311579

Insulating sleeve, color: red



Insulating sleeve - MPS-IH WH - 0201663

Insulating sleeve, color: white



Insulating sleeve - MPS-IH RD - 0201676

Insulating sleeve, color: red



High-current terminal block - PTPOWER 50-3L - 3260053

Accessories

Insulating sleeve - MPS-IH BU - 0201689

Insulating sleeve, color: blue



Insulating sleeve - MPS-IH YE - 0201692

Insulating sleeve, color: yellow



Insulating sleeve - MPS-IH GN - 0201702

Insulating sleeve, color: green



Insulating sleeve - MPS-IH GY - 0201728

Insulating sleeve, color: gray



Insulating sleeve - MPS-IH BK - 0201731

Insulating sleeve, color: black



High-current terminal block - PTPOWER 50-3L - 3260053

Accessories

Insulating sleeve - MPS-IH WH - 0201663

Insulating sleeve, color: white



Insulating sleeve - MPS-IH RD - 0201676

Insulating sleeve, color: red



Insulating sleeve - MPS-IH BU - 0201689

Insulating sleeve, color: blue



Insulating sleeve - MPS-IH YE - 0201692

Insulating sleeve, color: yellow



Insulating sleeve - MPS-IH GN - 0201702

Insulating sleeve, color: green



High-current terminal block - PTPOWER 50-3L - 3260053

Accessories

Insulating sleeve - MPS-IH GY - 0201728

Insulating sleeve, color: gray



Insulating sleeve - MPS-IH BK - 0201731

Insulating sleeve, color: black



Labeled terminal marker

Marker for terminal blocks - TMT 10 R CUS - 0824500



Marker for terminal blocks, can be ordered: by line, white, labeled according to customer specifications, mounting type: snap into universal marker groove, snap into flat marker groove, for terminal block width: 10.2 mm, lettering field size: 6.35 x 10.15 mm

Zack marker strip - ZB 10 CUS - 0824941



Zack marker strip, can be ordered: Strip, white, labeled according to customer specifications, mounting type: snap into tall marker groove, for terminal block width: 10.2 mm, lettering field size: 10.15 x 10.5 mm, Number of individual labels: 10

Zack marker strip - ZB10,LGS:FORTL.ZAHLEN - 1053014



Zack marker strip, Strip, white, labeled, can be labeled with: CMS-P1-PLOTTER, printed horizontally: consecutive numbers 1 ... 10, 11 ... 20, etc. up to 91 ... 100, mounting type: snap into tall marker groove, for terminal block width: 10.2 mm, lettering field size: 10.15 x 10.5 mm, Number of individual labels: 10

High-current terminal block - PTPOWER 50-3L - 3260053

Accessories

Zack marker strip - ZB10,QR:FORTL.ZAHLEN - 1053027



Zack marker strip, Strip, white, labeled, can be labeled with: CMS-P1-PLOTTER, Printed vertically: consecutive numbers 1 ... 10, 11 ... 20, etc. up to 91 ... 100, mounting type: snap into tall marker groove, for terminal block width: 10.2 mm, lettering field size: 10.15 x 10.5 mm, Number of individual labels: 10

Marker for terminal blocks - ZB10,LGS:L1-N,PE - 1053412



Marker for terminal blocks, Strip, white, labeled, can be labeled with: CMS-P1-PLOTTER, horizontal: L1, L2, L3, N, PE, L1, L2, L3, N, PE, mounting type: snap into tall marker groove, for terminal block width: 10.2 mm, lettering field size: 10.15 x 10.5 mm, Number of individual labels: 10

Marker for terminal blocks - ZB10,LGS:U-N - 1053438



Marker for terminal blocks, Strip, white, labeled, can be labeled with: CMS-P1-PLOTTER, horizontal: U, V, W, N, GND, U, V, W, N, GND, mounting type: snap into tall marker groove, for terminal block width: 10.2 mm, lettering field size: 10.15 x 10.5 mm, Number of individual labels: 10

Marker for terminal blocks - UC-TM 10 CUS - 0824605



Marker for terminal blocks, can be ordered: by sheet, white, labeled according to customer specifications, mounting type: snap into tall marker groove, for terminal block width: 10.2 mm, lettering field size: 9.6 x 10.5 mm, Number of individual labels: 48

Marker for terminal blocks - UCT-TM 10 CUS - 0829623



Marker for terminal blocks, can be ordered: by sheet, white, labeled according to customer specifications, mounting type: snap into tall marker groove, for terminal block width: 10.2 mm, lettering field size: 8.9 x 9.6 mm, Number of individual labels: 36

High-current terminal block - PTPOWER 50-3L - 3260053

Accessories

Zack Marker strip, flat - ZBF10 CUS - 0825031



Zack Marker strip, flat, can be ordered: Strip, white, labeled according to customer specifications, mounting type: snap into flat marker groove, for terminal block width: 10 mm, lettering field size: 5.15 x 10 mm, Number of individual labels: 10

Zack Marker strip, flat - ZBF10,LGS:FORTL.ZAHLEN - 0810009



Zack Marker strip, flat, Strip, white, labeled, printed horizontally: consecutive numbers 1 ... 10, 11 ... 20, etc. up to 91 ... 100, mounting type: snap into flat marker groove, for terminal block width: 10 mm, lettering field size: 5.15 x 10 mm, Number of individual labels: 10

Zack Marker strip, flat - ZBF10,QR:FORTL.ZAHLEN - 0810025



Zack Marker strip, flat, Strip, white, labeled, Printed vertically: consecutive numbers 1 ... 10, 11 ... 20, etc. up to 91 ... 100, mounting type: snap into flat marker groove, for terminal block width: 10 mm, lettering field size: 5.15 x 10 mm, Number of individual labels: 10

Marker for terminal blocks - UC-TMF 10 CUS - 0824662



Marker for terminal blocks, can be ordered: by sheet, white, labeled according to customer specifications, mounting type: snap into flat marker groove, for terminal block width: 10.2 mm, lettering field size: 9.6 x 5.1 mm, Number of individual labels: 48

Marker for terminal blocks - UCT-TMF 10 CUS - 0829679



Marker for terminal blocks, can be ordered: by sheet, white, labeled according to customer specifications, mounting type: snap into flat marker groove, for terminal block width: 10.2 mm, lettering field size: 9.4 x 4.7 mm, Number of individual labels: 36

Pick-off terminal block

High-current terminal block - PTPOWER 50-3L - 3260053

Accessories

Pick-off terminal block - AGK 10-PTPOWER - 3260145



Pick-off terminal block, For use with PTPOWER 50, 95, 150, and 185 Power-Turn high-current terminal blocks, nom. voltage: 1500 V, nominal current: 57 A, connection method: Push-in connection, number of connections: 2, cross section: 0.5 mm² - 16 mm², AWG: 20 - 6, width: 18.5 mm, height: 34.7 mm, color: gray, mounting type: on base element

Pick-off terminal block - AGK 10-PTPOWER BU - 3260148



Pick-off terminal block, For use with PTPOWER 50, 95, 150, and 185 Power-Turn high-current terminal blocks, nom. voltage: 1500 V, nominal current: 57 A, connection method: Push-in connection, number of connections: 2, cross section: 0.5 mm² - 16 mm², AWG: 20 - 6, width: 18.5 mm, height: 34.7 mm, color: blue, mounting type: on base element

Pick-off terminal block - AGK 10-PTPOWER GN/YE - 3260151



Pick-off terminal block, For use with PTPOWER 50, 95, 150, and 185 Power-Turn high-current terminal blocks, nom. voltage: 1500 V, nominal current: 57 A, connection method: Push-in connection, number of connections: 2, cross section: 0.5 mm² - 16 mm², AWG: 20 - 6, width: 18.5 mm, height: 34.7 mm, color: green/yellow, mounting type: on base element

Pick-off terminal block - AGK 10-PTPOWER BK/YE - 3260154



Pick-off terminal block, For use with PTPOWER 50, 95, 150, and 185 Power-Turn high-current terminal blocks, nom. voltage: 1500 V, nominal current: 57 A, connection method: Push-in connection, number of connections: 2, cross section: 0.5 mm² - 16 mm², AWG: 20 - 6, width: 18.5 mm, height: 34.7 mm, color: black/yellow, mounting type: on base element

Planning and marking software

Software - CLIP-PROJECT ADVANCED - 5146040



Multilingual software for convenient configuration of Phoenix Contact products on standard DIN rails.

High-current terminal block - PTPOWER 50-3L - 3260053

Accessories

Software - CLIP-PROJECT PROFESSIONAL - 5146053



Multilingual software for terminal strip configuration. A marking module enables the professional marking of markers and labels for identifying terminal blocks, conductors and cables, and devices.

Screwdriver tools

Screwdriver - SZF 3-1,0X5,5 - 1206612



Actuation tool, for ST terminal blocks, also suitable for use as a bladed screwdriver, size: 1.0 x 5.5 x 150 mm, 2-component grip, with non-slip grip

Terminal marking

Marker for terminal blocks - TMT 10 R - 0816210



Marker for terminal blocks. Roll, white, unlabeled, can be labeled with: THERMOMARK ROLL 2.0, THERMOMARK ROLL, THERMOMARK ROLL X1, THERMOMARK ROLLMASTER 300/600, THERMOMARK X1.2, THERMOMARK S1.1, perforated, mounting type: snap into universal marker groove, snap into flat marker groove, for terminal block width: 10.2 mm, lettering field size: 6.35 x 10.15 mm, Number of individual labels: 10000

Zack marker strip - ZB 10:UNBEDRUCKT - 1053001



Zack marker strip. Strip, white, unlabeled, can be labeled with: PLOTMARK, CMS-P1-PLOTTER, mounting type: snap into tall marker groove, for terminal block width: 10.2 mm, lettering field size: 10.5 x 10.15 mm, Number of individual labels: 10

Marker for terminal blocks - UC-TM 10 - 0818069



Marker for terminal blocks. Sheet, white, unlabeled, can be labeled with: BLUEMARKIDCOLOR, BLUEMARKID, BLUEMARK CLED, PLOTMARK, CMS-P1-PLOTTER, mounting type: snap into tall marker groove, for terminal block width: 10.2 mm, lettering field size: 9.6 x 10.5 mm, Number of individual labels: 48

High-current terminal block - PTPOWER 50-3L - 3260053

Accessories

Marker for terminal blocks - UCT-TM 10 - 0829142



Marker for terminal blocks, Sheet, white, unlabeled, can be labeled with: TOPMARKNEO, TOPMARK LASER, BLUEMARKIDCOLOR, BLUEMARKID, BLUEMARK CLED, THERMOMARK PRIME, THERMOMARK CARD 2.0, THERMOMARK CARD, mounting type: snap into tall marker groove, for terminal block width: 10.2 mm, lettering field size: 8.9 x 9.6 mm, Number of individual labels: 36

Zack Marker strip, flat - ZBF10:UNBEDRUCKT - 0809997



Zack Marker strip, flat, Strip, white, unlabeled, can be labeled with: CMS-P1-PLOTTER, PLOTMARK, mounting type: snap into flat marker groove, for terminal block width: 10 mm, lettering field size: 5.15 x 10 mm, Number of individual labels: 10

Marker for terminal blocks - UC-TMF 10 - 0818124



Marker for terminal blocks, Sheet, white, unlabeled, can be labeled with: BLUEMARKIDCOLOR, BLUEMARKID, BLUEMARK CLED, PLOTMARK, CMS-P1-PLOTTER, mounting type: snap into flat marker groove, for terminal block width: 10.2 mm, lettering field size: 9.6 x 5.1 mm, Number of individual labels: 48

Marker for terminal blocks - UCT-TMF 10 - 0829204



Marker for terminal blocks, Sheet, white, unlabeled, can be labeled with: TOPMARKNEO, TOPMARK LASER, BLUEMARKIDCOLOR, BLUEMARKID, BLUEMARK CLED, THERMOMARK PRIME, THERMOMARK CARD 2.0, THERMOMARK CARD, mounting type: snap into flat marker groove, for terminal block width: 10.2 mm, lettering field size: 9.4 x 4.7 mm, Number of individual labels: 36

Test plug terminal block

Test plugs - PS-MT - 0311647



Test plugs, color: silver

High-current terminal block - PTPOWER 50-3L - 3260053

Accessories

Test plugs - MPS-MT - 0201744



Test plugs, with solder connection up to 1 mm² conductor cross section, color: gray

Test plugs - MPS-MT/ 4MM - 3048577



Test plugs, with solder connection up to 1 mm² conductor cross section, color: silver

Warning label printed

Cover - CEC PTPOWER 35/50 - 1056086



Cover, yellow, labeled: Lightning flash, mounting type: plug in
