

Features

- Zener Voltages from 2.4 - 39V
- Three Isolated Diode Elements in a Single Ultra-Small Surface Mount Package
- **Lead Free/RoHS Compliant (Note 2)**
- **"Green" Device (Note 3 and 4)**



Top View

Mechanical Data

- Case: SOT-363
- Case Material: Molded Plastic. UL Flammability Classification Rating 94V-0
- Moisture Sensitivity: Level 1 per J-STD-020D
- Terminals: Solderable per MIL-STD-202, Method 208
- Lead Free Plating (Matte Tin Finish annealed over Alloy 42 leadframe).
- Orientation: See Diagram
- Marking Information: See Page 3
- Ordering Information: See Page 3
- Weight: 0.006 grams (approximate)

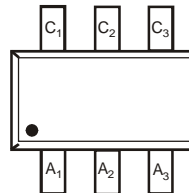

Package Pin Out Configuration

Maximum Ratings @ $T_A = 25^\circ\text{C}$ unless otherwise specified

| Characteristic | Symbol | Value | Unit |
|---------------------------------------|--------|-------|------|
| Forward Voltage @ $I_F = 10\text{mA}$ | V_F | 0.9 | V |

Thermal Characteristics

| Characteristic | Symbol | Value | Unit |
|--|-----------------|-------------|--------------------|
| Power Dissipation (Note 1) | P_D | 200 | mW |
| Thermal Resistance, Junction to Ambient Air (Note 1) | $R_{\theta JA}$ | 625 | $^\circ\text{C/W}$ |
| Operating and Storage Temperature Range | T_J, T_{STG} | -65 to +150 | $^\circ\text{C}$ |

- Notes:
1. Mounted on FR4 PC Board with recommended pad layout which can be found on our website at <http://www.diodes.com/datasheets/ap02001.pdf>.
 2. No purposefully added lead.
 3. Diodes Inc.'s "Green" policy can be found on our website at http://www.diodes.com/products/lead_free/index.php.
 4. Product manufactured with Date Code UO (week 40, 2007) and newer are built with Green Molding Compound. Product manufactured prior to Date Code UO are built with Non-Green Molding Compound and may contain Halogens or Sb2O3 Fire Retardants.

Electrical Characteristics @T_A = 25°C unless otherwise specified

| Type Number | Marking Code | Zener Voltage Range (Note 5) | | | | Maximum Zener Impedance (Note 6) | | | Maximum Reverse Current (Note 5) | | Temperature Coefficient of Zener Voltage @ I _{ZT} = 5mA mV/°C | |
|-------------|--------------|----------------------------------|---------|---------|-----------------|-----------------------------------|-----------------------------------|-----------------|----------------------------------|----------------|--|------|
| | | V _Z @ I _{ZT} | | | I _{ZT} | Z _{ZT} @ I _{ZT} | Z _{ZK} @ I _{ZK} | I _{ZK} | I _R | V _R | Min | Max |
| | | Nom (V) | Min (V) | Max (V) | mA | Ω | | mA | uA | @ V | | |
| BZX84C2V4TS | KRB | 2.4 | 2.2 | 2.6 | 5 | 100 | 600 | 0.5 | 50 | 1.0 | -3.5 | 0 |
| BZX84C2V7TS | KRC | 2.7 | 2.5 | 2.9 | 5 | 100 | 600 | 1.0 | 20 | 1.0 | -3.5 | 0 |
| BZX84C3V0TS | KRD | 3.0 | 2.8 | 3.2 | 5 | 95 | 600 | 1.0 | 10 | 1.0 | -3.5 | 0 |
| BZX84C3V3TS | KRE | 3.3 | 3.1 | 3.5 | 5 | 95 | 600 | 1.0 | 5.0 | 1.0 | -3.5 | 0 |
| BZX84C3V6TS | KRF | 3.6 | 3.4 | 3.8 | 5 | 90 | 600 | 1.0 | 5.0 | 1.0 | -3.5 | 0 |
| BZX84C3V9TS | KRG | 3.9 | 3.7 | 4.1 | 5 | 90 | 600 | 1.0 | 3.0 | 1.0 | -3.5 | 0 |
| BZX84C4V3TS | KRH | 4.3 | 4.0 | 4.6 | 5 | 90 | 600 | 1.0 | 3.0 | 1.0 | -3.5 | 0 |
| BZX84C4V7TS | KR1 | 4.7 | 4.4 | 5.0 | 5 | 80 | 500 | 1.0 | 3.0 | 2.0 | -3.5 | 0.2 |
| BZX84C5V1TS | KR2 | 5.1 | 4.8 | 5.4 | 5 | 60 | 480 | 1.0 | 2.0 | 2.0 | -2.7 | 1.2 |
| BZX84C5V6TS | KR3 | 5.6 | 5.2 | 6.0 | 5 | 40 | 400 | 1.0 | 1.0 | 2.0 | -2.0 | 2.5 |
| BZX84C6V2TS | KR4 | 6.2 | 5.8 | 6.6 | 5 | 10 | 150 | 1.0 | 3.0 | 4.0 | 0.4 | 3.7 |
| BZX84C6V8TS | KR5 | 6.8 | 6.4 | 7.2 | 5 | 15 | 80 | 1.0 | 2.0 | 4.0 | 1.2 | 4.5 |
| BZX84C7V5TS | KR6 | 7.5 | 7.0 | 7.9 | 5 | 15 | 80 | 1.0 | 1.0 | 5.0 | 2.5 | 5.3 |
| BZX84C8V2TS | KR7 | 8.2 | 7.7 | 8.7 | 5 | 15 | 80 | 1.0 | 0.7 | 5.0 | 3.2 | 6.2 |
| BZX84C9V1TS | KR8 | 9.1 | 8.5 | 9.6 | 5 | 15 | 100 | 1.0 | 0.5 | 6.0 | 3.8 | 7.0 |
| BZX84C10TS | KR9 | 10.0 | 9.4 | 10.6 | 5 | 20 | 150 | 1.0 | 0.2 | 7.0 | 4.5 | 8.0 |
| BZX84C11TS | KP1 | 11.0 | 10.4 | 11.6 | 5 | 20 | 150 | 1.0 | 0.1 | 8.0 | 5.4 | 9.0 |
| BZX84C12TS | KP2 | 12.0 | 11.4 | 12.7 | 5 | 25 | 150 | 1.0 | 0.1 | 8.0 | 6.0 | 10.0 |
| BZX84C13TS | KP3 | 13.0 | 12.4 | 14.1 | 5 | 30 | 170 | 1.0 | 0.1 | 8.0 | 7.0 | 11.0 |
| BZX84C15TS | KP4 | 15.0 | 13.8 | 15.6 | 5 | 30 | 200 | 1.0 | 0.1 | 10.5 | 9.2 | 13.0 |
| BZX84C16TS | KP5 | 16.0 | 15.3 | 17.1 | 5 | 40 | 200 | 1.0 | 0.1 | 11.2 | 10.4 | 14.0 |
| BZX84C18TS | KP6 | 18.0 | 16.8 | 19.1 | 5 | 45 | 225 | 1.0 | 0.1 | 12.6 | 12.4 | 16.0 |
| BZX84C20TS | KP7 | 20.0 | 18.8 | 21.2 | 5 | 55 | 225 | 1.0 | 0.1 | 14.0 | 14.4 | 18.0 |
| BZX84C22TS | KP8 | 22.0 | 20.8 | 23.3 | 5 | 55 | 250 | 1.0 | 0.1 | 15.4 | 16.4 | 20.0 |
| BZX84C24TS | KP9 | 24.0 | 22.8 | 25.6 | 5 | 70 | 250 | 1.0 | 0.1 | 16.8 | 18.4 | 22.0 |
| BZX84C27TS | KPA | 27.0 | 25.1 | 28.9 | 2 | 80 | 300 | 0.5 | 0.1 | 18.9 | 21.4 | 25.3 |
| BZX84C30TS | KPB | 30.0 | 28.0 | 32.0 | 2 | 80 | 300 | 0.5 | 0.1 | 21.0 | 24.4 | 29.4 |
| BZX84C33TS | KPC | 33.0 | 31.0 | 35.0 | 2 | 80 | 325 | 0.5 | 0.1 | 23.1 | 27.4 | 33.4 |
| BZX84C36TS | KPD | 36.0 | 34.0 | 38.0 | 2 | 90 | 350 | 0.5 | 0.1 | 25.2 | 30.4 | 37.4 |
| BZX84C39TS | KPE | 39.0 | 37.0 | 41.0 | 2 | 130 | 350 | 0.5 | 0.1 | 27.3 | 33.4 | 41.2 |

Notes: 5. Short duration pulse test used to minimize self-heating effect.
6. f = 1KHz.

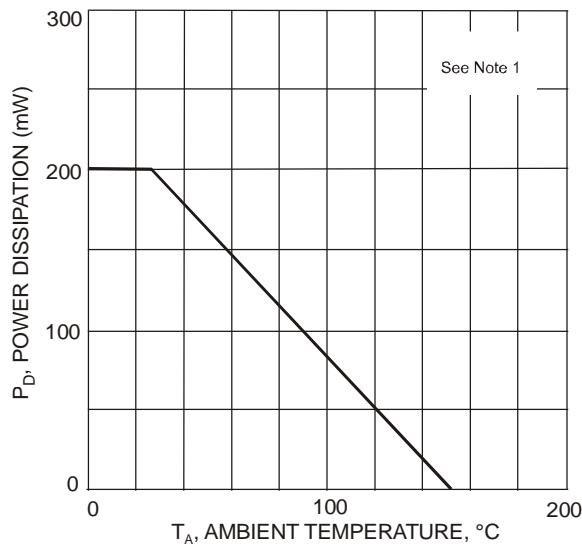

Fig. 1. Power Derating Curve

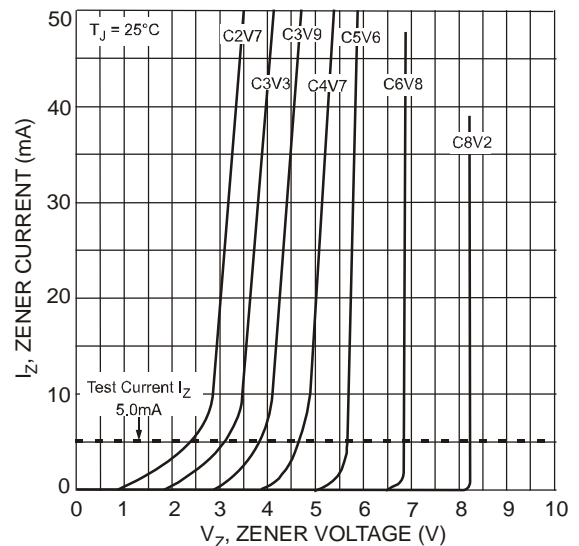

Fig. 2. Typical Zener Breakdown Characteristics

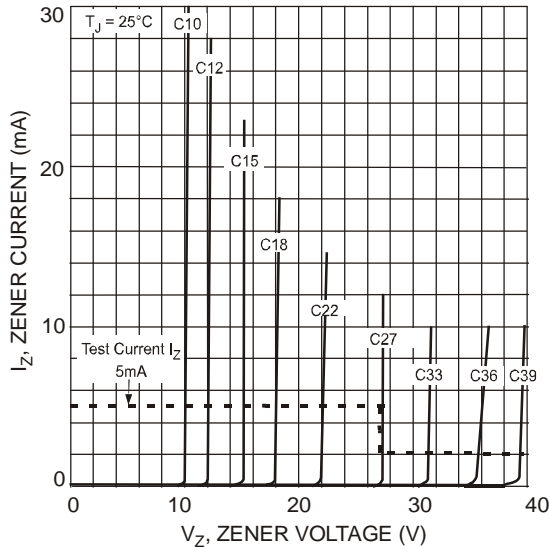

Fig. 3. Typical Zener Breakdown Characteristics

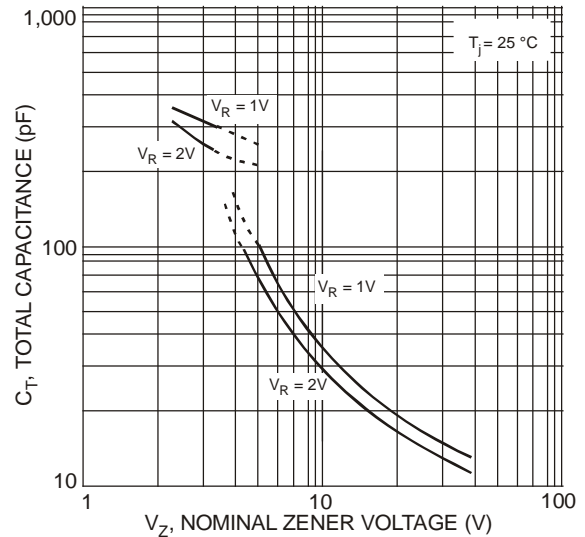

Fig. 4. Typical Total Capacitance vs. Nominal Zener Voltage

Ordering Information (Note 7)

| Part Number | Case | Packaging |
|--------------------|---------|------------------|
| (Type Number)-7-F* | SOT-363 | 3000/Tape & Reel |

*Add "-7-F" to the appropriate type number in Electrical Characteristics Table on Page 2 example: 6.2V Zener = BZX84C6V2TS-7-F.

Notes: 7. For packaging details, go to our website at <http://www.diodes.com/datasheets/ap02007.pdf>.

Marking Information

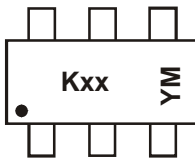

Kxx = Product Type Marking Code
(See Electrical Characteristics Table)
YM = Date Code Marking
Y = Year (ex: N = 2002)
M = Month (ex: 9 = September)

Date Code Key

| Year | 2002 | 2003 | 2004 | 2005 | 2006 | 2007 | 2008 | 2009 | 2010 | 2011 | 2012 |
|------|------|------|------|------|------|------|------|------|------|------|------|
| Code | N | P | R | S | T | U | V | W | X | Y | Z |

| Month | Jan | Feb | Mar | Apr | May | Jun | Jul | Aug | Sep | Oct | Nov | Dec |
|-------|-----|-----|-----|-----|-----|-----|-----|-----|-----|-----|-----|-----|
| Code | 1 | 2 | 3 | 4 | 5 | 6 | 7 | 8 | 9 | O | N | D |

Package Outline Dimensions

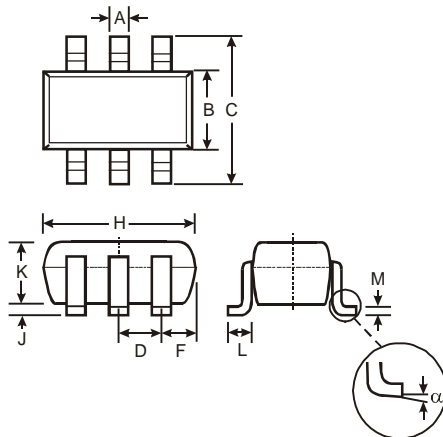

| SOT-363 | | |
|----------------------|--------------|------|
| Dim | Min | Max |
| A | 0.10 | 0.30 |
| B | 1.15 | 1.35 |
| C | 2.00 | 2.20 |
| D | 0.65 Nominal | |
| F | 0.40 | 0.45 |
| H | 1.80 | 2.20 |
| J | 0 | 0.10 |
| K | 0.90 | 1.00 |
| L | 0.25 | 0.40 |
| M | 0.10 | 0.22 |
| α | 0° | 8° |
| All Dimensions in mm | | |

Suggested Pad Layout

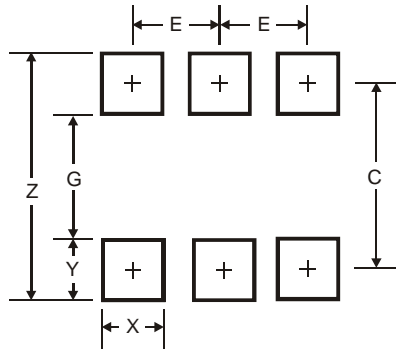

| Dimensions | Value (in mm) |
|------------|---------------|
| Z | 2.5 |
| G | 1.3 |
| X | 0.42 |
| Y | 0.6 |
| C | 1.9 |
| E | 0.65 |

IMPORTANT NOTICE

Diodes Incorporated and its subsidiaries reserve the right to make modifications, enhancements, improvements, corrections or other changes without further notice to any product herein. Diodes Incorporated does not assume any liability arising out of the application or use of any product described herein; neither does it convey any license under its patent rights, nor the rights of others. The user of products in such applications shall assume all risks of such use and will agree to hold Diodes Incorporated and all the companies whose products are represented on our website, harmless against all damages.

LIFE SUPPORT

Diodes Incorporated products are not authorized for use as critical components in life support devices or systems without the expressed written approval of the President of Diodes Incorporated.