

2N6050, 2N6051, 2N6052, 2N6057, 2N6058, 2N6059

File Number 1185

12-Ampere Complementary P-N-P and N-P-N Monolithic Darlington Power Transistors

60-80-100 Volts, 150 Watts
 Gain of 7000 (Typ.) at 5 A (2N6050, 2N6051, 2N6052)
 Gain of 4000 (Typ.) at 5 A (2N6057, 2N6058, 2N6059)

Features:

- Operates from IC without predriver
- Monolithic construction
- High voltage ratings:

$V_{CEO(sus)}$ = 60 V Min. — 2N6050*, 2N6057
 = 80 V Min. — 2N6051*, 2N6058
 = 100 V Min. — 2N6052*, 2N6059

TERMINAL DESIGNATIONS

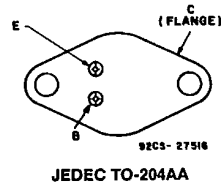

The RCA-2N6050, 2N6051, and 2N6052 p-n-p types and the 2N6057, 2N6058, and 2N6059 n-p-n types are complementary monolithic silicon Darlington transistors designed for general-purpose amplifier and low-speed switching applications. The high gain of these devices makes it possible for them to be driven directly from integrated circuits. These devices are supplied in the JEDEC TO-204AA hermetic steel package.

Applications:

- Power switching
- Hammer drivers
- Series and shunt regulators
- Audio amplifiers

MAXIMUM RATINGS, Absolute-Maximum Values:

	2N6050* 2N6057	2N6051* 2N6058	2N6052* 2N6059	
* V_{CBO}	60	80	100	V
* $V_{CEO(sus)}$	60	80	100	V
* V_{EBO}		5		V
* I_C		12		A
* I_{CM}		20		A
* I_B		0.2		A
* P_T		150		W
$T_C \leq 25^\circ C$				$W/^\circ C$
$T_C > 25^\circ C$	Derate linearly			
* T_{stg}, T_J		-65 to 200		$^\circ C$
* T_L		235		$^\circ C$
At distances $\geq 1/16$ in. (1.58 mm) from case for 10 s max.				

* In accordance with JEDEC registration data. • For p-n-p devices, voltage and current values are negative.

2N6050, 2N6051, 2N6052, 2N6057, 2N6058, 2N6059

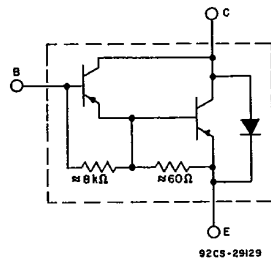

Fig. 1 - Schematic diagram for 2N6050, 2N6051, and 2N6052.

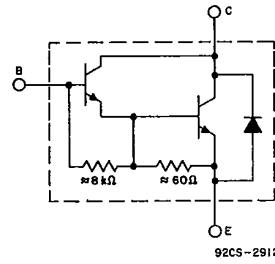

Fig. 2 - Schematic diagram for 2N6057, 2N6058, and 2N6059.

ELECTRICAL CHARACTERISTICS, at Case Temperature (T_C) = 25°C Unless Otherwise Specified

CHARACTERISTIC	TEST CONDITIONS				LIMITS					UNITS	
	VOLTAGE V dc		CURRENT A dc		2N6050* 2N6057		2N6051* 2N6058		2N6052* 2N6059		
	V_{CE}	V_{BE}	I_C	I_B	MIN.	MAX.	MIN.	MAX.	MIN.		MAX.
* I_{CEO}	30			0	-	1	-	-	-	-	mA
	40			0	-	-	-	1	-	-	
	50			0	-	-	-	-	-	1	
* I_{CEX}	60	-1.5			-	0.5	-	-	-	-	mA
	80	-1.5			-	-	-	0.5	-	-	
	100	-1.5			-	-	-	-	-	0.5	
$T_C = 150^\circ C$	60	-1.5			-	5	-	-	-	-	mA
	80	-1.5			-	-	-	5	-	-	
	100	-1.5			-	-	-	-	-	5	
* I_{EBO}		-5	0		-	2	-	2	-	2	mA
* $V_{CEO}(sus)$			0.1 ^a	0	60	-	80	-	100	-	V
* h_{FE}	3		12 ^a		100	-	100	-	100	-	
	3		6 ^a		750	18,000	750	18,000	750	18,000	
* $V_{CE}(sat)$			12 ^a	0.12	-	3	-	3	-	3	V
			6 ^a	0.024	-	2	-	2	-	2	
* V_{BE}	3		6 ^a		-	2.8	-	2.8	-	2.8	V
* $V_{BE}(sat)$			12 ^a	0.12	-	4	-	4	-	4	V
* h_{fe} f = 1 kHz	3		5		300	-	300	-	300	-	
* $ h_{fe} $ f = 1 MHz	3		5		4	-	4	-	4	-	
* C_{ob} $V_{CB} = 10 V, I_E = 0,$ f = 0.1 MHz											pF
2N6050-52					-	500	-	500	-	500	
2N6057-59					-	300	-	300	-	300	
I_S/b t = 1 s, nonrep.	30				5	-	5	-	5	-	A
$R_{\theta JC}$						1.17	-	1.17	-	1.17	°C/W

^a Pulsed: Pulse duration = 300 μs, duty factor = 1.8%. * For p-n-p devices, voltage and current values are negative.
* In accordance with JEDEC registration data.

2N6050, 2N6051, 2N6052, 2N6057, 2N6058, 2N6059

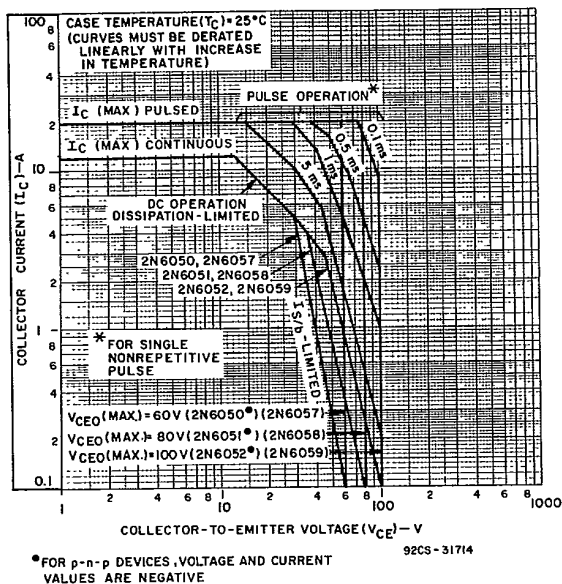

Fig. 3 - Maximum operating areas for all types.

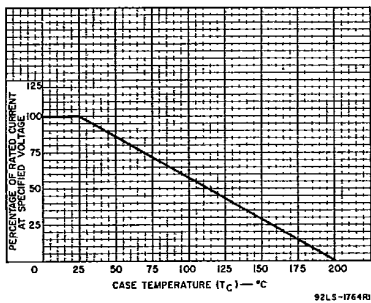

Fig. 4 - Current derating curve for all types.

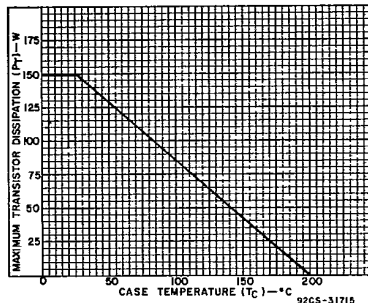

Fig. 5 - Power derating curve for all types.

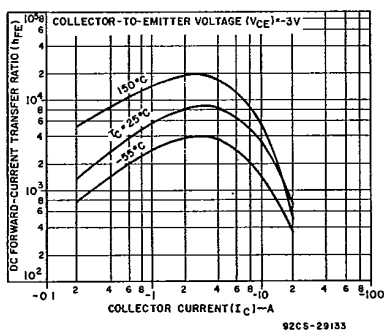

Fig. 6 - Typical dc beta characteristics for 2N6050, 2N6051, and 2N6052.

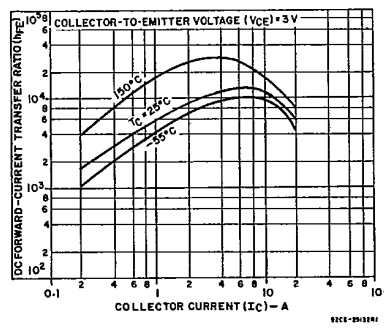
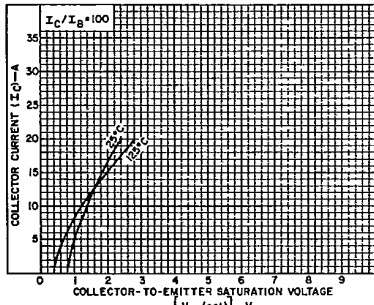

Fig. 7 - Typical dc beta characteristics for 2N6057, 2N6058, and 2N6059.

2N6050, 2N6051, 2N6052, 2N6057, 2N6058, 2N6059



FOR p-n-p DEVICES, VOLTAGE AND CURRENT VALUES ARE NEGATIVE
92CS-31712

Fig. 8 - Typical saturation characteristics for all types.

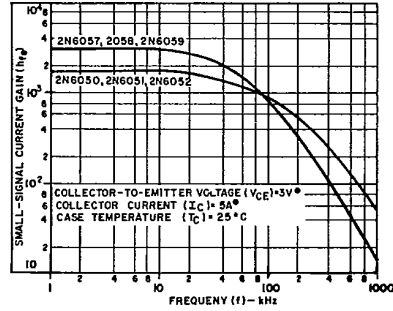

FOR p-n-p DEVICES, VOLTAGE AND CURRENT VALUES ARE NEGATIVE
92CS-31713

Fig. 9 - Typical small-signal current gain for all types.

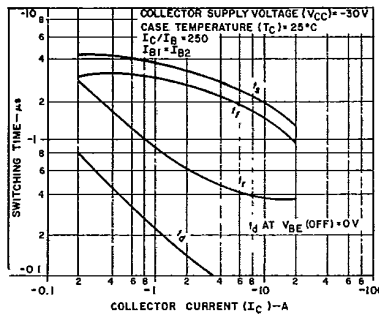

92CS-29137

Fig. 10 - Typical switching times for 2N6050, 2N6051, and 2N6052.

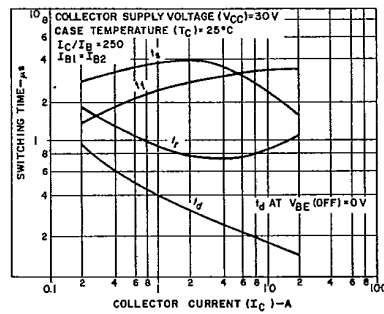

92CS-29138

Fig. 11 - Typical switching times for 2N6057, 2N6058, and 2N6059.

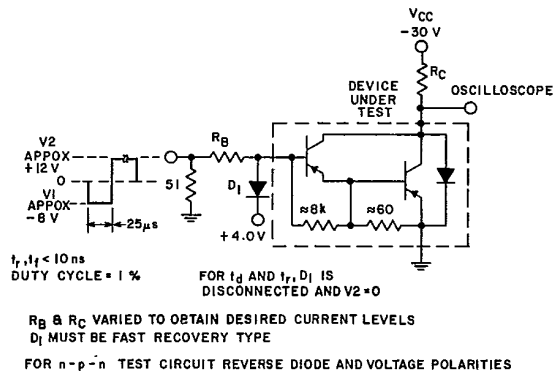

92CS-29138

Fig. 12 - Switching times test circuit.