

DO NOT SCALE FROM THIS PRINT

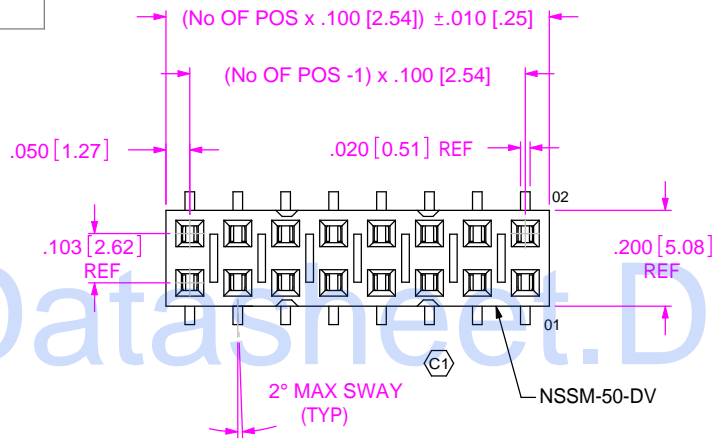

No OF POSITIONS
 -02 THRU -40
 (PER ROW) (SEE NOTE 7)

- AC PLATING**
- S: 30µ" SELECTIVE GOLD IN CONTACT AREA MATTE TIN ON TAIL
 - L: 10µ" LIGHT SELECTIVE GOLD IN CONTACT AREA MATTE TIN ON TAIL
 - T: MATTE TIN CONTACT AND TAIL
 - F: 3µ" FLASH SELECTIVE GOLD CONTACT, MATTE TIN ON TAIL
 - H: 30µ" HEAVY GOLD IN CONTACT AREA 3µ" ON TAIL
 - STL: 30µ" SELECTIVE GOLD IN CONTACT AREA TIN/LEAD (90/10+/-5%) TAIL
 - SM: 30µ" SELECTIVE GOLD IN CONTACT AREA MATTE TIN ON TAIL
 - LM: 10µ" LIGHT SELECTIVE GOLD IN CONTACT AREA MATTE TIN TAIL
 - TM: MATTE TIN CONTACT AND TAIL
 - FM: 3µ" FLASH SELECTIVE GOLD IN CONTACT AREA MATTE TIN TAIL

- OPTION**
- A: ALIGNMENT PIN (SEE FIG 3, SHT 2) (MOLDED: USE NSSM-XX-DV-XX, 4 POS MIN)
 - P: PICK & PLACE PAD (SEE NOTE 5) (USE PPP-01, SEE FIG 4, SHT 2)
 - M: METAL PICK & PLACE PAD (SEE NOTE 5) (USE LMP-02, SEE FIG 5, SHT 2)
 - K: POLYIMIDE FILM PAD (POS 2 THROUGH 40 - SEE NOTE 5) (USE K-500-300, SEE FIG 6, SHT 2)
 - TR: TAPE & REEL (SEE FIG 8, SHT 2-29 POSITIONS MAX)

- OPTION**
- BE: BOTTOM ENTRY (ONLY AVAILABLE ON -DV) (FOR -DV SEE NSSM-50-DV-XX)

- POLARIZING OPTION**
- XX: POSITION TO BE POLARIZED (USE PK-06-N) (SEE FIG 7, SHT 2) (NOT AVAILABLE WITH -BE OPTION)

- MOUNTING OPTION**
- LC: LOCKING CLIP (USE LC-05-TM)(SEE FIG 2)(SEE NOTE 8)

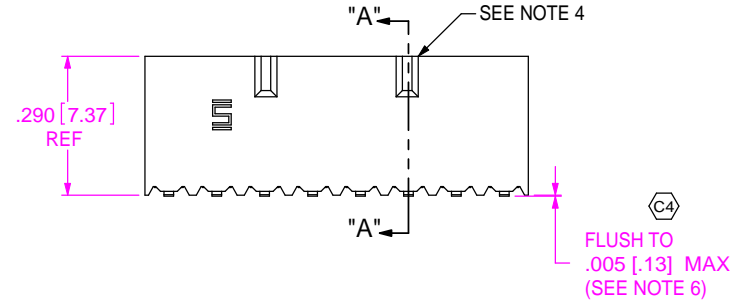

ROW SPECIFICATION

- DV: DOUBLE VERTICAL (USE NSSM-XX-DV-XX)

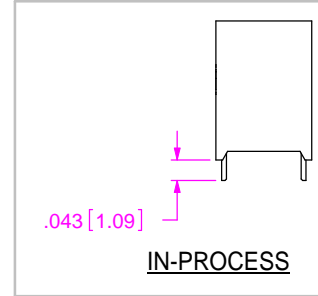
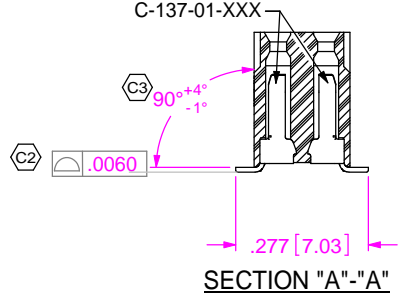

- NOTES:**
- ① REPRESENTS A CRITICAL DIMENSION.
 - PULLOUT FORCE TO BE: 1 lb MIN.
 - MAXIMUM CUT FLASH: .010.
 - CUT PARTS MAY OR MAY NOT HAVE NOTCHES
 - P OPTION: 4 POSITION AND UNDER TO BE -T/R
 -M OPTION: 3 POSITION AND UNDER TO BE -T/R
 -K OPTION: 3 POSITION AND UNDER TO BE -T/R
 ALL OTHER POSITIONS WITH -P, -M, -K OPTIONS ARE TO BE TUBED, UNLESS -TR ORDERED BY CUSTOMER.
 - FLUSH DIMENSION MUST BE INSPECTED ON BOTH ROWS OF ASSEMBLY.
 - 40 MAX POSITION AVAILABLE, -50 FOR STOCK ONLY
 - DUE TO THE HIGH AMOUNT OF INSERTION FORCE NEEDED, THE -LC OPTION IS NOT COMPATIBLE WITH AUTO PLACEMENT. SAMTEC RECOMMENDS MANUAL PLACEMENT FOR ALL ASSEMBLIES WITH THE -LC OPTION.

FIGURE 2

-LC: LOCKING CLIP OPTION

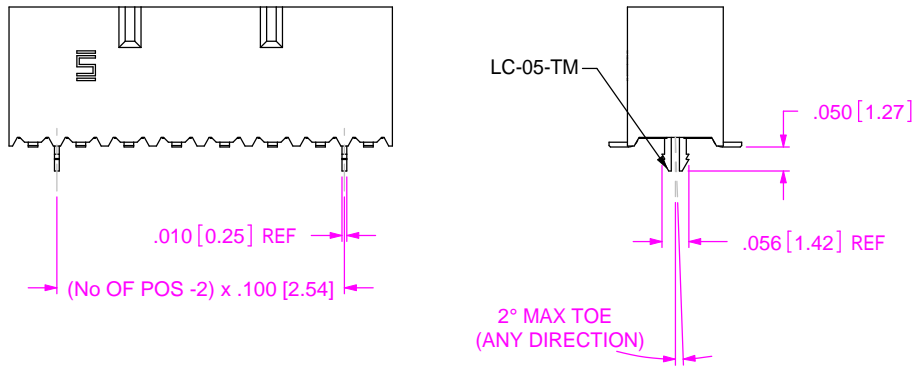

UNLESS OTHERWISE SPECIFIED, DIMENSIONS ARE IN INCHES.
 TOLERANCES ARE:
 DECIMALS ANGLES
 .XX: ±.01 [.3] 2°
 .XXX: ±.005 [.13]
 .XXXX: ±.0020 [.051]

PROPRIETARY NOTE
 THIS DOCUMENT CONTAINS INFORMATION CONFIDENTIAL AND PROPRIETARY TO SAMTEC, INC. AND SHALL NOT BE REPRODUCED OR TRANSFERRED TO OTHER DOCUMENTS OR DISCLOSED TO OTHERS OR USED FOR ANY PURPOSE OTHER THAN THAT WHICH IT WAS OBTAINED WITHOUT THE EXPRESSED WRITTEN CONSENT OF SAMTEC, INC.

samtec
 520 PARK EAST BLVD, NEW ALBANY, IN 47150
 PHONE 812-944-6733 FAX: 812-948-5047
 e-Mail info@SAMTEC.com code 55322

MATERIAL: DO NOT SCALE DRAWING SHEET SCALE 1:0.4
BODY: VECTRA E130i, LCP UL 94 V0
CONTACT: PHOS BRONZE

DESCRIPTION: .100 C.L. DOUBLE VERTICAL SMT SOCKET STRIP
DWG. NO. SSM-1XX-XXX-DV-XX-XX-X-XX

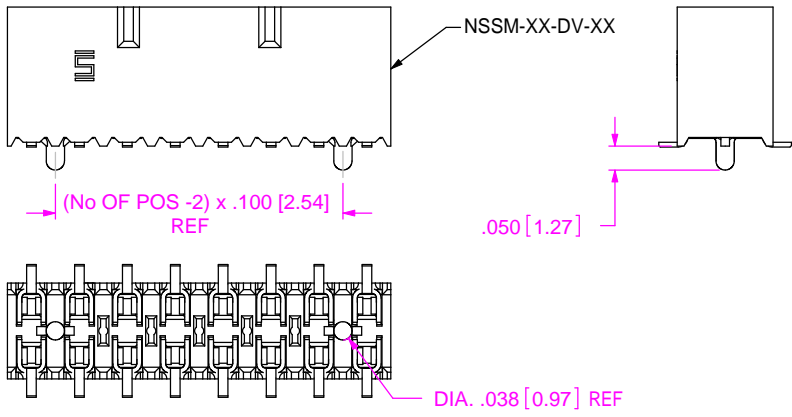
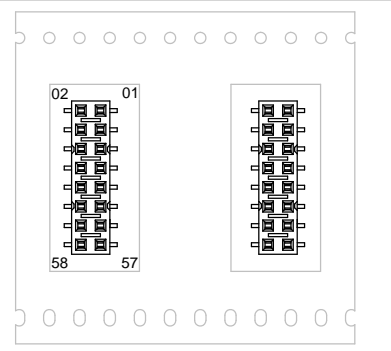

FIGURE 3
-A: ALIGNMENT PIN
MOLDED (4 POSITION MIN)

FIGURE 8
TAPE & REEL VIEW



USER DIRECTION OF UNREELING
POCKET NOT DETAILED

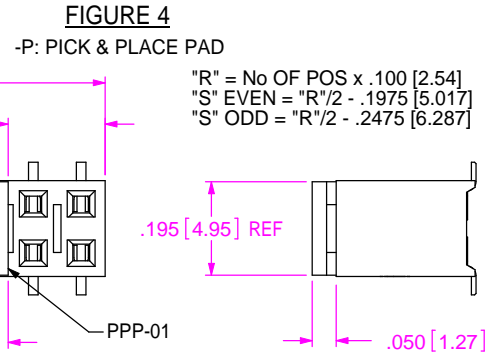

FIGURE 4
-P: PICK & PLACE PAD

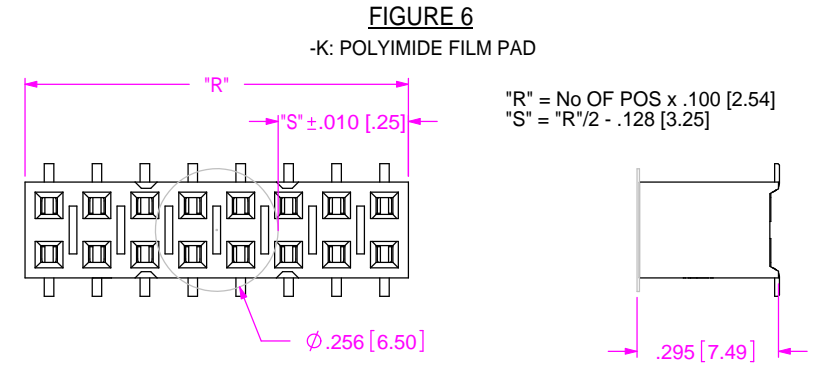

FIGURE 6
-K: POLYIMIDE FILM PAD

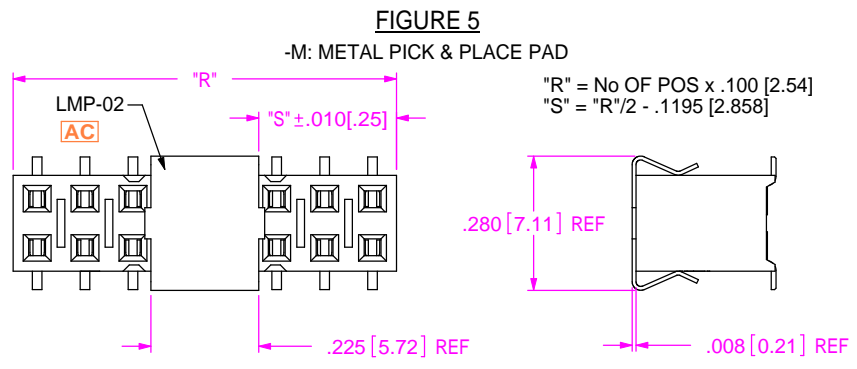

FIGURE 5
-M: METAL PICK & PLACE PAD

TABLE 1			
OPTION	PACKAGING TUBE	PLUG	POSITIONS ALLOWED
-K, -M -LC-K, -LC-M, -A-K,	PT-1-24-01-103	TP-09	02 THRU 40
NONE, -LC, -A, -P-LC, -P	PT-1-24-03-15	TP-03	02 THRU 40

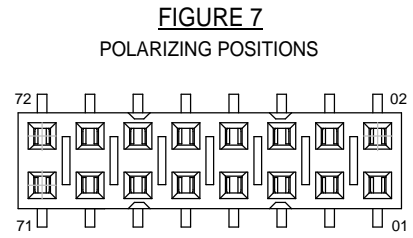
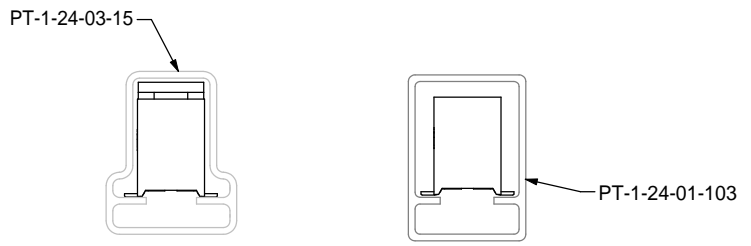

FIGURE 7
POLARIZING POSITIONS

PROPRIETARY NOTE
THIS DOCUMENT CONTAINS INFORMATION CONFIDENTIAL AND PROPRIETARY TO SAMTEC, INC. AND SHALL NOT BE REPRODUCED OR TRANSFERRED TO OTHER DOCUMENTS OR DISCLOSED TO OTHERS OR USED FOR ANY PURPOSE OTHER THAN THAT WHICH IT WAS OBTAINED WITHOUT THE EXPRESSED WRITTEN CONSENT OF SAMTEC, INC.

DO NOT SCALE DRAWING

SHEET SCALE: 1:0.4

samtec
520 PARK EAST BLVD, NEW ALBANY, IN 47150
PHONE 812-944-6733 FAX: 812-948-5047
e-Mail info@SAMTEC.com code 55322

DESCRIPTION:
.100 C.L. DOUBLE VERTICAL SMT SOCKET STRIP

DWG. NO.
SSM-1XX-XXX-DV-XX-XX-X-XX

BY: KEVIN B 3/8/2000 SHEET 2 OF 2