

MICRO POWER STEP-UP DC-DC CONVERTER
AP3015/A
General Description

The AP3015/A are Pulse Frequency Modulation (PFM) DC/DC converters. These two devices are functionally equivalent except the switching current limit. The AP3015 is designed for higher power systems with 350mA current limit, and the AP3015A is for lower power systems with 100mA current limit.

The AP3015/A feature a wide input voltage. The operation voltage is ranged from 1.2V to 12V (1V to 12V for AP3015A). A current limited, fixed off-time control scheme conserves operating current, resulting in high efficiency over a broad range of load current. They also feature low quiescent current, switching current limiting, low temperature coefficient, etc.

Fewer tiny external components are required in the applications to save space and lower cost. Furthermore, to ease its use in different systems, a disable terminal is designed to turn on or turn off the chip.

The AP3015/A are available in SOT-23-5 package.

Features

- Low Quiescent Current
In Active Mode (Not Switching): 17 μ A Typical
In Shutdown Mode: <1 μ A
- Low Operating V_{IN}
1.2V Typical for AP3015
1.0V Typical for AP3015A
- Low V_{CESAT} Switch
200mV Typical at 300mA for AP3015
70mV Typical at 70mA for AP3015A
- High Output Voltage: up to 34V
- Fixed Off-Time Control
- Switching Current Limiting
350mA Typical for AP3015
100mA Typical for AP3015A
- Operating Temperature Range: -40°C to 85°C

Applications

- MP3, MP4
- Battery Power Supply System
- LCD/OLED Bias Supply
- Handheld Device
- Portable Communication Device

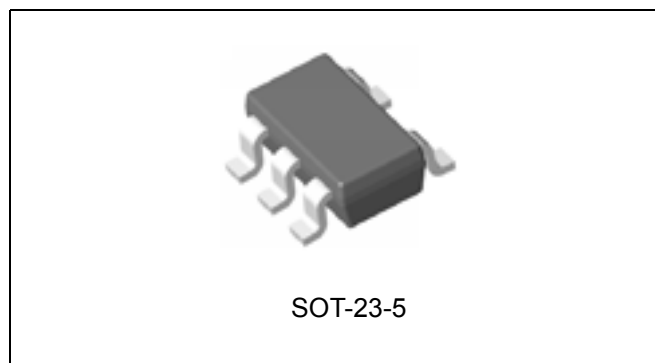


Figure 1. Package Type of AP3015/A

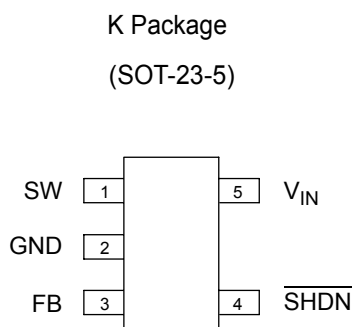
MICRO POWER STEP-UP DC-DC CONVERTER
AP3015/A
Pin Configuration


Figure 2. Pin Configuration of AP3015/A (Top View)

Pin Description

Pin Number	Pin Name	Function
1	SW	Switch Pin. This is the collector of the internal NPN power switch. Minimize the trace area connected to this Pin to minimize EMI
2	GND	Ground Pin. GND should be tied directly to ground plane for best performance
3	FB	Feedback Pin. Set the output voltage through this pin. The formula is $V_{OUT}=1.23V*(1+R1/R2)$. Keep the loop between Vout and FB as short as possible to minimize the ripple and noise, which is beneficial to the stability and output ripple
4	$\overline{\text{SHDN}}$	Shutdown Control Pin. Tie this pin above 0.9V to enable the device. Tie below 0.25V to turn off the device
5	V _{IN}	Supply Input Pin. Bypass this pin with a capacitor as close to the device as possible



MICRO POWER STEP-UP DC-DC CONVERTER

AP3015/A

Functional Block Diagram

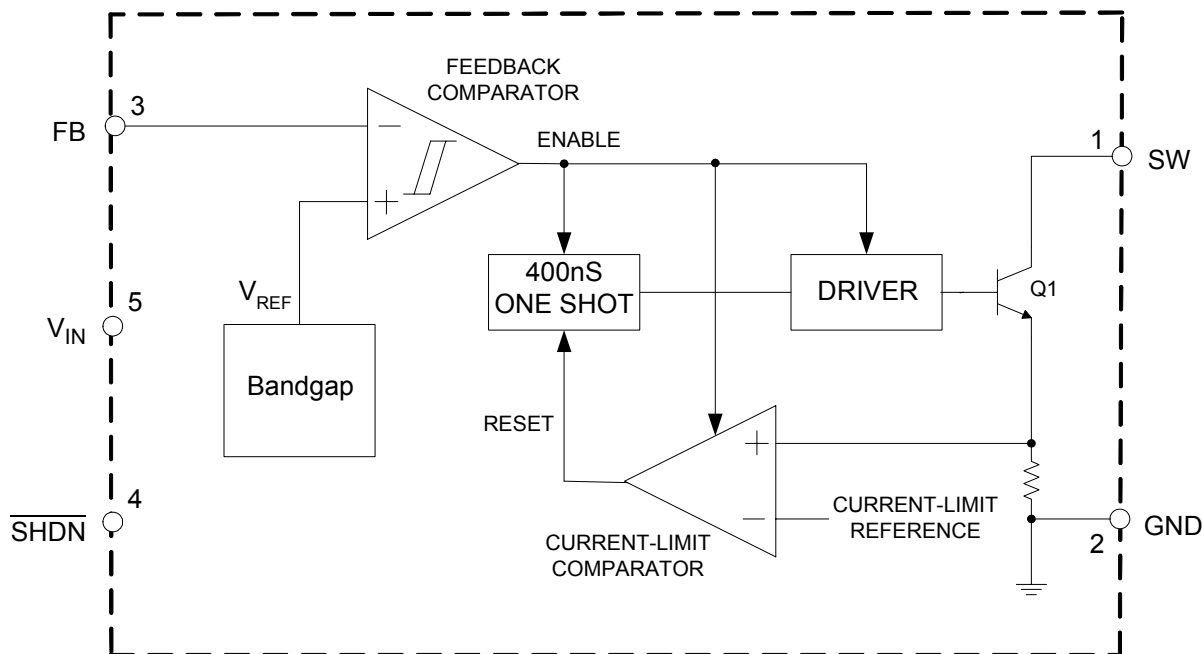
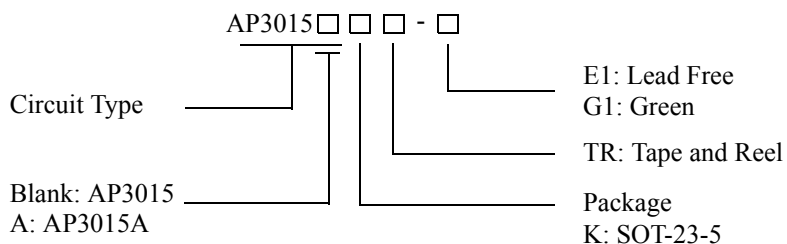


Figure 3. Functional Block Diagram of AP3015/A

Ordering Information



Package	Temperature Range	Part Number		Marking ID		Packing Type
		Lead Free	Green	Lead Free	Green	
SOT-23-5	-40 to 85°C	AP3015KTR-E1	AP3015KTR-G1	E6E	G6E	Tape & Reel
		AP3015AKTR-E1	AP3015AKTR-G1	E6F	G6F	Tape & Reel

BCD Semiconductor's Pb-free products, as designated with "E1" suffix in the part number, are RoHS compliant. Products with "G1" suffix are available in green package.

**MICRO POWER STEP-UP DC-DC CONVERTER****AP3015/A****Absolute Maximum Ratings (Note 1)**

Parameter	Symbol	Value	Unit
Input Voltage	V_{IN}	15	V
SW Voltage	V_{SW}	38	V
FB Voltage	V_{FB}	V_{IN}	V
SHDN Pin Voltage	V_{SHDN}	15	V
Thermal Resistance (Junction to Ambient, no Heat sink)	$R_{\theta JA}$	265	°C/W
Operating Junction Temperature	T_J	150	°C
Storage Temperature Range	T_{STG}	-65 to 150	°C
Lead Temperature (Soldering, 10sec)	T_{LEAD}	260	°C
ESD (Human Body Model)		3000	V

Note 1: Stresses greater than those listed under "Absolute Maximum Ratings" may cause permanent damage to the device. These are stress ratings only, and functional operation of the device at these or any other conditions beyond those indicated under "Recommended Operating Conditions" is not implied. Exposure to "Absolute Maximum Ratings" for extended periods may affect device reliability.

Recommended Operating Conditions

Parameter	Symbol	Min	Max	Unit	
Input Voltage	V_{IN}	AP3105	1.2	12	V
		AP3105A	1.0	12	
Operating Temperature	T_A	-40	85	°C	



MICRO POWER STEP-UP DC-DC CONVERTER

AP3015/A

Electrical Characteristics

($V_{IN}=V_{\overline{SHDN}}=1.2V$, $T_A=25^{\circ}C$, unless otherwise specified.)

Parameter	Symbol	Conditions	Min	Typ	Max	Unit
Input Voltage	V_{IN}	AP3015	1.2		12	V
		AP3015A	1.0		12	
Quiescent Current	I_Q	Not Switching		17	30	μA
		$V_{\overline{SHDN}}=0V$			1	
Feedback Voltage	V_{FB}		1.205	1.23	1.255	V
FB Comparator Hysteresis	V_{FBH}			8		mV
FB Pin Bias Current	I_{FB}	$V_{FB}=1.23V$		30	80	nA
Output Voltage Line Regulation	L_{NR}	$1.2V < V_{IN} < 12V$		0.05	0.1	%/V
Switching Current Limit	I_L	AP3015	300	350	400	mA
		AP3015A	75	100	125	
Switch Saturation Voltage	V_{CESAT}	AP3015, $I_{SW}=300mA$		200	300	mV
		AP3015A, $I_{SW}=70mA$		70	120	
Switch Off Time	T_{OFF}	$V_{FB} > 1V$		400		nS
		$V_{FB} < 0.6V$		1.5		μS
\overline{SHDN} Input Threshold High	V_{TH}		0.9			V
\overline{SHDN} Input Threshold Low	V_{TL}				0.25	
\overline{SHDN} Pin Current	$I_{\overline{SHDN}}$	$V_{\overline{SHDN}}=1.2V$		2	3	μA
		$V_{\overline{SHDN}}=5V$		8	12	
Switch Leakage Current	I_{SWL}	Switch Off, $V_{SW}=5V$		0.01	5	μA
Thermal Resistance (Junction to Case)	θ_{JC}			52		$^{\circ}C/W$



MICRO POWER STEP-UP DC-DC CONVERTER

AP3015/A

Typical Performance Characteristics

Unless otherwise noted, $V_{IN}=1.2V$

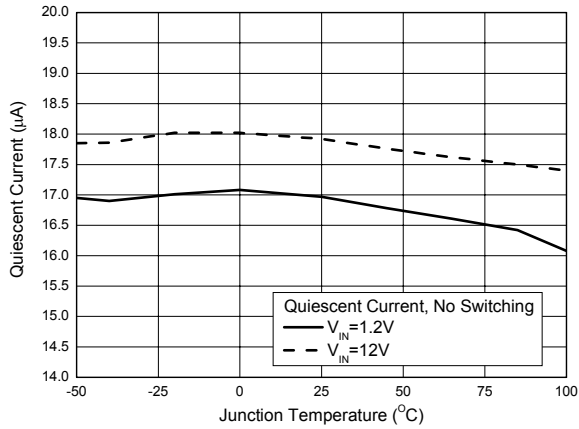


Figure 4. Quiescent Current vs. Junction Temperature

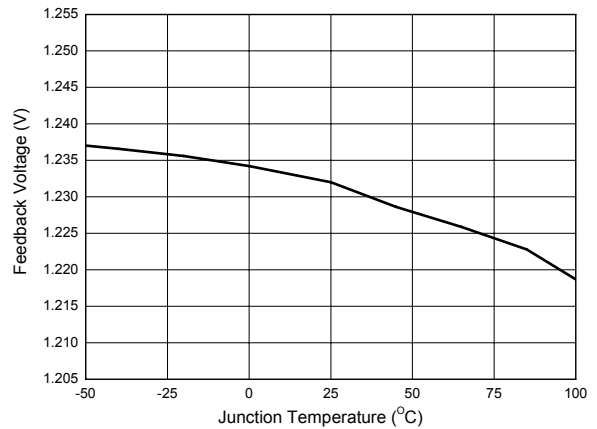


Figure 5. Feedback Voltage vs. Junction Temperature

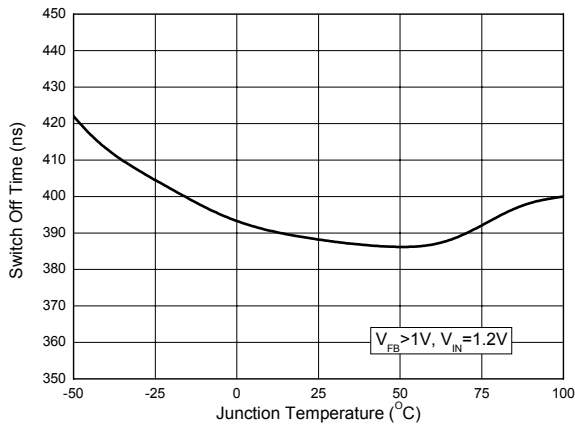


Figure 6. Switch Off Time vs. Junction Temperature

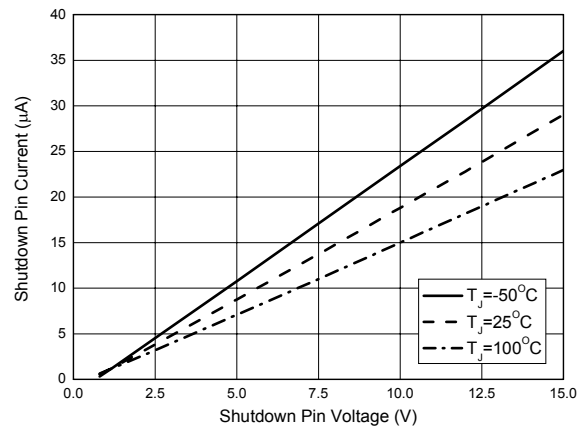


Figure 7. Shutdown Pin Current vs. Shutdown Pin Voltage



MICRO POWER STEP-UP DC-DC CONVERTER

AP3015/A

Typical Performance Characteristics (Continued)

Unless otherwise noted, $V_{IN}=1.2V$

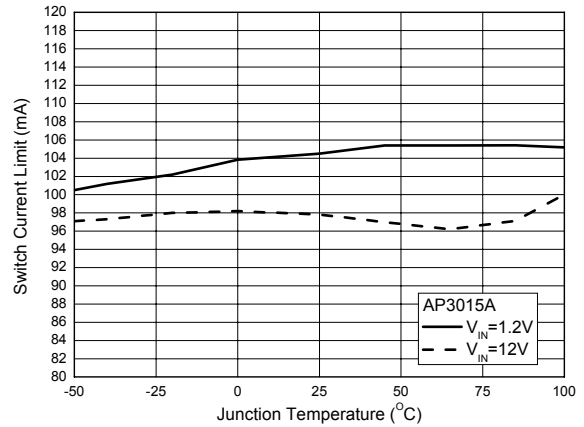
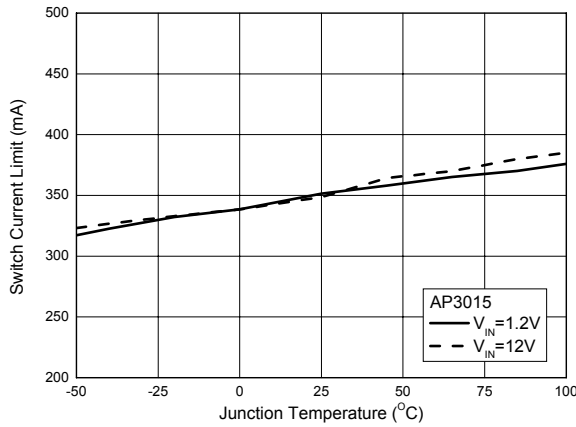


Figure 8. Switch Current Limit vs. Junction Temperature Figure 9. Switch Current Limit vs. Junction Temperature

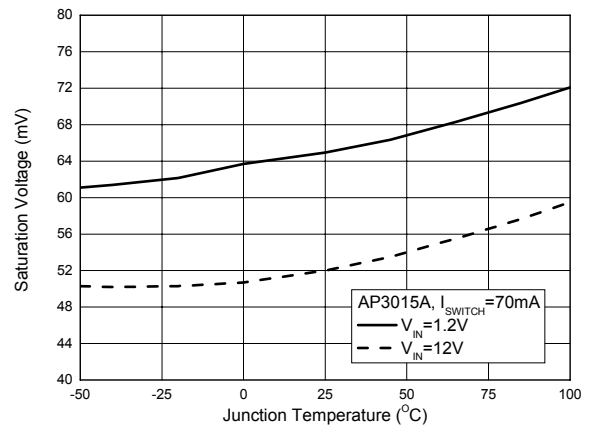
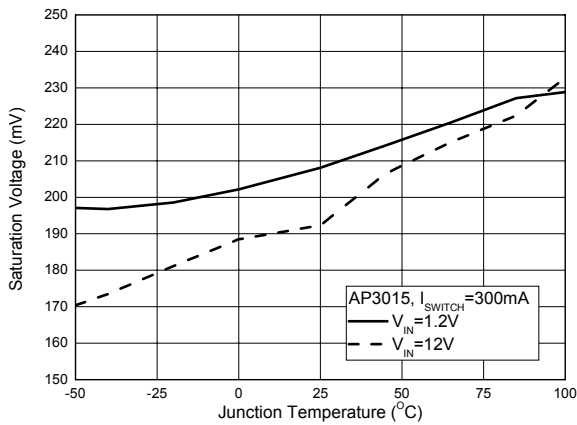


Figure 10. Saturation Voltage vs. Junction Temperature Figure 11. Saturation Voltage vs. Junction Temperature

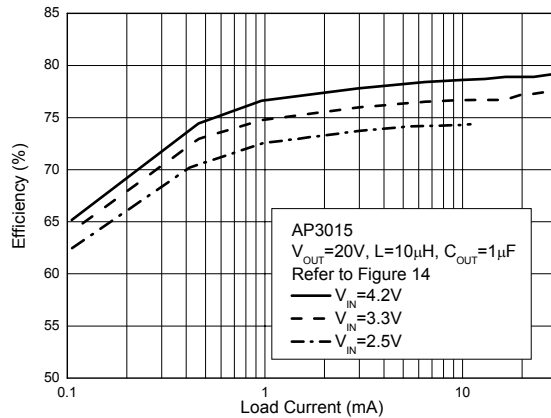
**MICRO POWER STEP-UP DC-DC CONVERTER****AP3015/A****Typical Performance Characteristics (Continued)**Unless otherwise noted, $V_{IN}=1.2V$ 

Figure 12. Efficiency

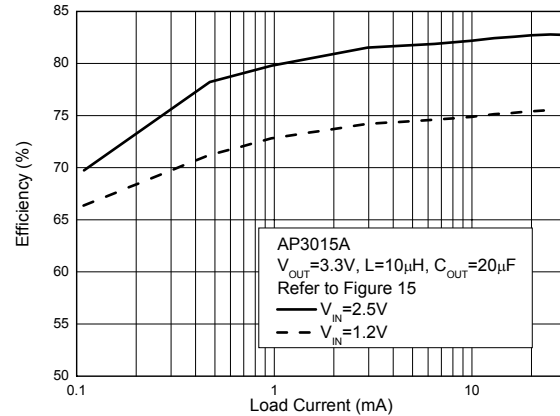


Figure 13. Efficiency

Application Information**Operating Principles**

AP3015/A feature a constant off-time control scheme. Refer to Figure 3, the bandgap voltage V_{REF} (1.23V typical) is used to control the output voltage.

When the voltage at the FB pin drops below the lower hysteresis point of Feedback Comparator (typical hysteresis is 8mV), the Feedback Comparator enables the chip and the NPN power switch is turned on, the current in the inductor begins to ramp up and store energy in the coil while the load current is supplied by the output capacitor. Once the current in the inductor reaches the current limit, the Current-Limit Comparator resets the 400ns One-Shot which turns off the NPN switch for 400ns. The SW voltage rises to the output voltage plus a diode drop and the inductor current begins to ramp down. During this time the energy stored in the inductor is transferred to C_{OUT} and the load. After the 400ns off-time, the NPN switch is turned on and energy will be stored in the inductor again.

This cycle will continue until the voltage at FB pin reaches 1.23V, the Feedback Comparator disables the

chip and turns off the NPN switch. The load current is then supplied solely by output capacitor and the output voltage will decrease. When the FB pin voltage drops below the lower hysteresis point of Feedback Comparator, the Feedback Comparator enables the device and repeats the cycle described previously. Under not switching condition, the I_Q of the device is about 17µA.

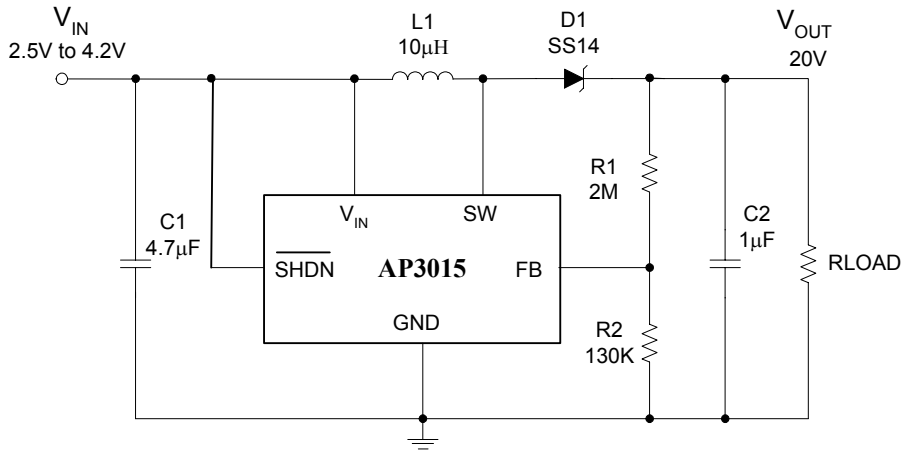
The AP3015/A contain additional circuitry to provide protection during start-up or under short-circuit conditions. When the FB pin voltage is lower than approximately 0.6V, the switch off-time is increased to 1.5µs and the current limit is reduced to about 250mA (70mA for AP3015A). This reduces the average inductor current and helps to minimize the power dissipation in the AP3015/A power switch, in the external inductor and in the diode.

The \overline{SHDN} pin can be used to turn off the AP3015/A and reduce the I_Q to less than 1µA. In shutdown mode the output voltage will be a diode drop below the input voltage.

MICRO POWER STEP-UP DC-DC CONVERTER

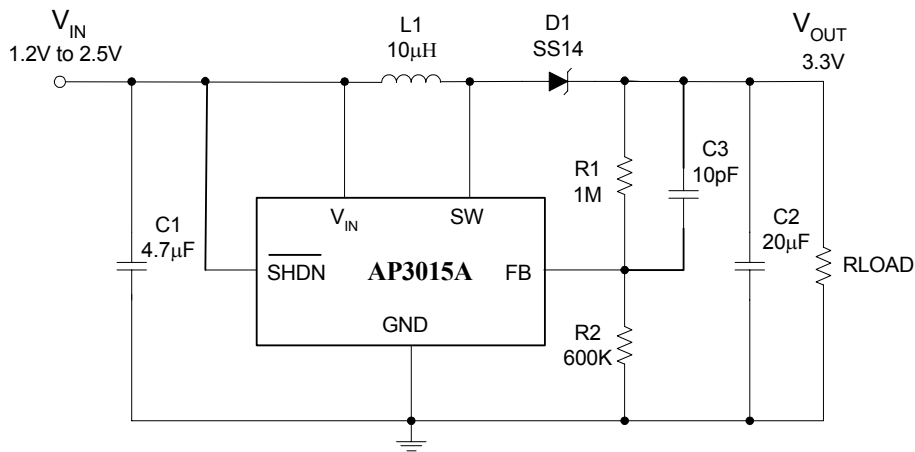
AP3015/A

Typical Application



C1, C2: X5R or X7R Ceramic Capacitor
 L1: SUMIDA CDRH4D16FB/NP-100MC or Equivalent

Figure 14. AP3015 Typical Application in LCD/OLED Bias Supply



C1, C2, C3: X5R or X7R Ceramic Capacitor
 L1: SUMIDA CDRH4D16FB/NP-100MC or Equivalent

Figure 15. AP3015A Typical Application in 1 or 2 Cells to 3.3V Boost Converter



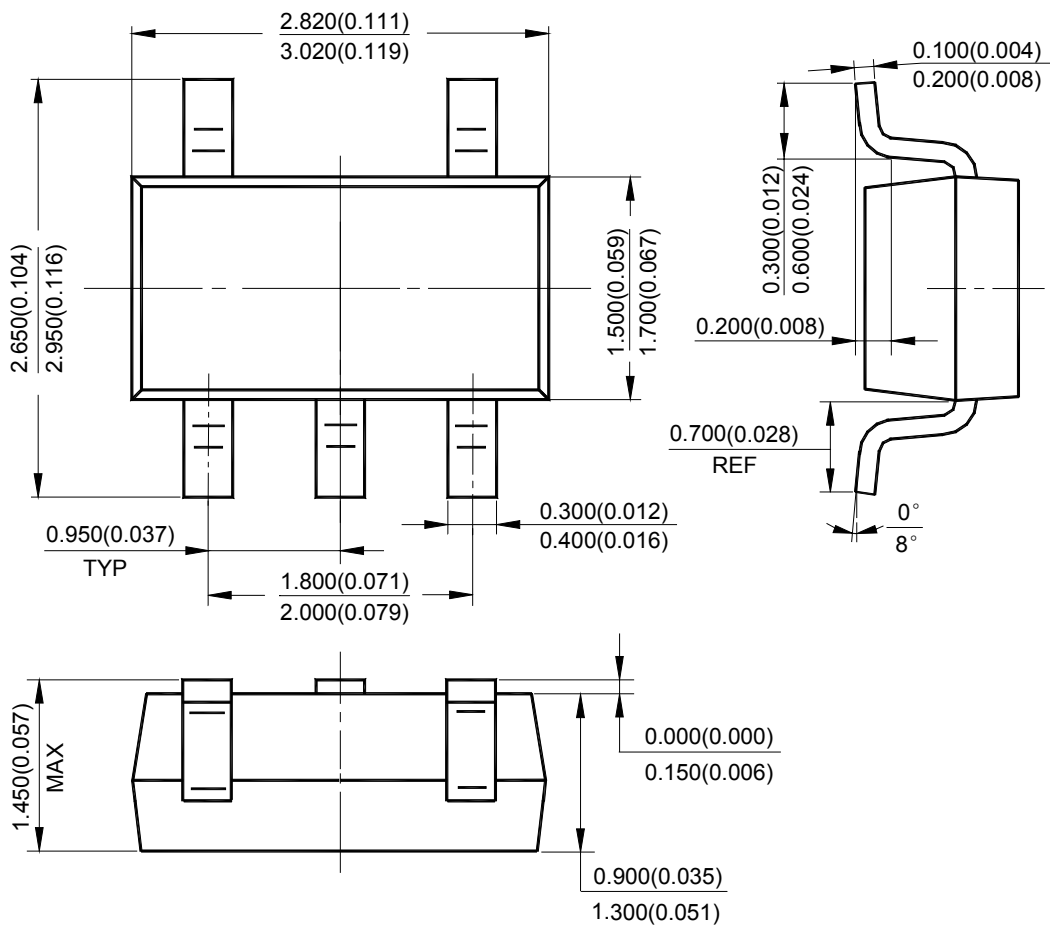
MICRO POWER STEP-UP DC-DC CONVERTER

AP3015/A

Mechanical Dimensions

SOT-23-5

Unit: mm(inch)





BCD Semiconductor Manufacturing Limited

<http://www.bcdsemi.com>

IMPORTANT NOTICE

BCD Semiconductor Manufacturing Limited reserves the right to make changes without further notice to any products or specifications herein. BCD Semiconductor Manufacturing Limited does not assume any responsibility for use of any its products for any particular purpose, nor does BCD Semiconductor Manufacturing Limited assume any liability arising out of the application or use of any its products or circuits. BCD Semiconductor Manufacturing Limited does not convey any license under its patent rights or other rights nor the rights of others.

MAIN SITE

- Headquarters

BCD Semiconductor Manufacturing Limited

No. 1600, Zi Xing Road, Shanghai Zizhu Science-based Industrial Park, 200241, China
Tel: +86-21-24162266, Fax: +86-21-24162277

- Wafer Fab

Shanghai SIM-BCD Semiconductor Manufacturing Co., Ltd.

800 Yi Shan Road, Shanghai 200233, China
Tel: +86-21-6485 1491, Fax: +86-21-5450 0008

REGIONAL SALES OFFICE

Shenzhen Office

Shanghai SIM-BCD Semiconductor Manufacturing Co., Ltd., Shenzhen Office

Unit A Room 1203, Skyworth Bldg., Gaoxin Ave. 1.S., Nanshan District, Shenzhen, China
Tel: +86-755-8826 7951
Fax: +86-755-8826 7865

Taiwan Office

BCD Semiconductor (Taiwan) Company Limited

4F, 298-1, Rui Guang Road, Nei-Hu District, Taipei, Taiwan
Tel: +886-2-2656 2808
Fax: +886-2-2656 2806

USA Office

BCD Semiconductor Corp.

30920 Huntwood Ave. Hayward, CA 94544, USA
Tel : +1-510-324-2988
Fax: +1-510-324-2788