

C-13-DFB2.5-T/R/PX-SXXXX/XXX-X

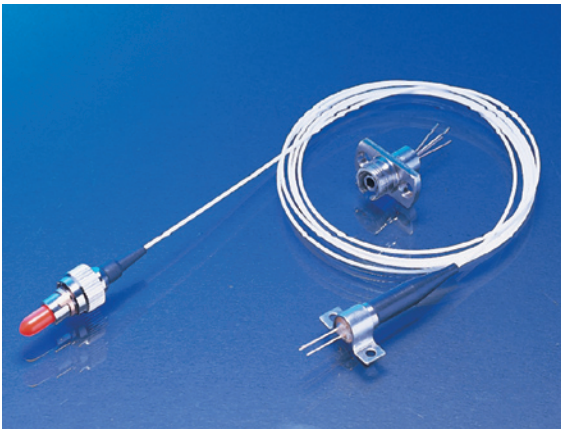

Features

- Un-cooled laser diode with MQW structure
- High temperature operation without active cooling
- Hermetically sealed active component
- Built-in InGaAs monitor photodiode
- Complies with Bellcore TA-NWT-000983
- Single frequency operation with high SMSR
- TOSA package
- FC/ST/SC receptacle package with 2-hole flange
- Fiber pigtailed package with optional FC/ST/SC/MU/LC connector
- Design for 2.5G high speed optic networks application

Absolute Maximum Rating (Tc=25°C)

Parameter	Symbol	Value	Unit
Fiber Output Power L/M/H/2	P_f	1(L)/1.5(M)/2.5(H)/3(2)	mW
LD Reverse Voltage	V_{RLD}	2	V
PD Reverse Voltage	V_{RPD}	10	V
PD Forward Current	I_{FPD}	2.0	mA
Operating Temperature	T_{opr}	0 to +70	°C
Storage Temperature	T_{stg}	-40 to +85	°C

(All optical data refer to a coupled 9/125μm SM fiber)

Optical and Electrical Characteristics (T=25°C)

Parameter	Symbol	Min	Typical	Max	Unit	Test Condition
Threshold Current	I_{th}	-	10	15	mA	CW
Fiber Output Power L M H 2	P_f	0.2 0.5 1 2	- - 1.6 2.5	0.5 1 - -	mW	CW, $I_{th}+20mA$, kink free
Peak Wavelength	λ	1295	1310	1325	nm	Note 3
Side mode Suppression Ratio	S_r	30	35	-	dB	CW, $P_f=P_f(\text{Min})$, 0 to 70°C
Forward Voltage	V_f	-	1.2	1.5	V	CW, $P_f=P_f(\text{Min})$
Rise/Fall Time	t_r/t_f	-	-	150	ps	$I_{bias}=I_{th}$, 10% to 90%
Tracking Error	$\Delta P_f / P_f$	-	-	±1.5	dB	APC, 0 to +70°C
PD Monitor Current	I_m	100	-	-	μA	CW, $P_f=P_f(\text{Min})$, $V_{RPD}=2V$
PD Dark Current	I_{DARK}	-	-	0.1	μA	$V_{RPD}=5V$
PD Capacitance	C_t	-	6	15	pF	$V_{RPD}=5V$, $f=1MHz$

Ordering Information

C-13-DFB2.5-XD-SXXXX/XXX-X

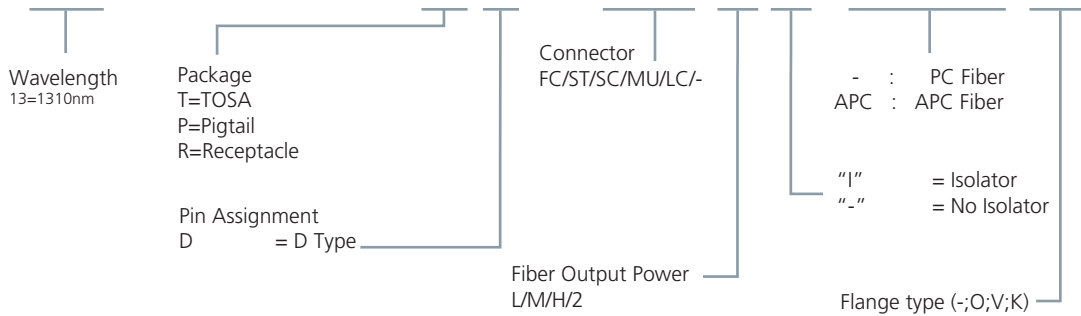

Pin Assignment

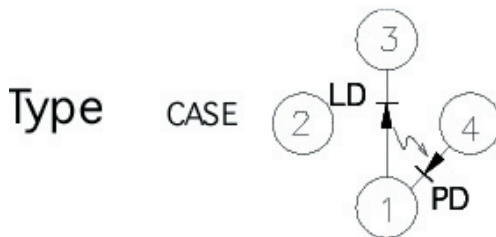

- P in1 : Laser Anode and Monitor Diode Cathode
- P in2 : Case Gnd
- P in3 : Laser Cathode
- P in4 : Monitor Diode Anode

Packaging Dimension (Receptacle)

DFB LD Module- receptacle

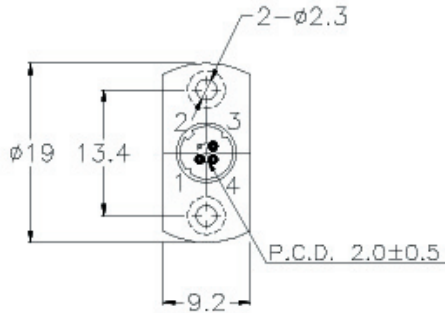

Part Number: C-13-DFB2.5-RD-SXXXX

Units in mm

metal

FC Receptacle

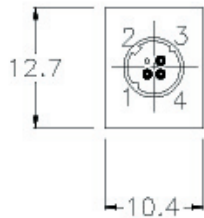
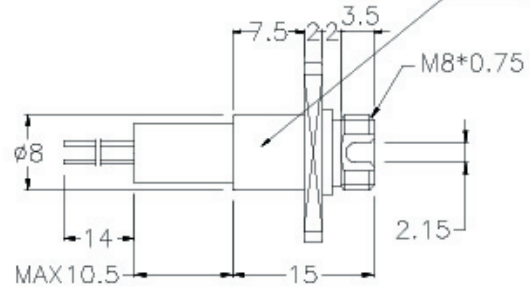

ST Receptacle

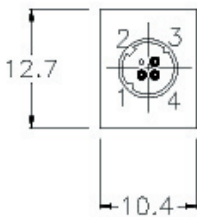
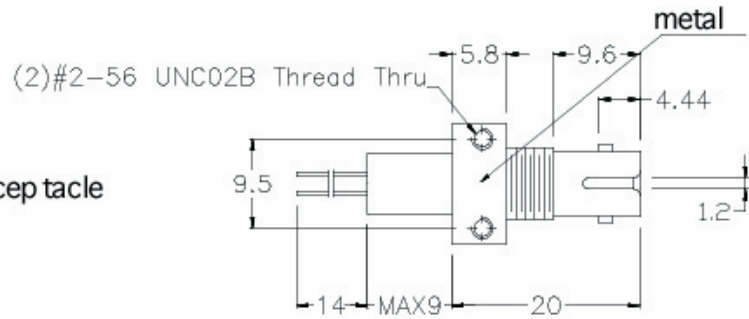

ST Receptacle

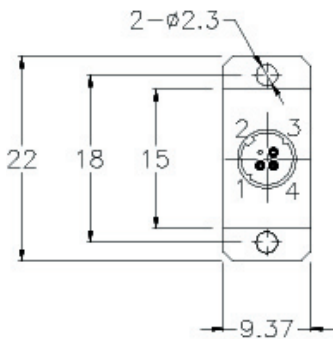
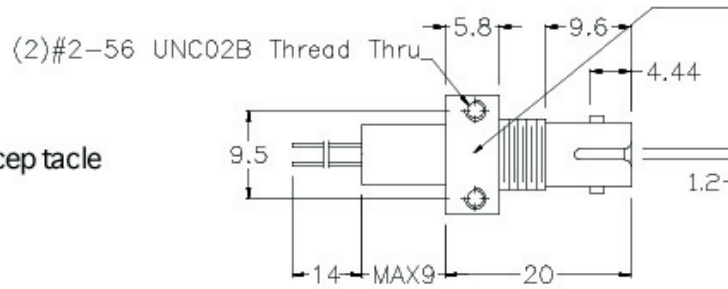

SC Receptacle

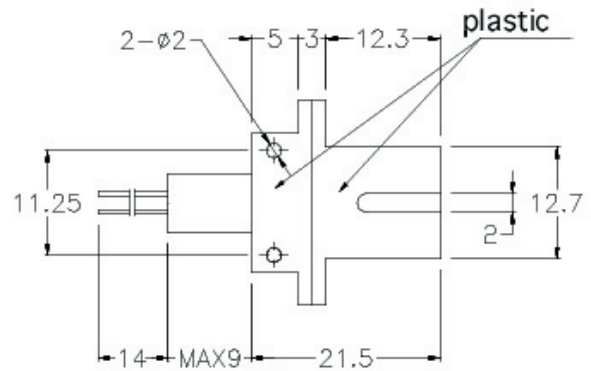

C-13-DFB2.5-T/R/PX-SXXXX/XXX-X

Packaging Dimension (TOSA)

2.5G DFB LD Module- TOSA

Part Number: C-13-DFB2.5-TX-SLCXX

Units in mm

P.C.D. 2.0±0.5

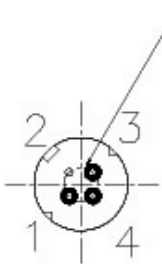

LC TOSA (L&M Power)
C-13-DFB2.5-TX-SLCX

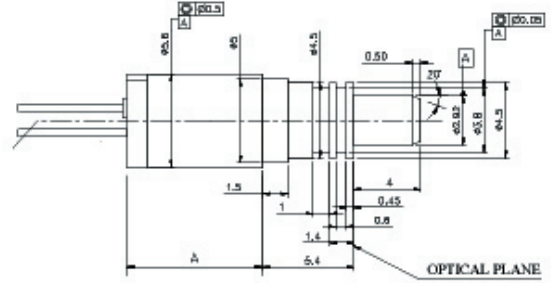

DIMENSION A: 7.77~8.37mm

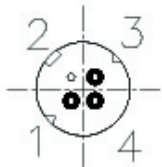

LC TOSA (L&M Power with Isolator)
C-13-DFB2.5-TX-SLCXI

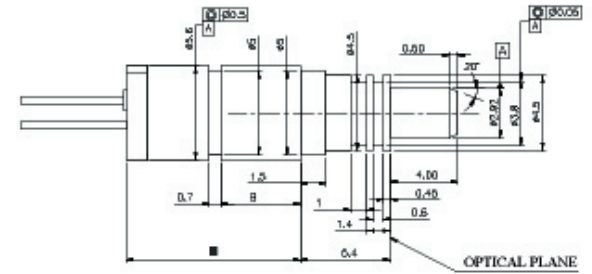

DIMENSION A: 8.07~9.07mm
DIMENSION B: 2.8~3.8mm



LC TOSA (H&2 Power)
C-13-DFB2.5-TX-SLCXX

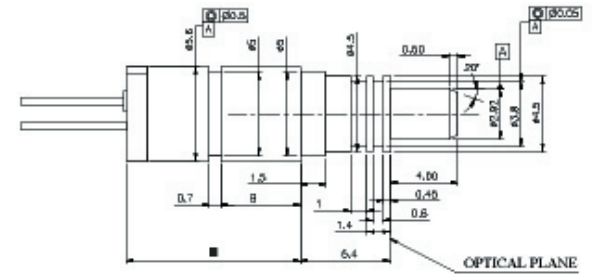

DIMENSION A: 9.7~11mm
DIMENSION B: 2.9~4.2mm

C-13-DFB2.5-T/R/PX-SXXXX/XXX-X

Packaging Dimension (TOSA)

2.5G DFB LD Module- Pigtailed

Part Number: C-13-DFB2.5-PX-SXXXX/XXX-X

Units in mm

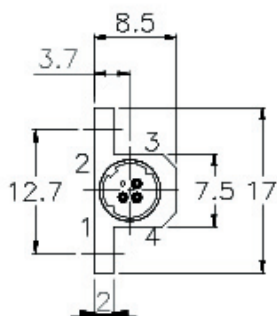
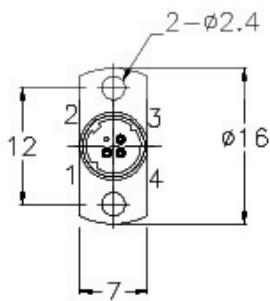
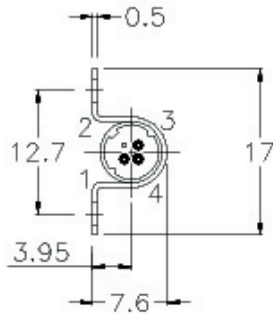
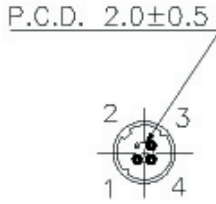

Flange Type

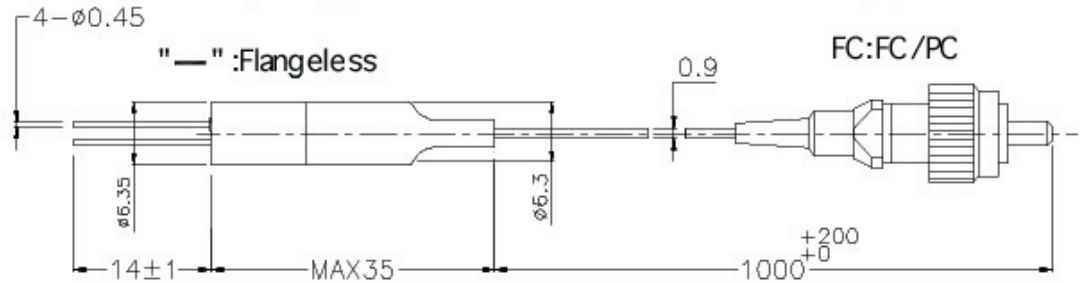

Connector Type

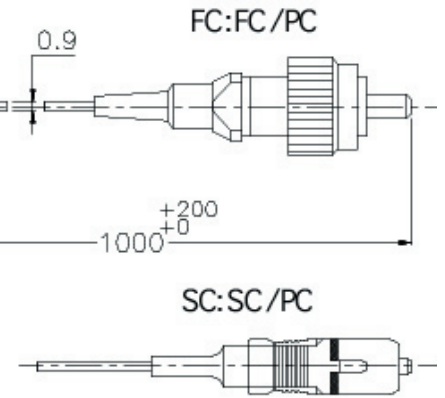

SC:SC/PC

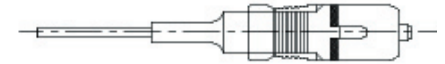

"O": Horizontal (Omega Housing)

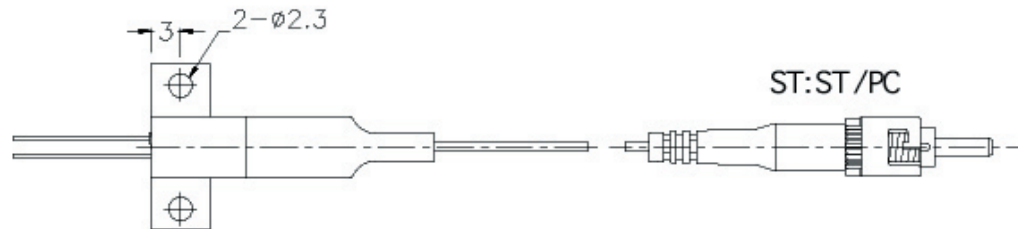

ST:ST/PC

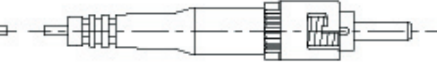

MU: MUJ/PC



"V": Vertical

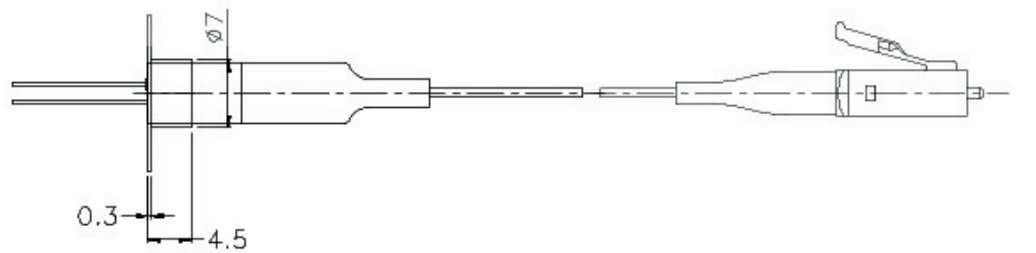

LC:LC/PC

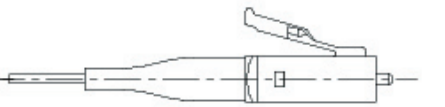

"K": Horizontal (KX Housing)

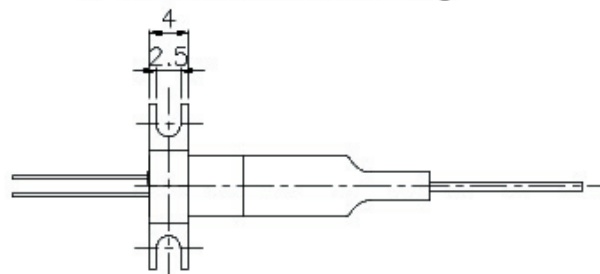

Warnings

Handling Precautions: This device is susceptible to damage as a result of electrostatic discharge (ESD). A static free environment is highly recommended. Follow guidelines according to proper ESD procedures.

Laser Safety: Radiation emitted by laser devices can be dangerous to human eyes. Avoid eye exposure to direct or indirect radiation.

Legal Notice

IMPORTANT NOTICE!

All information contained in this document is subject to change without notice, at Luminent's sole and absolute discretion. Luminent warrants performance of its products to current specifications only in accordance with the company's standard one-year warranty; however, specifications designated as "preliminary" are given to describe components only, and Luminent expressly disclaims any and all warranties for said products, including express, implied, and statutory warranties, warranties of merchantability, fitness for a particular purpose, and non-infringement of proprietary rights. Please refer to the company's Terms and Conditions of Sale for further warranty information.

Luminent assumes no liability for applications assistance, customer product design, software performance, or infringement of patents, services, or intellectual property described herein. No license, either express or implied, is granted under any patent right, copyright, or intellectual property right, and Luminent makes no representations or warranties that the product(s) described herein are free from patent, copyright, or intellectual property rights. Products described in this document are NOT intended for use in implantation or other life support applications where malfunction may result in injury or death to persons. Luminent customers using or selling products for use in such applications do so at their own risk and agree to fully defend and indemnify Luminent for any damages resulting from such use or sale.

THE INFORMATION CONTAINED IN THIS DOCUMENT IS PROVIDED ON AN "AS IS" BASIS. Customer agrees that Luminent is not liable for any actual, consequential, exemplary, or other damages arising directly or indirectly from any use of the information contained in this document. Customer must contact Luminent to obtain the latest version of this publication to verify, before placing any order, that the information contained herein is current.

© Luminent, Inc. 2003
All rights reserved